

OPERATOR'S MANUAL



CLASS PAYS

Safety

1

Emergency

2

Controls

3

Driving

4

Maintenance

5

Information

6

© 2018 PACCAR Inc. - All Rights Reserved

This manual illustrates and describes the operation of features or equipment which may be either standard or optional on this vehicle. This manual may also include a description of features and equipment which are no longer available or were not ordered on this vehicle. Please disregard any illustrations or descriptions relating to features or equipment which are not on this vehicle. PACCAR reserves the right to discontinue, change specifications, or change the design of its vehicles at any time without notice and without incurring any obligation. The information contained in this manual is proprietary to PACCAR. Reproduction, in whole or in part, by any means is strictly prohibited without prior written authorization from PACCAR Inc.

Chapter 1 | SAFETY

In this Chapter:

Applies To.....	6
Using this Manual.....	6
Safety Alerts.....	7
Illustrations.....	8
General Safety Instructions.....	8
Data Recorder.....	11
Environmental Protection Agency.....	11
A Special Word About Repairs.....	12
Additional Sources of Information.....	12
Cab Access.....	13
How to Access the Upper Bunk.....	15
Deckplate Access.....	21
How to open the hood.....	22
Seat.....	24

What to do before starting the vehicle.....	33
Vehicle Loading.....	35
Visual inspection while approaching the vehicle.....	36
Daily Checks.....	36
Weekly Checks.....	38

Applies To

579,567

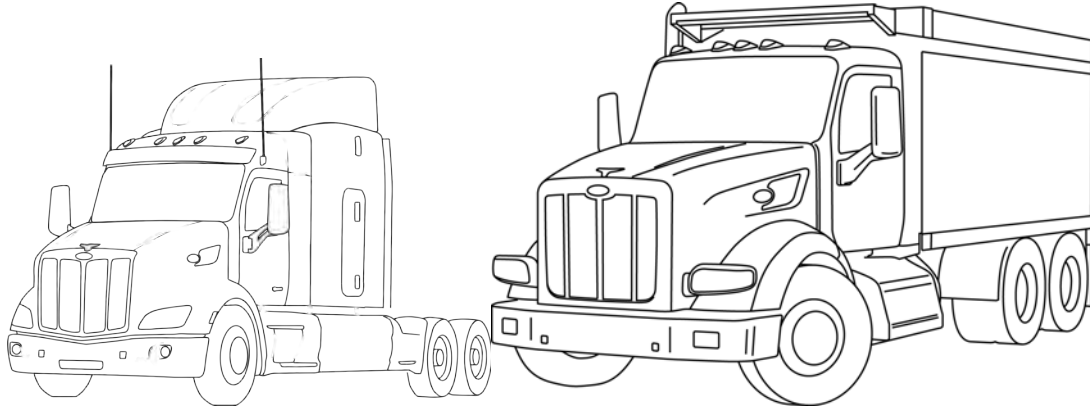

Using this Manual

Please take the time to get acquainted with your vehicle by reading this Operator's Manual. We recommend that you read and understand this manual from beginning to end before you operate this equipment.

This manual contains useful information for the safe and efficient operation of this equipment. It also provides service information, with an outline for performing safety checks and basic preventive maintenance inspections. We have tried to present the information you'll need to learn about functions, controls, and operation—and to present it as clearly as possible. We hope you'll find this manual easy to use.

There will be times when you need to take this manual out of the glovebox. When you do, please be sure to return it when you are finished using it. That way it will be there when you need it the next time or when you pass the vehicle on to the next user.

**NOTE**

After you've read this manual, it should be stored in the cab for convenient reference and remain with this truck when sold.

Your vehicle may not have all the features or options mentioned in this manual. Therefore, you should pay careful attention to the instructions that pertain to just your vehicle. In addition, if your vehicle is equipped with special equipment or options not discussed in this manual, consult your dealer or the manufacturer of the equipment.

There are several tools built into this manual to help you find what you need quickly and easily. First is the Quick Table of Contents. Located at the front of the manual, this lists the main subjects covered and gives section numbers where you can find these subjects. Use the Quick Table of Contents to find information on a large subject like "Maintenance." Cross-referenced citations also help you get the information you need. If some other part of the manual contains further information on the subject you are reading about, we'll

indicate that in a cross-reference like this: (See [Safety Alerts](#) on page 7). You won't have to go searching for more information. Finally you'll find a helpful Subject Index. It's in the back of the manual and alphabetically lists the subjects covered. So if you want information on brakes, for example, just look under Brake in the Subject Index. You'll find all the pages listed where brakes or braking are discussed.

All information contained in this manual is based on the latest production information available at the time of publication. Peterbilt Motors Company reserves the right to make changes at any time without notice.

Safety Alerts

Please read and follow all of the safety alerts contained in this manual. They are there for your protection and information. These alerts can help you avoid injury to yourself, your passengers and help prevent costly damage to the vehicle. Safety alerts are highlighted by safety alert symbols and signal words such as "WARNING",

"CAUTION", or "NOTE". Please DO NOT ignore any of these alerts.

Warnings



The safety message following this symbol and signal word provides a warning against operating procedures which could cause death or injury. They could also cause equipment or property damage. The alert will identify the hazard, how to avoid it and the probable consequence of not avoiding the hazard.

**WARNING**

Hot engine oil can be dangerous. You could be burned. Let the engine oil cool down before changing it. Failure to comply may result in death, personal injury, equipment or property damage.

Cautions



The safety message following this symbol and signal word provides a caution against operating procedures which could cause equipment or property damage. The alert will identify the hazard, how to avoid it, and the probable consequence of not avoiding the hazard.

**CAUTION**

Continuing to operate your vehicle with insufficient oil pressure will cause serious engine damage. Failure to comply may result in equipment or property damage.

Notes

The message following this symbol and signal word provides important information that is not safety related but should be followed. The alert will highlight things that may not be obvious and is useful to your efficient operation of the vehicle.

**NOTE**

Pumping the accelerator will not assist in starting the engine.

Illustrations

Some of the illustrations throughout this manual are generic and will NOT look exactly like the engine or parts used in your application. The illustrations can contain symbols to indicate an action required and/or an acceptable or NOT acceptable condition.

The illustrations are intended to show repair or replacement procedures. The procedure will be the same for all applications, although the illustration may differ.

General Safety Instructions

Important safety notices about operating and servicing your engine.

**WARNING**

Improper practices, carelessness, or ignoring any warnings may cause death, personal injury, equipment or property damage.

Before performing any repair, read and understand all of the safety precautions and warnings. The following is a list of general safety precautions that must be followed to provide personal safety. Failure to follow these instructions may cause death or injury. Special safety precautions are included in the procedures when they apply.

Keep in mind that even a well maintained vehicle must be operated within the range of its mechanical capabilities and the limits of its load ratings. See the Weight Ratings label on the driver's door edge.

Every new vehicle is designed to conform to all Federal Motor Vehicle Safety Standards applicable at the time of manufacture. Even with these safety features, continued safe and reliable operation depends greatly upon regular vehicle maintenance. Follow the maintenance recommendations found in

Preventive Maintenance section. This will help preserve your investment. Make sure your vehicle is in top working condition before heading out on the road, it is the responsible driver's duty to do so. Inspect the vehicle according to the Driver's Check List.

- Use the proper tool for manually rotating the engine. DO NOT attempt to rotate the crankshaft by pulling or prying on the fan. This practice can cause death, personal injury, equipment damage, or damage to the fan blades, causing premature fan failure.
- Work areas should be dry, well lit, well ventilated, free from clutter, loose tools, parts, ignition sources and hazardous substances.
- Wear protective glasses and protective shoes when working.
- DO NOT wear loose-fitting or torn clothing. Tie back and/or tuck in long hair. Remove all jewelry when working.
- Before beginning any repair, disconnect the battery (negative [-] cable) and discharge any capacitors.

- Put a "DO NOT OPERATE" tag in the operator's compartment or on the controls.
- Allow the engine to cool before slowly loosening the coolant filler cap to relieve the pressure from the cooling system.

WARNING

Removing the fill cap on a hot engine can cause scalding coolant to spray out and burn you badly. If the engine has been in operation within the previous 30 minutes, be very careful in removing the fill cap. Protect face, hands, and arms against escaping fluid and steam by covering the cap with a large, thick rag. DO NOT try to remove it until the surge tank cools down or if you see any steam or coolant escaping. In any situation, remove the cap very slowly and carefully. Be ready to back off if any steam or coolant begins to escape.

- Always use wheel chocks or proper jack stands to support the vehicle or vehicle components before performing any service work. DO

NOT work on anything that is supported only by lifting jacks or a hoist. Before resting a vehicle on jack stands, be sure the stands are rated for the load you will be placing on them.

- Before removing or disconnecting any lines, fittings, or related items, relieve all pressure in the air, oil, fuel, and cooling systems. Remain alert for possible pressure when disconnecting any device from a system that contains pressure. High pressure oil or fuel can cause death or personal injury.
- Always wear protective clothing when working on any refrigerant lines and make sure that the workplace is well ventilated. Inhalation of fumes can cause death or personal injury. To protect the environment, liquid refrigerant systems must be properly emptied and filled using equipment that prevents the release of refrigerant gas. Federal law requires capturing and recycling refrigerant.
- When moving or lifting any heavy equipment or parts, make sure to use proper techniques and assistance. Ensure all lifting

devices such as chains, hooks, or slings are in good condition and are of the correct load capacity. Make sure all lifting devices are positioned correctly.

- Corrosion inhibitors and lubricating oils may contain alkali. DO NOT get the substance in eyes and avoid prolonged or repeated contact with skin. DO NOT swallow. If ingested, seek immediate medical attention. DO NOT induce vomiting. In case of contact, immediately wash skin with soap and water. In case of harmful contact, immediately contact a physician. Always keep any chemicals OUT OF REACH OF CHILDREN.
- Naptha and Methyl Ethyl Ketone (MEK) are flammable materials and must be used with caution. Follow the manufacturer's instructions to ensure safety when using these materials. Always keep any chemicals OUT OF REACH OF CHILDREN.
- When working on the vehicle, be alert for hot parts on systems that have just been turned off, exhaust gas flow, and hot fluids in lines,

tubes, and compartments. Contact with any hot surface may cause burns.

- Always use tools that are in good condition. Make sure you have the proper understanding of how to use the tools before performing any service work. Use only genuine replacement parts from PACCAR.
- Always use the same fastener part number (or equivalent) when replacing items. DO NOT use a fastener of lesser quality if replacements are necessary. (e.g., Do not replace a 10.9 grade with 8.8 grade fastener.)
- Always torque fasteners and fuel connections to the required specifications. Overtightening or under-tightening can allow leakage.
- Close the manual fuel valves prior to performing maintenance and repairs, and when storing the vehicle inside.
- DO NOT perform any repair when impaired, tired, fatigued or after consuming alcohol or drugs that can impair your functioning.
- Some state and federal agencies in the United States of America have

determined that used engine oil can be carcinogenic and can cause reproductive toxicity. Avoid inhalation of vapors, ingestion, and prolonged contact with used engine oil.

- DO NOT connect the jump starting or battery charging cables to any ignition or governor control wiring. This can cause electrical damage to the ignition or governor.
- Coolant is toxic. If not reused, dispose of coolant in accordance with local environmental regulations.



CAUTION

Corrosive chemicals can damage the engine. DO NOT use corrosive chemicals on the engine. Failure to comply may result in equipment, or property damage.

California Proposition 65 Warning

- Diesel engine exhaust and some of its constituents are known to the State of California to cause cancer, birth defects, and other reproductive harm.

- The catalyst substrate located in the Diesel Particulate Filter (DPF) contains vanadium pentoxide, which has been determined by the State of California to cause cancer. Always wear protective clothing and eye protection when handling the catalyst assembly. Dispose of the catalyst in accordance with local regulations. If catalyst material gets into the eyes, immediately flood eyes with water for a minimum of 15 minutes. Avoid prolonged contact with skin. In case of contact, immediately wash skin with soap and water. In case of harmful contact, immediately contact a physician.
- Other chemicals in this vehicle are also known to the State of California to cause cancer, birth defects or other reproductive harm.
- Battery posts, terminals, and related accessories contain lead and lead compounds, chemicals known to the State of California to cause cancer and reproductive harm. Wash hands after handling.

Data Recorder

California Vehicle Code - Section 9951- Disclosure of Recording Device

Your vehicle may be equipped with one or more recording devices commonly referred to as "event data recorders" (EDR) or "sensing and diagnostic modules" (SDM). If you are involved in an accident, the device(s) may have the ability to record vehicle data that occurred just prior to and/or during the accident. For additional information on your rights associated with the use of this data, contact:

- The California Department of Motor Vehicles - Licensing Operations Division
- <http://www.dmv.ca.gov/>

Environmental Protection Agency

Information on use and disposal of hazardous materials.

Some of the ingredients in engine oil, hydraulic oil, transmission and axle oil,

engine coolant, diesel fuel, air conditioning refrigerant (R12, R134a, and PAG oil), batteries, etc., may contaminate the environment if spilled or not disposed of properly.



WARNING

Diesel engine exhaust and some of its constituents are known to the State of California to cause cancer, birth defects, and other reproductive harm. Other chemicals in this vehicle are also known to the State of California to cause cancer, birth defects or other reproductive harm. This warning requirement is mandated by California law (Proposition 65) and does not result from any change in the manner in which vehicles are manufactured.

Contact your local government agency for information concerning proper disposal.

A Special Word About Repairs



WARNING

Do not attempt repair work without sufficient training, service manuals, and the proper tools. You could be killed or injured, or you could make your vehicle unsafe. Do only those tasks you are fully qualified to do.



WARNING

Modifying your vehicle can make it unsafe. Some modifications can affect your vehicle's electrical system, stability, or other important functions. Before modifying your vehicle, check with your dealer to make sure it can be done safely. Improper modifications can cause death or personal injury.



CAUTION

The installation of electronic devices to the On Board Diagnostics (OBD) connector, the vehicle Controller Area Network (CAN), or their associated wiring is not permitted. Doing so can adversely affect vehicle performance and/or cause fault codes to be recorded. The OBD connector is provided for temporary connection of service tools and for diagnostic purposes only.

Your dealer's service center is the best place to have your vehicle repaired. You can find dealers all over the country with the equipment and trained personnel to get you back on the road quickly—and keep you there.

Your vehicle is a complex machine. Anyone attempting repairs on it needs good mechanical training and the proper tools. If you are sure you have these requirements, then you can probably perform some repairs yourself. However, all warranty repairs must be performed by an authorized service facility. If you aren't an experienced mechanic, or don't have the right equipment, please leave all

repairs to an authorized service facility. They are the ones equipped to do the job safely and correctly.

Maintenance Manuals

If you do decide to do any complex repair work, you'll need the maintenance manuals. Order them from your authorized dealer. Please provide your Chassis Serial Number when you order, to be sure you get the correct manuals for your vehicle. Allow about four weeks for delivery. There will be a charge for these manuals.

Final Chassis Bill of Material

A complete, non-illustrated computer printout listing of the parts used to custom-build your vehicle is available through the dealer from whom you purchased your vehicle.

Additional Sources of Information

Major component suppliers also supply operation manuals specific to their products. Additional manuals and other pieces of literature are included in the

glove box literature package. Look for information on products such as the engine, driver's seat, transmission, axles, wheels, tires, ABS/ESC, radio, 5th wheel, lane departure and adaptive cruise control. If you are missing these pieces of literature, ask your dealer for copies. Another place to learn more about trucking is from local truck driving schools. Contact one near you to learn about courses they offer. Federal and state agencies such as the department of licensing also have information. The Interstate Commerce Commission can give you information about regulations governing transportation across state lines.

Cab Access

Guidelines for getting into the cab

WARNING

Always reinstall steps before entering the cab or accessing the deck plate. Without steps you could slip and fall. Failure to comply may result in personal injury or death.

WARNING

Keep steps clean. Clean any fuel, oil, or grease off the steps before entering the cab or accessing the deck plate. Stepping on a slippery surface can cause a fall which may result in death or personal injury.

Be careful whenever you get into or out of your vehicle's cab. Always maintain at least three points of contact with your hands on the grab handles and your feet on the steps. The following picture shows the best way to enter and exit a Conventional Cab.

WARNING

Jumping out of the cab or getting into the cab without proper care is dangerous. You could slip and fall, which could lead to death or personal injury. Keep steps clean. Clean any fuel, oil, or grease off of the steps before entering the cab. Use the steps and grab handles provided, and always keep at least three points of contact between

your hands and feet and the truck. Look where you are going.



How to lock and unlock the cab doors

Information on locking your vehicle.

The vehicle has one key for cab doors, ignition, and the optional sleeper luggage compartment. Frame-mounted tool box locks and locking fuel tank caps each have separate individual keys.



WARNING

To help lessen the chance and/or severity of death or personal injury in case of an accident, always lock the doors while driving. Along with using the lap shoulder belts properly, locking the doors helps prevent doors from inadvertently opening and occupants from being ejected from the vehicle.

To lock or unlock the doors from outside the cab:

1. Insert the key in the lock.
2. Turn the key toward the rear to lock of the vehicle (clockwise); forward (counter clockwise) to unlock.

Remote Keyless Entry

Remote Keyless Entry (RKE) option is a system that adds security and convenience to your vehicle. The system will lock or unlock cab doors with the key fob. The system will alert you with parking lights when the selected doors are locked or unlocked. The system includes two key fobs that provide secure rolling code technology that prevents someone from recording the entry signal.



NOTE

FCC ID: L2C0031T IC: 3432A-0031T
 FCC ID: L2C0032R IC: 3432A-0032R
 This device complies with Part 15 of the FCC Rules and with RSS-210 of Industry Canada. Operation is subject to the following two conditions (1) This device may not cause harmful interference, and (2) This device must accept any interference received, including interference that may cause undesired operation. Changes or modifications not expressly approved by the party responsible for compliance could void the user's authority to operate the equipment. The term IC: before the ra-

dio certification number only signifies that Industry Canada technical specifications were met.

The key fob uses one CR2032, 3V battery. Batteries should last approximately three years, depending on use. Consistently reduced range is an indicator that the battery needs replacement. Batteries are available at most discount, hardware, and drug stores. The battery can be accessed by removing the cover of the key fob. After a new battery is installed, the key fob must be synchronized with the vehicle.

How to replace key fob battery

How to replace the battery in the key fob

If the key fob will not unlock the doors, replace the battery.

1. Remove the cover of the key fob.
2. Replace the battery and dispose of the old battery.
3. Synchronize the key fob with the vehicle.

Operate Door Locks using Remote Keyless Entry

How to use the remote keyless entry key fob.

Open doors will not lock using the key fob. The key fob should be within 30 feet (9 meters) of the vehicle and should not be in proximity of other RF sources such as television, radio or cell phone transmitters. To unlock the cab doors:

1. Press the **UNLOCK** button once. The driver's door will unlock and the parking lights will come on for 40 seconds.
2. Quickly press the **UNLOCK** button a second time within 5 seconds to unlock the passenger door.
3. Press the **LOCK** button. The doors will lock and the parking lights will come on for 2 seconds.

How to Access the Upper Bunk

What is an Upper Bunk Ladder

This vehicle may be equipped with an upper bunk ladder. The ladder enables you to conveniently climb into the upper bunk without stepping on the lower bunk. The ladder can be unfolded when needed. The ladder folds up into the upper bunk structure when not in use, while driving, or when accessing the lower bunk. The ladder can be folded up into the upper bunk.

Ladder Folded and Latched

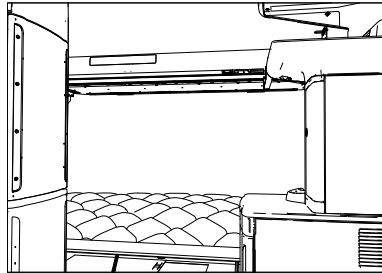

Ladder Partially Unfolded

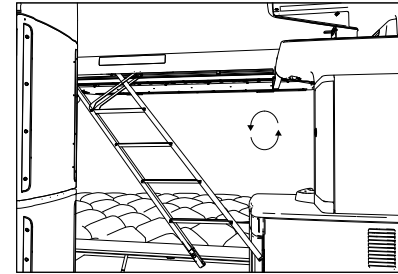

1

Ladder Unfolded

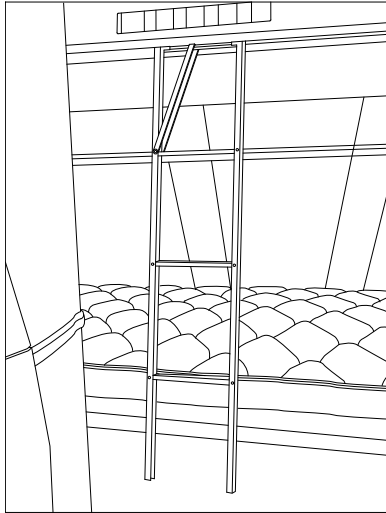

How to Unfold the Upper Bunk Ladder



WARNING

Do not attempt to fold or unfold the ladder while an occupant is in the lower bunk. Allow the lower bunk occupant to vacate the bunk before folding or unfolding the ladder. Failure to do so may result in personal injury.



CAUTION

Upper bunk must be in down position before folding and unfolding the ladder. Always lower the upper bunk before folding and unfolding the ladder. Failure to do so may result in property damage.



CAUTION

Lower bunk must be in down position before folding and unfolding the ladder. Failure to do so may result in property damage.



CAUTION

Make sure floor area is clear prior to folding and unfolding the ladder. There should be nothing between the ladder leg and floor carpet when the ladder is unfolded. Failure to do so may result in property damage.

1. Ensure the lower bunk is in the down position.
2. Lower the upper bunk.
3. Locate the release latch on the driver's side front edge of the upper bunk.

4. Release the ladder by pulling the latch out.

Unlatching the ladder

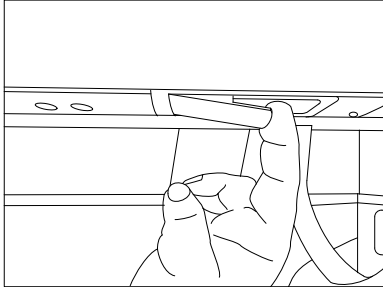

5. Position your left hand, open palm, beside the latch to control the unfolding action of the ladder as it separates from the bunk structure. Maintain contact with your left hand, open palm, in the same position until the ladder is completely unfolded.
6. When the ladder is about half way unfolded, position your right hand, open palm, on the upper right side of the ladder to help guide the ladder into position.



WARNING

Do not grip the ladder while folding and unfolding it. Always use an open hand when folding and unfolding the ladder to prevent injuries and pinching of fingers. Failure to comply may result in personal injury.

Apply pressure in opposite directions to ensure smooth operation of the ladder.

Hand Positions to Unfold the Ladder

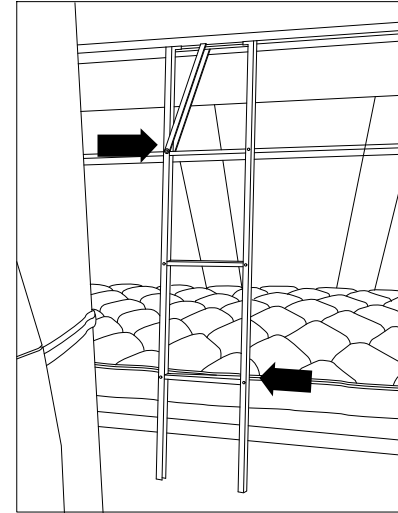

7. Make sure the ladder is completely unfolded against the internal stop. The ladder should be vertical at this point.

1



CAUTION

Do not attempt to open the lower bunk when the ladder is unfolded and vertical. Failure to comply may result in property damage.



CAUTION

Never attempt to pull the bottom of the ladder forward when the ladder is in the down position. Failure to comply may result in property damage.



CAUTION

Never attempt to fold or force the ladder toward the passenger side of the vehicle once the ladder has reached vertical position and is against the internal stop inside the upper bunk. Doing so can cause damage to the ladder.

How to Climb In and Out of the Upper Bunk



WARNING

Make sure the ladder is fully open before climbing up or down the ladder. The ladder should be against internal stops and vertical before using it. Failure to do so may result in death or personal injury.



WARNING

Never use the ladder while the vehicle is in motion. Always fold and stow the ladder before moving the vehicle. Failure to comply may result in death or personal injury.



WARNING

Do not exceed the weight limit of 320 lbs on the ladder. Failure to comply may result in death or personal injury.



WARNING

Never climb a damaged, bent, or broken ladder. Doing so may result in personal injury.



WARNING

Never allow multiple people on the ladder at the same time. Only one person on the ladder at any time. Failure to comply may result in personal injury.

Make sure the ladder is in the unfolded position.

1. Face the ladder when climbing up or down.

Face the ladder

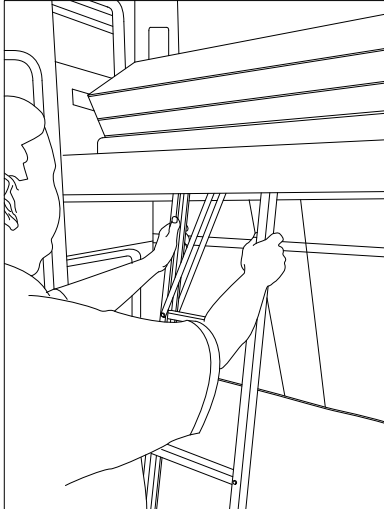

2. Maintain a firm grip when climbing up or down the ladder. Use the ladder and grab handles provided, and always keep at least three points of contact between your hands and feet and the truck.

Always face toward the bunk when entering or exiting the upper bunk and look where you are going.

3. As you get higher on the ladder, maintain contact with the sleeper upper grab handles as you get onto the upper bunk.

Upper Grab Handles

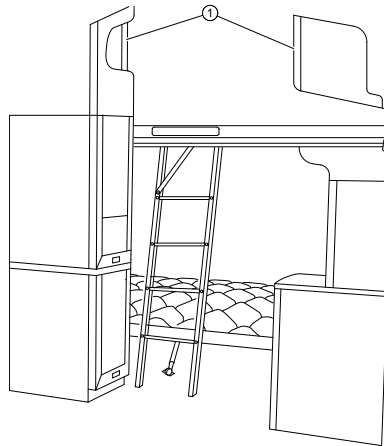

1. Upper Grab Handles

How to Fold the Upper Bunk Ladder

WARNING

Do not attempt to fold or unfold the ladder while an occupant is in the lower bunk. Allow the lower bunk occupant to vacate the bunk before folding or unfolding the ladder. Failure to do so may result in personal injury.

CAUTION

Lower bunk must be in down position before folding and unfolding the ladder. Failure to do so may result in property damage.

1. Ensure that the lower bunk is in the down position.
2. Position your left hand, open palm, against the lower left side of the ladder. Maintain contact with your left hand, open palm, in the same position until the ladder is completely folded.

1

3. Position your right hand, open palm, against the upper right side of the ladder. Maintain contact with your left hand, open palm, in the same position until the ladder is approximately half-way folded.

Hand Positions to Fold the Ladder



WARNING

Do not grip the ladder while folding and unfolding it. Always use an open hand when folding and unfolding the ladder to prevent injuries and pinching of fingers. Failure to comply may result in personal injury.



CAUTION

Lower bunk must be in down position before folding and unfolding the ladder. Always fold the ladder before raising the lower bunk. Failure to do so may result in property damage.

Apply pressure in opposite directions to ensure smooth operation of the ladder.



WARNING

Right hand must be clear of the ladder when it is approximately half-way folded. Failure to do so may result in personal injury.

4. Use the right hand to apply pressure to the left and

simultaneously use the left hand to apply pressure to the right. The ladder will begin to fold up.

5. When the ladder is approximately half-way folded, remove your right hand from the right side of the ladder.
6. Continue to push with your left hand until the ladder has been folded into the upper bunk structure.
7. Secure the latch.



CAUTION

Make sure the ladder is fully closed while the vehicle is in motion. Failure to do so may result in property damage.

Deckplate Access

Guidelines for getting onto the deckplate

WARNING

Always reinstall steps before entering the cab or accessing the deck plate. Without steps you could slip and fall. Failure to comply may result in personal injury or death.

WARNING

Keep steps clean. Clean any fuel, oil, or grease off the steps before entering the cab or accessing the deck plate. Stepping on a slippery surface can cause a fall which may result in death or personal injury.

WARNING

When you are climbing onto and off the deck plate, maintain at least three points of contact with your hands on

the grab handles and your feet on the steps. Always face toward the vehicle when entering or exiting the cab and look where you are going. Failure to comply may result in death or personal injury.

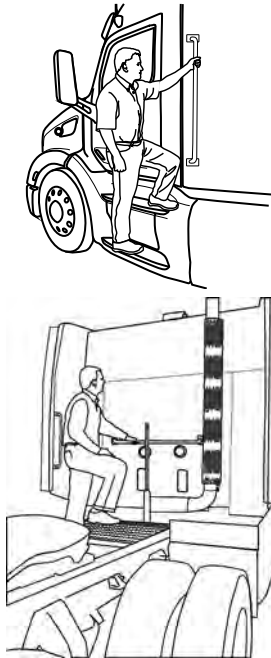

1

**WARNING**

When stepping onto a surface to enter the cab or access the deck plate, only use the steps and grab handles installed and designed for that purpose. Failure to use the proper steps and grabhandles could cause a fall which may result in death or personal injury.

**NOTE**

Any alteration (adding bulkheads, headache racks, tool boxes, etc.) behind the cab that affects the utilization of installed grab handles, deck plates, or frame access steps should comply with Federal Motor Carrier Safety Regulation 399.

Access the engine by opening the hood. The hood is typically held in the closed position by a latch system. The latch typically is mounted on the hood and the mating side is on the cab or quarter fenders

**WARNING**

Before opening or closing the hood, make sure your footing is secure and stable. Failure to do so may cause the hood to close uncontrollably which may result in death or personal injury.

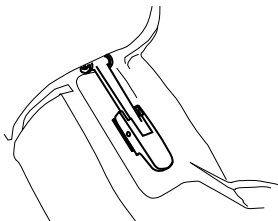
**CAUTION**

A hood not latched securely could open during operation and cause vehicle damage. Be sure to latch the hood securely.

**WARNING**

A pivoting hood could hurt someone or be damaged itself. Before opening or closing the hood, be sure there are no people or objects in the way. Failure to stand in a position of safety can cause death or personal injury.

1. Release the latches

How to open the hood

How to open a hood to gain access to the engine.

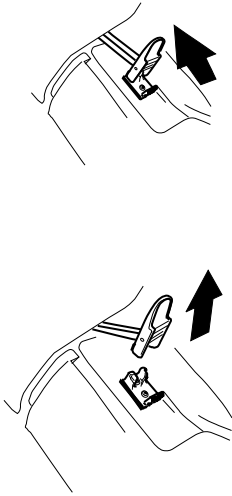

- Put one or both hands on the top of the hood front. Tilt the hood forward by pulling at the top of the hood keeping your feet on the ground for stability. Keep pulling on the hood until you are certain that the hood hold open device is engaged.



Close the Hood

The hood is equipped with a hood hold-open device. In order for the hood hold-open device to become engaged, the vehicle hood must be fully open. Once the vehicle hood is fully open, the hold-open latch will automatically engage and will need to be disengaged by the operator.

The release lever for the hood hold-open device is located near the front hinge of the hood.

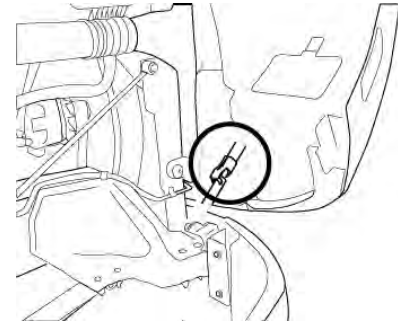

Pull the lever out to disengage the hood hold-open device.

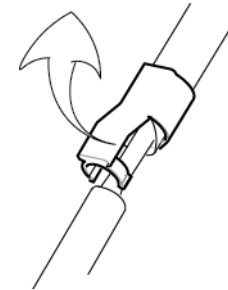

When closing the hood, be sure that you maintain the same point of contact (top of hood) to control the movement of the hood as it closes. Gently lower the hood into place to avoid damage to the hood or cab.

**WARNING**

Do not let go of the hood while it closes. Close the hood in a controlled manner which requires hands firmly grasping the hood and feet on a stable, non-slip, surface. Failure to control the hood as it closes may result in death or personal injury.

**WARNING**

Always ensure the hood hold open latch is engaged to keep the hood fully open any time anyone gets under the hood for any reason. Failure to do so may cause the hood to close uncontrollably which may result in death or personal injury.

**WARNING**

Before closing the hood, be sure the area is clear—no people or objects are in the way. Failure to do so may result in death or personal injury.

What is the under hood air intake?

The option for under hood intake is a switch on the dash that allows the operator to use air from under the hood in the event the air cleaner opening is blocked by snow or ice.

**WARNING**

Do not open the under hood air door with hands. This door is held closed with a spring which may pull the door closed unexpectedly. Failure to comply may result in personal injury.

**CAUTION**

Only operate the under hood intake air switch when outside temperatures are below 32° F (0° C). Engaging the under hood air intake while temperatures are above freezing may result in engine damage.

The switch is directly wired to a solenoid on the air cleaner. This air solenoid (normally closed) will engage when signaled which will supply air to a piston. This air pressure will overcome a spring

which holds a door closed inside the air cleaner. Fully engaged, the door will open and an air will enter from under the hood instead of the opening on the side of the hood.

Related concepts**Seat**

For further information on features and adjustment of the seat, see the manufacturer's Service and Operation Manual included with the vehicle.

This seat has up to 10 different controls that maximize the driver's comfort. Lumbar (and bolster support if available) are provided for superior support to the back during operation. Lower support is standard and the optional functions include upper lumbar and bolster functions. Pressing on the "+" symbol of the button will add support in the area. Pressing the opposite side of the button will release pressure and will reduce support in the area.



The seats in this vehicle are equipped with a switch that locks out the fore-aft isolator function in the seat. When locked, the seat will not move back and forth. It will be rigidly fixed and only allowed to move up and down with the vehicle's movements. This vehicle may be equipped with a swivel function on the passenger seat. This function allows the passenger seat to rotate and face towards the inside of the cab.

**WARNING**

Always ensure that the passenger seat is locked into the forward facing position when the vehicle is in motion. Locking the swivel seat into the forward facing position maximizes visibility to the surrounding area. Failure to comply creates a safety hazard that may result in death or personal injury.

**WARNING**

Do not use the swivel function while a passenger is in the seat and the vehicle is in motion. The seat belt will not provide proper protection if the passenger is not facing forward and the vehicle is in an accident. Failure to comply may result in death or personal injury.

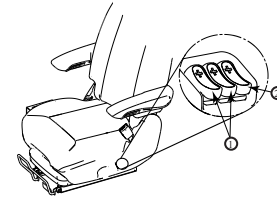

1. Lower and Upper Lumbar Adjustment
2. Bolster Adjustment (optional)

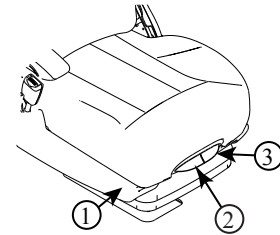

1. Seat heater/cooler
2. Seat thigh support up/down
3. Seat bottom angle adjustment

**WARNING**

Seat heaters should not be used if the operator or passenger has difficulty in sensing and reacting to an increased temperature of the seat. The heater function may result in personal injury.

**WARNING**

Do not use the seat heater for more than 10 minutes at one time. Always turn off the seat heaters when they are not needed. Overuse of the seat heater may decrease the capacity of the vehicle's batteries and may result in poor starting and potential equipment damage.

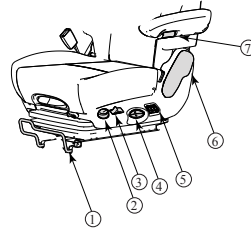

1. Seat fore/aft
2. Express down
3. Suspension stiffness
4. Seat height
5. Lumbar and Bolster (Bolster is an optional feature)
6. Recline
7. Armrest angle

**WARNING**

Do not drive or ride with your seat back in the reclined position. You could be injured by sliding under the seat belts in a collision. Failure to comply may result in personal injury or death.

Passenger Seat Swivel (Optional)

This vehicle may be equipped with a swivel function on the passenger seat. This function allows the passenger seat to rotate and face towards the inside of the cab.

**WARNING**

Always ensure that the passenger seat is locked into the forward facing position when the vehicle is in motion. Locking the swivel seat into the forward facing position maximizes visibility to the surrounding area. Failure to comply creates a safety hazard that may result in death or personal injury.

**WARNING**

Do not use the swivel function while a passenger is in the seat and the vehicle is in motion. The seat belt will not provide proper protection if the passenger is not facing forward and the vehicle is in an accident. Failure to comply may result in death or personal injury.

How to adjust a seat

This section covers the operation and safe use of your seats.



WARNING

Do not adjust the driver's seat while the vehicle is moving. The seat could move suddenly and unexpectedly and can cause the driver to lose control of the vehicle. Make all adjustments to the seat while the vehicle is stopped. After adjusting the seat and before driving off, always check to ensure that the seat is firmly latched in position. Failure to comply may result in personal injury, death, equipment or property damage.



WARNING

Before driving or riding in vehicle, ensure that there is adequate head clearance at maximum upward travel of seat. Injury may occur if head clearance is not adequate. Failure to comply may result in personal injury or death.

1. Set the seat's fore/aft position via the bar located below the seat cushion. This is a mechanical latch that does not involve any electric or air operated devices to control adjustment.
2. Set the seat height via the large switch on the left side of the seat cushion. This switch is located in the center of the seat pad and uses air to adjust the seat height.
3. Adjust the thigh support by toggling the switch located immediately under the seat bottom cushion and above the fore/aft position adjustment lever.
4. Adjust the seat bottom angle using the switch next to the thigh support.
5. Adjust the seat back recline angle using the large lever situated near the seat belt buckle.
6. Adjust the lumbar support by using the switch bank located on the side the seat cushion between the up/down adjustment switch and the seat recline adjustment lever.
7. Adjust the steering wheel. See how to adjust the steering wheel.
8. Adjust the cab side mirrors.

Safety Restraint Belts

Important safety information on how to use seat belts.

Safety belts have proven to be the single most effective means available for reducing the potential for either death or personal injury in motor vehicle accidents. The combination lap-shoulder belt is equipped with a locking mechanism. The system adjusts automatically to a person's size and movements as long as the pull on the belt is slow. Hard braking or a collision locks the belt. The belt will also lock when driving up or down a steep hill or in a sharp curve.

Unbelted riders could be thrown into the windshield or other parts of the cab or could be thrown out of the cab. They could strike another person. Injuries can be much worse when riders are unbelted. Always observe user warnings pertaining to safety belts. Your vehicle is equipped with a seat belt indicator lamp, located on the face of the tachometer.



WARNING

Do not drive vehicle without your seat belt and your passenger's belts fastened. Riding without a safety belt properly fastened can lead to injury or death in an emergency.



WARNING

Do not use the swivel function while a passenger is in the seat and the vehicle is in motion. The seat belt will not provide proper protection if the passenger is not facing forward and the vehicle is in an accident. Failure to comply may result in death or personal injury.

Correct Use of Restraint

Correct Placement of Lap Belt

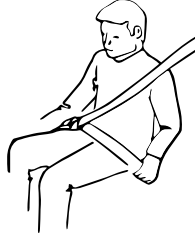

Correct Placement of Shoulder Belt



Incorrect Use of Restraint

Lap Belt Too High on the Hip



Should Belt Incorrectly Under the Arm



Safety Restraint Belt Twisted



During Pregnancy

Pregnant women should always wear combination lap/shoulder belts. The lap belt portion must be worn snugly and as low as possible across the pelvis. To avoid pressure on the abdomen, the belt must never pass over the waist. A properly worn seat belt may significantly reduce the risks to woman and baby in the event of a crash.



Safety Restraint Tips

- Do not wear a belt over rigid or breakable objects in or on your clothing, such as eye glasses, pens, keys, etc., as these may cause injury in an accident.
- Any authorized person sleeping in your vehicle while it is moving should use the bunk restraint.
- Any authorized person sitting in the sleeper area on the sofa bed (if equipped) while it is moving should wear a seat belt.
- A responsible operator sees to it that everyone in the vehicle rides or sleeps safely. The operator is responsible to inform any passengers or co-drivers how to properly use the seat belts and bunk restraint in the vehicle.
- Do not strap in more than one person with each belt.
- Keep seat belt and bunk restraint buckles free of any obstruction that may prevent secure locking.
- Damaged or worn belts in the cab or sleeper, subjected to excessive stretch forces from normal wear, must be replaced. They may not protect you if you have an accident.
- Any belts or restraints that have been subjected to an accident should be inspected for any loose (attaching) hardware or damaged buckles.
- If belts show damage to any part of assembly, such as webbing, bindings, buckles or retractors, they must be replaced.
- Do not allow safety belts (seat or bunk) to become damaged by getting caught in door, bunk or seat hardware, or rubbing against sharp objects.
- All belts must be kept clean or the retractors may not work properly.
- Never bleach or dye seat or bunk restraint belts: chemicals can

weaken them. Do, however, keep them clean by following the care label on the belts. Let them dry completely before allowing them to retract or be stowed away.

- Make sure the seat belts and bunk restraint of the unoccupied passenger seat or bunk is fully wound up on its retractor or is stowed, so that the belt or restraint tongue is in its properly stowed position. This reduces the possibility of the tongue becoming a striking object in case of a sudden stop.
- Do not modify or disassemble the seat belts or bunk restraint in your vehicle. They will not be available to keep you and your passengers safe.
- If any seat belt or bunk restraint is not working properly, see an authorized dealer for repair or replacement.

How to Use Lap/Shoulder Belt

Important safety information on using the seat belts.

Follow these steps to fasten your seat belt and be sure anyone riding with you does the same.



WARNING

Proper seat belt adjustment and use is important to maximize occupant safety. Failure to wear or adjust the safety belt properly may result in death or personal injury.

To fasten the belt:

1. Grasp the belt tongue.
2. Pull belt in a continuous slow motion across your chest and lap.
3. Insert belt tongue into buckle on inboard side of seat.
4. Push down until the tongue is securely locked with an audible click.
5. Pull belt to check for proper fastening and adjustment
 - a. Pull shoulder section to make sure belt fits snugly across the chest and pelvis.
 - b. There should be less than one inch (25 mm) gap between the body and the belt.

- c. The shoulder belt must be positioned over the shoulder, it must never rest against the neck or be worn under the arm.
- d. Make sure any slack is wound up on the retractor and that the belt is not twisted.

If the belt is locked, lean the body back to remove any tension in the belt. After releasing the belt, allow the belt to retract completely by guiding the belt tongue until the belt comes to a stop.

To unfasten the belt, push the release button on the buckle and the belt should

spring out of the buckle.

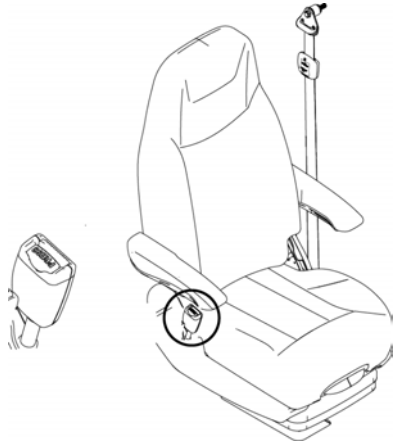

Tether Belts

This vehicle may have an external tether belt installed with a seat, instead of the internal tethering device. Tether belts are designed to restrain the seat in the event of a sudden stop or an accident. Internal tether belts do not require adjustment.

Make sure that the tether belt is attached to the cab floor and seat frame. It should be routed through the buckle on each side. Often the attachments are made using a

split-type hook. Make sure both halves of the hook are around the anchor bracket.

WARNING

Do not remove, modify, or replace the tether belt system with a different tether system. A failed or missing tether belt could allow the seat base to fully extend in the event of an accident. Failure to comply may result in death or personal injury.

WARNING

Failure to adjust external tether belts properly can cause excessive movement of the seat in an accident. Tether belts should be adjusted so that they are taut when the seat is in its most upward and forward position. Failure to comply may result in death or personal injury.

Adjust an external tether by either lengthening or shortening the strap. To lengthen it:

1. Turn the buckle to a right angle to the webbing.

2. Then pull the buckle.
To shorten the tether, pull on the strap.

Komfort-Latch® Feature

This device is designed to eliminate cinching and provide improved safety and comfort. Cinching is the condition where a belt becomes continually tighter around you during a rough, bouncy ride. The need for this feature increases with rough road conditions, particularly over long distances.

WARNING

Do not set the KomfortLatch® with too much slack. Too much slack may reduce the effectiveness of the seat belt. Failure to comply may result in death or personal injury.

To eliminate cinching, simply activate the Komfort-Latch® device located on the seat belt webbing at the appropriate time:

1. Adjust the seat to its proper driving position.
2. Latch the seat belt.
3. If available, adjust the seat belt height adjuster to a comfortable driving position.

4. While seated appropriately, push the "on" button to engage the Komfort-Latch.
5. Lean forward in the seat until you hear a "click."
6. Return to normal driving position, and the Komfort-Latch maintains the preset amount of tension relief.

More information and video tutorials can be found at: <http://www.clicktugsnug.com/>
To disengage the mechanism unbuckle the seat belt and then press the **OFF** button of the Komfort-Latch® or tug on the shoulder strap.

Belt Damage and Repair

Precautions for damaged or worn seat restraints.

Damaged belts in the cab must be replaced. Belts that have been stretched, cut, or worn out may not protect you in an accident.

If any seat belt is not working properly, see an Authorized Service Center for repair or replacement.

For further information on seat belts and seat belt maintenance, see [Safety Restraint System - Inspection](#) on page 221.

Sleeper Bunks and Restraints

For cabs equipped with a sleeper, be sure to use the restraint devices when the vehicle is in motion.

This vehicle comes equipped with a bunk restraint for the primary lower bunk and the optional upper bunk. These restraints should be used whenever the bunks are occupied by a person while the vehicle is in motion. The sleeper bunk restraint is intended to reduce the risk of being thrown from the bunk in a crash. This device is not designed to hold the occupant in a fixed position on the bunk and may not prevent all injuries in the event of a crash.

WARNING

Be sure the restraint system is used when anyone is occupying the sleeper while the vehicle is moving. In an accident, an unrestrained person lying in a sleeper bunk could be seriously injured. He or she could be thrown from the bunk. Failure to comply may result in death, personal injury, equipment or property damage.

Lower Bunk

WARNING

Always keep the lower bunk in its horizontal, latched, position while the vehicle is moving. If left open, stored items could become loose during an accident and strike you, causing death or personal injury.

Before you move the vehicle, check to be sure the lower bunk is in the down position.

Lower Bunk Sleep Restraints

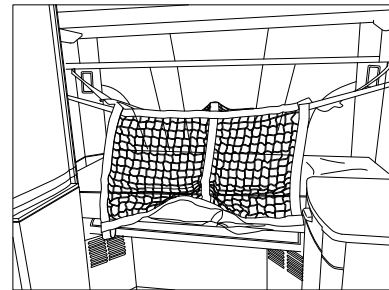

Upper Bunk



WARNING

Be sure the latch that holds the upper bunk in the folded position is working properly so the bunk will not fall down. Pull on the bunk to be sure it is latched securely. If the bunk falls, you could be injured. Failure to comply may result in death, personal injury, equipment or property damage.



WARNING

Any loose items on the upper or lower bunk should be moved to a secured place before driving the vehicle. Failure to comply may result in death, personal injury, equipment or property damage.

Per FMCSR 392.60 - Unauthorized Persons Not to be Transported. Federal law prohibits the transportation of persons in commercial vehicles unless they are specifically authorized in writing by the motor carrier. See the cited FMCSR for a complete description of the regulation and exemptions.

Y53-6047-2HEN (03/18)

Upper Bunk Sleep Restraints

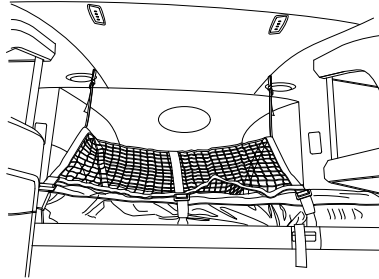

Upper Rear Sleeper Storage

Your vehicle may be equipped with an upper storage shelf that extends over the lower bunk and across the rear of the sleeper. The following warning applies:



WARNING

Overhead compartments are not intended for personnel use or for items exceeding their designed weight limits. Exceeding the weight limits may cause the shelf to collapse and/or items may fall out in a sudden stop which may lead to death or personal injury.

Compartments in the cab and sleeper are provided for storage of necessary items used during operation. The storage areas above the door are designed to hold a combined total not exceeding 14 lbs (6 kg) per compartment and the other overhead compartments (including those in the optional sleeper) should hold a combined total not exceeding 5 lbs (2.2 kg) per compartment.

What to do before starting the vehicle

Checks before you operate your vehicle.

Safe Vehicle Operation

Be sure to perform pre-trip inspections before starting and operating the vehicle. For your safety, as well as those around you, be a responsible driver:

- If you drink alcohol, do not drive.
- Do not drive if you are tired, ill, or under emotional stress.

Safe driving is only possible with the proper concentration on the driving task. Keep distraction to a minimum to improve your concentration. Examples of distractions may include radio controls, GPS navigation controls, cellular telephone

calls, cellular text messages, reading or reaching for something on the floor. Minimizing your distractions will improve safe driving and will help avoid an accident involving death or personal injury. Be aware of local regulations that may prohibit the use of cellular telephones while driving. In addition to being an unsafe practice, it may be against local or federal ordinances to use cellular devices while operating the vehicle. Much has gone into the manufacturing of your vehicle including advanced engineering techniques, rigid quality control, and demanding inspections. These manufacturing processes will be enhanced by you, the safe driver, who observes the following:

- Knows and understands how to operate the vehicle and all its controls
- Maintains the vehicle properly
- Uses driving skills wisely

This manual is not a training manual. It cannot tell you everything you need to know about driving your vehicle. For that you need a good training program or truck driving school. If you have not been trained, get the proper training before you drive. Only qualified drivers should drive this vehicle.

For more information, refer to Department of Transportation Regulation 392.7, which states that interstate commercial motor vehicles are not to be driven unless the driver is sure that certain parts and accessories are in working order. Do not drink alcohol and drive. Your reflexes, perceptions, and judgment can be affected by even a small amount of alcohol. You could have a serious or even fatal accident, if you drive after drinking. Please do not drink and drive or ride with a driver who has been drinking.

**WARNING**

The use of alcohol, drugs, and certain medications can impair perception, reactions, and driving ability. These circumstances can substantially increase the risk of an accident. Failure to comply may result in death, personal injury, equipment or property damage.

**WARNING**

Do not text and drive. Your reaction time, perceptions and judgment can be affected while texting or using any other

er form of mobile messaging while driving. Failure to comply may result in death, personal injury, equipment or property damage.

Emergency Equipment

It is good practice to carry an emergency equipment kit in your vehicle. One day, if you have a roadside emergency, you will be glad the following items are with you:

- window scraper
- snow brush
- container or bag of sand or salt
- emergency light
- warning triangles
- small shovel
- first aid kit
- fire extinguisher
- vehicle recovery hitches

Drivers Checklist

To keep your vehicle in top shape and maintain a high level of safety for you, your passengers, and your load, make a thorough inspection every day before you drive. You will save maintenance time later, and the safety checks could help prevent a serious accident. Please remember, too,

that Federal Motor Carrier Safety Regulation 392.7 requires a pre-trip inspection and so do commercial trucking companies.

You are not expected to become a professional mechanic. The purpose of your inspections is to find anything that might interfere with the safe and efficient transportation of yourself, any passengers, and your load. If you do find something wrong and cannot fix it yourself, have an authorized dealer or qualified mechanic repair your vehicle right away.

The following operations are to be performed by the driver. Performing these checks and following the maintenance procedures in this manual will help keep your vehicle running properly.

Vehicle Loading

Compare your vehicle's load capacity with the total load you are carrying. If adjustments need to be made, make them, do not drive an overloaded vehicle. If you are overloaded or your load has shifted, your vehicle may be unsafe to drive.



WARNING

Do not exceed the specified load rating. Overloading can result in loss of vehicle control, either by causing component failures or by affecting vehicle handling. Exceeding load ratings can also shorten the service life of the vehicle. Failure to comply may result in death or personal injury.



WARNING

An unevenly distributed load or excessive load over one axle can adversely affect the braking and handling of your vehicle, which could result in an accident. Even if your load is under the legal limits, be sure it is distributed evenly. Failure to comply may result in death, personal injury, equipment or property damage.

The Gross Vehicle Weight Rating (GVWR) or the maximum front and rear Gross Axle Weight Ratings are determined by the components installed from the factory on to the vehicle and their designed

specifications. (Axle weight ratings are listed on the driver's door edge.)

GVWR	is the Gross Vehicle Weight Rating. This is the MAXIMUM WEIGHT your vehicle is allowed to carry, including the weight of the empty vehicle, loading platform, occupants, fuel, and any load. Never exceed the GVWR of your vehicle.
GCW	is the actual combined weight, or Gross Combination Weight (GCW), of your vehicle and its load: vehicle, plus trailer(s), plus cargo.
GAWR	is the Gross Axle Weight Rating. This is the total weight that one axle is designed to transmit to the ground. You will find this number listed on the driver's door edge.
Load Distribution	be sure any load you carry is distributed so that no axle has to support more than its GAWR.

Be sure that the load on the vehicle is distributed evenly across each axle so that no axle has to support more than its rated GAWR. In total, the vehicle and its load should not exceed the GAWR for each axle and must not exceed the GCW

Visual inspection while approaching the vehicle

Guidelines for visually inspecting your vehicle.

While approaching the vehicle, inspect the general appearance of the vehicle and its surroundings for any signs of needed attention.

NOTE

If equipped with a three-piece roof fairing, **DO NOT DRIVE WITH ROOF FAIRING FOLDED DOWN**, since the marker lamps will not be effective in that position.

Perform these basic inspection steps before operating the vehicle.

1. Check the overall appearance and condition. Are windows, mirrors, and lights clean and unobstructed?
2. Check beneath the vehicle. Are there signs of fuel, oil, or water leaks?
3. Check for damaged, loose, or missing parts. Are there parts

showing signs of excessive wear or lack of lubrication? Have a qualified mechanic examine any questionable items and repair them without delay.

4. Check your load. Is it secured properly?

Daily Checks

A driver should perform these checks of the vehicle daily, as a minimum.

NOTE

These checks are in addition to, not in place of, Federal Motor Carrier Safety Regulations. These regulations may be purchased by writing to: Superintendent of Documents U.S. Government Printing Office Bookstore 710 North Capitol Street N.W. Washington, DC 20402 or [ContactCenter@gpo.gov](mailto>ContactCenter@gpo.gov).

Engine

- Engine Oil
- Engine Coolant
- Power Steering Fluid

- Engine Belt
- Fuel Filter (Water Separator) [Fuel System](#) on page 246
- Windshield Washer Fluid
- Battery Cables - check the condition of the battery and alternator cables for signs of chafing or rubbing. Make sure that all clamps (straps) holding the cables are present and in good working order.
- Hood Latch
- Brake Lines and Hoses
- Steering Components - (pitman arm, draglink, power steering hoses, etc.).
- Hydraulic Clutch Fluid

Chassis and Cab Exterior

- Lights - are any exterior lights cracked or damaged? Perform an exterior light test using the dash mounted switch next to the steering wheel. [What is the Exterior Lights Self Test](#) on page 111.

**NOTE**

On certain vehicles equipped with LED technology, taillamps may emit a faint glow when the door is open and the dome lamp is illuminated.

- Window and Mirrors - clean and adjusted?
- Tires, Wheels and hubs [Tires](#) on page 261 [Wheels](#) on page 264
- Suspension Components - check for loose or missing fasteners. Check damage to springs or other suspension parts such as cracks, gouges, distortions, bulges or chafing.
- Brake Lines and Hoses - check lines, linkages, chambers, parking and service brake operation.
- Air System - [What is the Air System?](#) on page 207
- Steps and Grab Handles
- Frame Mounted Tanks (Fuel, Diesel Exhaust Fluid, etc) - check underneath the vehicle for signs of fluid leaks. If any are found, correct before operating the vehicle. Is the tank fill cap secure? Are the tank

straps tight? Is the strap webbing in place?

- Trailer Connections - are they secure and the lines clear? If they are not being used, are they stored properly? Is the trailer spare wheel secure and inflated? Is the landing gear up and the handle secured?
- Fifth Wheel - Is the kingpin or the sliding fifth wheel locked?

Cab Interior

- Seat - adjust the seat for easy reach of controls and visibility.
- Seat Belts - fasten and adjust safety restraint belts (which may include restraints in the sleeper).
- Steering Column - adjust for easy reach and visibility.
- Mirrors - check and readjust mirrors if necessary.
- Lights - turn ignition key to the ON position and check for warning lights and buzzer. Check operation of turn signals and emergency lights.
- Instruments - check all instruments.
- Windshield - check operation of windshield wipers and washers.
- Horn - check operation of horn.

- Fuel - check fuel. Is there enough fuel?
- Diesel Exhaust Fluid - check level. Is there enough fluid?
- Air conditioning filters in the cab and/or Sleeper - check the condition of the sleeper air conditioning air filter. Keep the sleeper floor area behind the passenger front seat clear of debris and pet hair. The sleeper air conditioner draws air from this area and excessive dirt or pet hair may shorten the service life of the sleeper air conditioning air filter.

Weekly Checks

A driver should perform these checks of the vehicle weekly.



NOTE

These checks are in addition to, not in place of, Federal Motor Carrier Safety Regulations. These regulations may be purchased by writing to: Superintendent of Documents U.S. Government Printing Office Bookstore 710 North Capitol Street N.W. Washington, DC 20402 or ContactCenter@gpo.gov.

Engine

- Belts
- Hoses
- Clamps
- Radiator
- Air Cleaner
- Aftertreatments System Components
- Exhaust Pipes
- Engine Air Pre-cleaner (Optional) - For vocational vehicles with optional engine air pre-cleaner, check the purge valve at the bottom of the hood mounted engine air precleaner for any obstructions. Make sure the purge valve will open and close as needed to purge dirt and water from the engine intake air.
- Automatic Transmission Fluid (where applicable) - Check level, after the engine has warmed up to operating temperature.

Chassis and Cab Exterior

- Battery - check battery and terminals.
- Wheel Cap Nuts - are they all in place and torqued properly - tighten if necessary. [Wheels](#) on page 264
- Controls and Wiring - check for condition and adjustment
- Steering Components - check pitman arm, draglink, and power steering hoses, etc., for loose, broken, or missing parts.
- Cab Air Conditioner Fresh Air Filter - check for condition and cleanliness.

Chapter 2 | EMERGENCY

In this Chapter:

Roadside Assistance.....	41
Low Air Alarm	41
Stop Engine Lamp.....	41
Low Oil Pressure Lamp.....	42
Engine is Overheating.....	42
How to inspect and replace a fuse.....	44
Where are the Fuses Located?.....	46
How to Jump Start a Battery.....	46
How to Recover a Vehicle.....	48

Roadside Assistance

Call toll-free to talk to someone at the PACCAR Customer Center.



1-800-4Peterbilt (800-473-8372)

The Customer Call Center is open 24-7-365 days a year and staffed with trained personnel (English and other languages if necessary), free of charge, to provide total roadside assistance. Their custom mapping system can locate the nearest Authorized dealers and Independent Service Providers (ISPs) based on the vehicle's location. In addition, the customer center can dispatch services for jump and pull starts, tires, trailers, fines and permits, chains, towing, hazardous clean-up, out of fuel (roadside), mechanical repairs and preventive maintenance services. If they can't answer a specific question, they will direct you to a representative who can.

Y53-6047-2HEN (03/18)

Low Air Alarm

These are actions that the operator should perform if the low air alarm on the dashboard instrument cluster turns on.



If this alarm turns on while parked or driving, be sure to perform these tasks:



WARNING

If the air pressure falls below 60 psi (414 kPa) the spring brakes may stop the vehicle abruptly, which could cause an accident resulting in personal injury or death. Observe the red warning lamps on the gauges. If one comes on, do not continue to drive the vehicle until it has been properly repaired or serviced.

1. Slow down carefully.
2. Move a safe distance off the road and stop.

3. Place the transmission in neutral (park with automatic transmissions, if equipped) and set the parking brake.
4. Turn OFF the engine.
5. Turn ON the emergency flasher and use other warning devices to alert other motorists.

If the light and alarm do not turn off at startup, do not try to drive the vehicle until the problem is found and fixed.

Stop Engine Lamp



This warning lamp illuminates when the engine has a serious problem. This is an emergency and the vehicle should be safely stopped at the soonest opportunity.

**WARNING**

This should be considered an emergency. You should stop the vehicle as safely as possible and turn OFF the ignition. The vehicle must be serviced and the problem corrected before driving again. Failure to do so may cause severe engine or Diesel Particulate Filter damage, or cause an accident which may result in death or personal injury.

Low Oil Pressure Lamp

The low oil pressure warning lamp will illuminate when the engine oil pressure drops which can cause damage to the engine.

**CAUTION**

Continuing to operate your vehicle with insufficient oil pressure will cause serious engine damage. Failure to comply may result in equipment or property damage.

It is important to maintain oil pressure within acceptable limits. If oil pressure drops below the minimum psi (kPa) a Red Warning Lamp on the oil pressure gauge will illuminate and the Stop Engine Lamp will come ON.

1. Slow down carefully.
2. Move a safe distance off the road and stop.
3. Place the transmission in neutral (park with automatic transmissions, if equipped) and set the parking brake.
4. Turn OFF the engine.
5. Turn ON the emergency flasher and use other warning devices to alert other motorists.
6. Wait a few minutes to allow oil to drain into the engine oil pan, and then check the oil level.

7. Add oil if necessary. If the problem persists, contact an authorized dealer as soon as possible.

Engine is Overheating

The cooling system may overheat if the coolant level is below normal or if there is sudden loss of coolant. Follow these steps if the engine is overheating.

**CAUTION**

The cooling system may overheat if the engine coolant is at the minimum level. A sudden loss of coolant, caused by a split hose or broken hose clamp could also lead to an overheat condition. Always inspect to ensure hoses and clamps are not cracked, worn, or loose. Failure to comply may result in equipment or property damage.

**NOTE**

The system may also temporarily overheat during severe operating conditions such as:

- Climbing a hill on a hot day.
- Stopping after high-speed/ high-load driving.
- Debris blocking air flow through the cooling module (radiator).

If the engine coolant temperature warning lamp comes on and the audible alarm sounds showing an overheat condition, or if you have any other reason to suspect the engine may be overheating, **DO NOT TURN OFF THE ENGINE** unless a low water warning device indicates a loss of coolant. Follow these steps:

Follow these steps if the engine coolant temperature is rising, or the temperature is already above normal, and there are no other warning alarms displayed in the instrument cluster.

1. Reduce engine speed, or stop. When stopped, place the transmission in neutral (N) and set the parking brake. Keep the engine running. See the vehicle operator's

manual for instructions on transmission shifting and parking brake information.

**WARNING**

To reduce the chance of personal injury, vehicle damage and/or death from overheated engines, which can result in a fire, never leave the engine idling without an alert driver present. If the engine should overheat, as indicated by the engine coolant temperature light, immediate action is required to correct the condition. Continued unattended operation of the engine, even for a short time, may result in serious engine damage or a fire. Failure to comply may result in death, personal injury, equipment or property damage.

**WARNING**

Removing the fill cap on a hot engine can cause scalding coolant to spray out and burn you badly. If the engine has been in operation within the previous 30 minutes, be very careful in removing the fill cap. Protect face,

hands, and arms against escaping fluid and steam by covering the cap with a large, thick rag. **DO NOT** try to remove it until the surge tank cools down or if you see any steam or coolant escaping. In any situation, remove the cap very slowly and carefully. Be ready to back off if any steam or coolant begins to escape.

**NOTE**

Keep the engine running at idle speed unless a warning icon turns on and requires an engine to be shut off.

**CAUTION**

Prolonged periods of idling after the engine has reached operating temperatures can decrease engine temperature and could cause engine damage from inadequate lubrication. The normal torsional vibrations generated can also cause transmission wear. An idle shutdown feature, available on PAC-CAR engines, can be programmed to shut the engine down after a period of low idle operation with no driver activity. A flashing warning lamp will inform the driver of an impending shutdown. Failure to comply may result in equipment or property damage.

**CAUTION**

If the truck is equipped with power take off (PTO) equipment, the engine shutdown system can be deactivated when the PTO is operational; however, engine idle periods should not exceed five minutes whenever possible. Failure to comply may result in equipment or property damage.

2. Check to ensure the Oil Pressure Gauge reads normal.
3. Make sure the engine fan is turning by switching the Engine Fan Switch from AUTO to MAN (Manual).
4. Increase the engine speed to about one-half of full operating speed, or 1,100 to 1,200 rpm, maximum for 2 or 3 minutes.
5. Return the engine speed to normal idle. Monitor the engine temperature. After the temperature returns to normal, allow the engine to idle 3 to 5 minutes before shutting it off. This allows the engine to cool gradually and uniformly.
6. If overheating came from severe operating conditions, the temperature should have cooled by this time. If it has not, stop the engine and let it cool before checking to see if the coolant is low.
7. Be sure the vehicle is parked on level ground or the readings may be incorrect. Check the coolant level at the cooling module surge tank.

Check the coolant level after each trip when the engine has cooled. The coolant level should be visible within the surge tank —add coolant if necessary.

How to inspect and replace a fuse

Use these steps to find blown electrical fuses or polyswitches.

Turn the ignition off and turn all lights off. Locate the fuses in either the cab, sleeper or main power fuse box.

All the electrical circuits have fuses to protect them from a short circuit or overload. If something electrical on your chassis stops working, the first thing you should check for is a blown fuse.

**WARNING**

Do not replace a fuse with a fuse of a higher rating. Doing so may damage the electrical system and cause a fire. Failure to comply may result in death, personal injury, equipment or property damage.

CAUTION

Never patch fuses with tin foil or wire. This may cause serious damage elsewhere in the electrical circuit, and it may cause a fire.

CAUTION

If a circuit keeps blowing fuses, have the electrical system inspected for a short circuit or overload by an authorized dealer as soon as possible. Failure to do so could cause serious damage to the electrical system and/or vehicle.

CAUTION

Before replacing a fuse, turn OFF all lights and accessories and remove the ignition key to avoid damaging the electrical system.

1. Turn OFF all lights and accessories and remove the ignition key to

avoid damaging the electrical system.

2. Determine from the chart on the fuse panel which fuse controls that component.
 - If the circuit has a fuse, remove that fuse and see if it is blown.
 - If the circuit has a polyswitch, have your electrical system inspected by an authorized dealer.

Fuse Puller

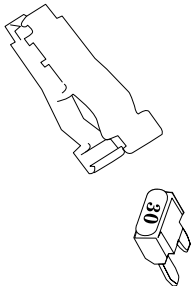

If it is blown, replace it with a fuse of the same rating. If a fuse of the same rating is

not available, a fuse of a lower rating may be temporarily substituted. You can also use a fuse from a circuit you can do temporarily without (for example an accessory circuit or radio).

CAUTION

When replacing a failed polyswitch (circuit breaker), always use an approved polyswitch (circuit breaker) with a current rating equal to or less than the polyswitch (circuit breaker) being replaced. Only use the approved Type II modified reset polyswitch (circuit breaker). NEVER use a Type I (automatic reset) or Type III (manual reset) polyswitch (circuit breaker). A fuse with a current rating equal to or less than the polyswitch (circuit breaker) being replaced can also be used.



CAUTION

Always close and latch the engine compartment fuse box cover. A latched cover ensures a water tight seal which can prevent damage to electrical components.

2

Where are the Fuses Located?

When determining if a fuse is blown, it is important to know where to find the related fuses.

Fuses for the cab are located in the fuse panel behind the drivers side kick panel. Main power relays are located on the power distribution center, in the engine compartment, mounted to the front wall of the cab.

Fuses for the optional sleeper are located on a separate fuse box accessible through the luggage compartment door.

How to Jump Start a Battery

Jump starting a vehicle is not a recommended practice due to the various battery installations and electrical options. However, if the vehicle battery is discharged (dead), the vehicle may start by using energy from a good battery in another vehicle. This is termed jump starting.



WARNING

Batteries contain acid that can burn and gasses that can explode. Ignoring safety procedures may result in death, personal injury, equipment or property damage.



WARNING

Never remove or tamper with battery caps. Ignoring this could allow battery acid to contact eyes, skin, fabrics, or painted surfaces. Failure to comply

may result in death, personal injury, equipment or property damage.



WARNING

Never jump start a battery near fire, flames, or electrical sparks. Batteries generate explosive gases that could explode. Keep sparks, flame, and lighted cigarettes away from batteries. Failure to comply may result in death, personal injury, equipment or property damage.



WARNING

When jump starting using a battery booster, it is best to jump start with an equivalently powered vehicle. Verify that the booster battery has the same volt and cold cranking amperage specifications as the dead battery before attempting to jump start. Failure to comply may cause an explosion resulting in death, personal injury, equipment or property damage.

**CAUTION**

Applying a higher voltage booster battery will cause expensive damage to sensitive electronic components, such as relays, and the radio. Failure to comply may result in equipment damage.

**CAUTION**

Improper hook-up of jumper cables or not following these procedures can damage the alternator or cause serious damage to both vehicles.

**WARNING**

Heed all warnings and instructions of the jumper cable manufacturer. Failure to comply may result in death, personal injury, equipment or property damage.

Be careful that metal tools (or any metal in contact with the positive terminal) do not contact the positive battery terminal and

any other metal on the vehicle at the same time. Remove metal jewelry and avoid leaning over the battery.

1. Remove any personal jewelry that may come in contact with the battery terminals.
2. Select a jumper cable that is long enough to attach to both vehicles in a way that ensures neither vehicle touches each other.
3. Position the two vehicles together, but do not allow them to touch.
4. Turn OFF all lights, heater, radio, and any other accessory on both vehicles.
5. Set the parking brakes: pull out the Yellow button located on the dash. See [Air Brake System](#) on page 146.
6. Shift the transmission into park position or neutral for manual transmissions. See [Operating Manual Transmissions](#) on page 141 and see [Automatic and Automated Transmissions](#) on page 143.
7. If either vehicle is equipped with battery disconnects ensure they are in the OFF position prior to connecting the two vehicles.

8. Attach one end of a jumper cable to the positive (+) terminal of the discharged (dead) battery. This will have a large red + or P on the battery case, post, or clamp.

**NOTE**

Always connect positive (+) to positive (+) and negative (-) to negative (-).

9. Attach the other end of the same cable to the positive (+) terminal of the good (booster) battery.
10. Attach the remaining jumper cable FIRST to the negative (-) terminal (black or N) of the good battery.
11. Attach the other end of the negative cable to the negative (-) terminal (black or N) of the dead battery.
12. If either vehicle is equipped with battery disconnects, ensure that they are in the ON position.
13. Start the vehicle that has the good battery first. Let it run for 5 minutes.
14. Start the vehicle that has the discharged (dead) battery.

The engine should start. If the engine fails to start, do not continue to crank the

starter. Instead, contact the nearest authorized dealer.

 **WARNING**

When disconnecting jumper cables, make sure they do not get caught in any moving parts in the engine compartment. Failure to comply may result in death, personal injury, equipment or property damage.

Reverse the above procedure exactly when removing the jumper cables. With engine running, disconnect jumper cables from both vehicles in the exact reverse order, making sure to first remove the negative cable from the vehicle with the discharged battery.

How to Recover a Vehicle

Follow these steps to properly recover a vehicle from a situation where the vehicle is unable to move on its own.

 **CAUTION**

Remove the drive axle shafts or lift the driving wheels off the ground before towing the vehicle. Towing the vehicle with either the wheels on the ground or the axle shafts in the axles will cause damage to the axle gears.

 **CAUTION**

If your vehicle has a Meritor axle with a driver-controlled main differential lock, install the caging bolt before removing the axles for towing, see Driver Controlled Main Differential Lock. Installing the caging bolt prevents damage by locking internal axle components in position.

 **CAUTION**

Connect recovery rigging only to hitches intended for that purpose. Do not attach to bumpers or brackets. Use only equipment designed for this pur-

pose. Failure to comply may result in equipment damage.

 **WARNING**

Before towing a vehicle, test your air brakes to ensure that you have properly connected and inspected the recovery vehicle's brake system. Failure to do so could lead to a loss of vehicle control which may result in an accident involving death or personal injury.

Your vehicle is equipped with removable Recovery Hitches, designed for short distance recovery purposes only. Use only the provided hitches, according the following instructions. When using this connection, do not transport your vehicle over long distances. (If your vehicle does not have the proper hitches, contact your dealer.)

All lubricating and clutch application oil pressure is provided by an engine-driven pump, which will not work when the engine is stopped. You could seriously damage your vehicle by towing it with the driveline connected and the drive wheels on the ground. Worse, when vehicles are towed, either by wrecker or piggyback, the

lubricant in the top front of the drive axle will drain to the rear. This will leave the top components dry. The resulting friction may damage them. Always remove the main drive axle shafts before towing your vehicle.

1. Review and understand all the cautions and warnings of this section.
2. Install the recovery hitch. See *What is a Recovery Hitch?* on page 51 and *How to use a Recovery Hitch* on page 52.
3. Disconnect the drive axle shafts and cover the open hubs. This is necessary because if the transmission is driven by the driveshaft (rear wheels on the ground), no lubricant will reach the gears and bearings, causing damage to the transmission. See *How to Prepare the Axles for Towing* on page 53.
4. Install the recovery rigging using a safety chain system, See *What are the Best Practices for Recovery Rigging?* on page 55.
5. Make sure the recovered vehicle's parking brakes are released. See

Manually Release the Parking Brake on page 49.

6. If you desire to use the recovered vehicle's brakes, ensure that the vehicle's air system is connected to that of the recovery vehicle. Ensure that any air line that has been removed from a driver-controlled main differential lock is firmly capped to prevent loss of air pressure from the recovery vehicle if it is supplying air pressure. If you don't desire to use the recovered vehicle's brakes, ensure that you cage the spring brakes before attempting to move the vehicle, see *How to Manually Lock a Differential* on page 54.
7. Follow state/provincial and local laws that apply to vehicles in tow.
8. Do not tow vehicles at speeds in excess of 55 mph (90 km/h).

For additional information concerning heavy duty truck recovery, refer to the following Technology & Maintenance Council (TMC) literature.

- Recommended Practice #602–A — “Front Towing Devices For Trucks and Tractors.”

- Recommended Practice #602–B — “Recovery Attachment Points For Trucks, Tractors, and Combination Vehicles
- Recommended Practice #626 — “Heavy Duty Truck Towing Procedures.”

Copies of these can be obtained from the following address: Technology & Maintenance Council 950 N. Glebe Road (703) 838-1763 Arlington, VA 22203 Email: tmc@trucking.org Website: <http://tmc.truckline.com>

Manually Release the Parking Brake

Recovering a vehicle may require the parking brakes to be released. There may be times when there is not enough air pressure, or the engine's air compressor is not able to produce enough pressure, to release the parking brakes. In such cases,

the parking brakes (or Spring Brakes) can be manually released.

! WARNING

Do not drive vehicle with malfunctioning brakes. If one of the brake circuits should become inoperative, braking distances will increase substantially and handling characteristics while braking will be affected. You could lose control of your vehicle or cause an accident. Have it towed to the nearest dealer or qualified repair facility for repair. Failure to comply may result in death, personal injury, equipment or property damage.

! WARNING

Do not operate a vehicle when the spring brakes have been manually released. Driving a vehicle after its spring brakes are manually released is extremely dangerous. The brakes may not function. Failure to comply may result in death, personal injury, equipment or property damage.

! WARNING

Do not disassemble a spring brake chamber. These chambers contain a powerful spring that is compressed. Sudden release of this spring may result in death or personal injury.

! WARNING

Releasing the spring brakes on an unsecured vehicle could lead to an accident. The vehicle could roll, which may result in death, personal injury, equipment or property damage. Always secure the vehicle with wheel chocks, chains, or other safe means to prevent rolling before manually releasing the spring brakes.

To move a vehicle immobilized by the spring brakes due to loss of air pressure in the brake system, perform the following procedure:

1. Remove the cap from the spring chamber

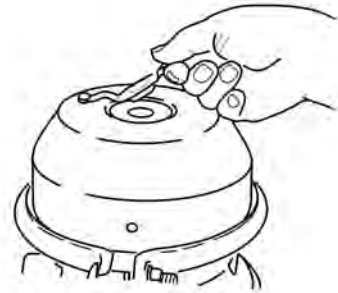

2. Remove the release stud assembly from the side pocket, and remove the release nut and washer from the release stud.

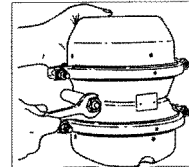

3. Slide out the release stud.

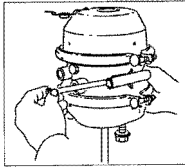

4. Insert the release stud through the opening in the spring chamber where the cap was removed. Insert it into the pressure plate. Turn the release stud 1/4 turn clockwise in the pressure plate. This secures the cross pin into the cross pin area of the pressure plate and locks it into the manual release position.

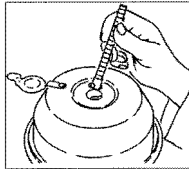

5. Assemble the release stud washer and nut on the release stud.

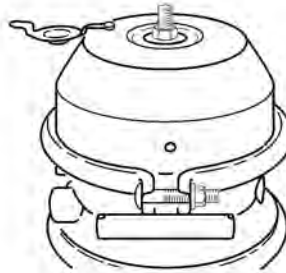

6. With a wrench, turn the release stud assembly nut until the compression spring is 90-95 percent caged. While doing this, check to make sure the push rod (adapter push rod or service push rod) is retracting. Do not over-torque the release stud assembly. (S-Cam type maximum: 50 lb-ft, Wedge type maximum: 30 lb-ft). The spring brake is now mechanically released.

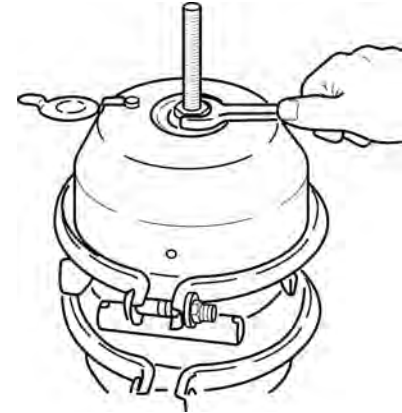

What is a Recovery Hitch?

A removable recovery hitch is a device that attaches to the sockets in the front bumper in the event the vehicle needs to be recovered. These hitches are designed for short distance and intermittent duty to help pull a vehicle. These hitches are not designed to be used as towing devices for long distance.

Specially designed hitches are required to recover your vehicle. The recovery hitches attach to the frame. Two hitch assemblies, made up of the following parts, are

recommended for the proper recovery of your vehicle:

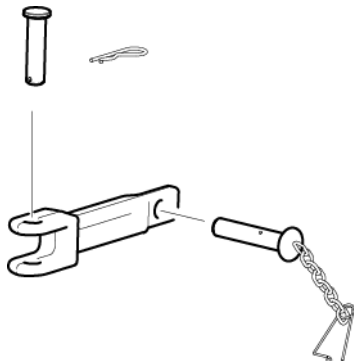

If your vehicle is not equipped with the proper recovery hitch assembly, contact an authorized dealer to obtain the proper equipment.



WARNING

Do not use parts from other trucks or materials from other sources to repair a hitch or to replace a missing hitch. The parts provided for recovery are made of high strength materials and are specifically designed for vehicle recovery. Failure to use the correct fac-

tory equipment may result in an accident involving death or personal injury.



CAUTION

Connect recovery rigging only to hitches intended for that purpose. Do not attach to bumpers or brackets. Use only equipment designed for this purpose. Failure to comply may result in equipment damage.

How to use a Recovery Hitch



CAUTION

Recovery pull maximums assume the tow rigging evenly distributes the load between both recovery hitches. See examples in Recovery Rigging for details. Serious damage to the vehicle may occur if rigging is not connected properly.



CAUTION

When recovering ditched or bogged vehicles, stay well below Maximum Capacities. Even at loads below maximum, the physical strain of recovering a vehicle could damage axles, suspensions, fifth wheels, etc.

Use the following procedure to install the Vehicle Recovery Hitches. See Recovery Hitch Assembly illustration for part identification.

1. Check square sockets behind lower bumper for obstructions, clear if necessary.
2. With lock pins removed, insert hitches through bumper and into the square hitch socket.
3. Align the hole in the tow hitch with the square hitch socket hole.
4. Insert the lock pin into the square hitch socket hole and through the hole in the tow hitch until the lock tab is within the square hitch socket.
5. Rotate the lock pin 90 degrees to secure the pin in place.

6. Ensure that the tow pin and lock clip are installed before using the hitch.
7. Remove the hitches and store all parts after recovering the vehicle.

How to Prepare the Axles for Towing

If the vehicle is going to be towed from the front axle and using the rear axle for support, then the axle shafts should be prepared [removed] so that minimal damage is made to the differential during the towing process.

Ensure that the recovered vehicle does not have an open air line. An open air line on the recovered vehicle will cause a leak in the air system of the recovery vehicle if both vehicles' brake systems are connected. This could cause a loss of system air, which can cause the service brakes not to function, resulting in the sudden application of the spring brakes causing wheel lock-up, loss of control, or overtake by following vehicles.



WARNING

An open air line on the recovered vehicle will cause a leak in the air system of the recovery vehicle if both vehicles' brake systems are connected. This could cause a loss of system air, which can cause the service brakes not to function, resulting in the sudden application of the spring brakes causing wheel lock-up, loss of control, or overtake by following vehicles. You could be in an accident involving death or personal injury. Ensure that any air line that has been removed from a driver-controlled main differential lock is firmly capped to prevent loss of air pressure from the recovery vehicle if it is supplying air pressure.

1. Lift driving wheels off the ground or remove the driveline and axle shafts before towing the vehicle.



CAUTION

Failure to lift the driving wheels off the ground or remove the driveline and

axle shafts before towing the vehicle could seriously damage your vehicle. All lubricating and clutch application oil pressure is provided by an engine-driven pump, which does not work when the engine is stopped. When vehicles are towed either by wrecker or piggyback, lubricant in the top front of the drive axle will drain to the rear. This will leave the top components dry, resulting in friction that will seriously damage these components.

2. If the vehicle has driver controlled differential lock, then manually lock the differential.
3. Remove drive axle shafts.
4. Cover the open ends of the hubs to prevent dirt and debris from entering the axle.



CAUTION

Water, dirt and other material can enter an open hub or axle. This can contaminate the axle fluid and cause possible damage to components. Ensure that the hubs are covered with plastic whenever a drive axle shaft is removed.

How to Manually Lock a Differential

Always lock the differential when the axles are being removed to aid in re-installation. Follow these procedures if the vehicle has a driver controlled differential lock.

This procedure should be done before the axle shafts are removed.



CAUTION

Failure to install the caging bolt when towing vehicles with driver-control main differential lock can result in damage by failing to lock internal components in position.



WARNING

An open air line on the recovered vehicle will cause a leak in the air system of the recovery vehicle if both vehicles' brake systems are connected. This could cause a loss of system air, which can cause the service brakes not to function, resulting in the sudden application of the spring brakes causing wheel lock-up, loss of control, or overtake by following vehicles. You could

be in an accident involving death or personal injury. Ensure that any air line that has been removed from a driver-controlled main differential lock is firmly capped to prevent loss of air pressure from the recovery vehicle if it is supplying air pressure.



CAUTION

A recovered vehicle will have no operational brake system. Additionally, the rear axle spring brakes will probably be applied.

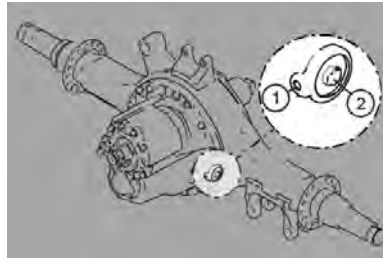

1. Caging bolt storage location
2. Location of air line to differential lock actuator

- If you desire to use the recovered vehicle's brakes, ensure that the vehicle's air system is connected to that of the recovery vehicle. Also ensure that any air line that has been removed from a driver-controlled main differential lock is firmly capped to prevent loss of air pressure from the recovery vehicle.
- If you don't desire to use the recovered vehicle's brakes, ensure that you cage the spring brakes before attempting to move the vehicle.
 1. Remove the air line and firmly cap the air line from the vehicle. (2)
 2. Remove the caging bolt from its storage hole. (1)
 3. Screw the caging bolt into the air line hole. (2)

When fully engaged, a 0.25 - 0.5 in. (6.35-12.7 mm) space will remain between the air cylinder and the bolt head. This action will lock the differential by pushing a piston into a "lock" position.

Recovery Hitch Capacities

The maximum rated loads for vehicle recovery varies depending on the direction or angle of pull. These capacities are listed

in the table below and are for the two hitches working together, simultaneously.

Direction of Pull	Maximum Capacity (lb)
Directly Forward	80,000 lb
Directly Vertical or Horizontally to the Side	14,600 lb
45 degrees in any Direction	20,000 lb

What are the Best Practices for Recovery Rigging?

Use these guidelines when recovering a vehicle with rigging and hitches.



CAUTION

Recovery pull maximums assume the tow rigging evenly distributes the load between both recovery hitches. See examples in Recovery Rigging for details. Serious damage to the vehicle

may occur if rigging is not connected properly.



CAUTION

When recovering ditched or bogged vehicles, stay well below Maximum Capacities. Even at loads below maximum, the physical strain of recovering a vehicle could damage axles, suspensions, fifth wheels, etc.

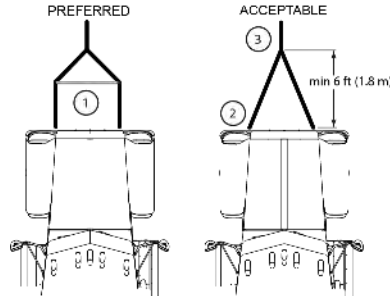

Use a double chain or cable setup that distributes the load equally to both hitches. See 1 or 2 in Recovery Rigging illustration. Never loop a single chain or cable through both hitches (3).

Use a spreader or equalizer bar to distribute the load on both hitches (1). If no spreader bar is available, connect the main tow chain or cable no closer than 6 ft. from the vehicle (2).

Returning to Service After Recovering

Once the vehicle is recovered, the axles need to have oil added to prevent gear damage during operation.

1. Into the pinion cage, add 1 pint (.47 liter) of lubricant or into the interaxle differential, add 2 pints (.94 liter) of approved lubricant.
2. After adding the specified type and amount of lubricant, drive the vehicle. It should be unloaded. Drive 1 to 2 miles (1.5 to 3 km) at a speed lower than 25 mph (40 km/h). This will thoroughly circulate the lubricant through the assembly.
3. If the parking brakes were manually released, they will need to be modified back to their normal operating condition.
4. If the differential lock was manually locked, then the caging bolt needs to be put back in its storage location and the differential lock air

line needs to be re-installed in its normal position.

Add lubricant back to the axles after recovering the vehicle and before putting it back in to service.

What to do if the Vehicle is Stuck in Sand, Mud, Snow or Ice



WARNING

Do not spin the wheels faster than 35 mph (55 km/h). Spinning a tire at speedometer readings faster than 35 mph (55 km/h) can be dangerous. Tires can explode from spinning too fast. Under some conditions, a tire may be spinning at a speed twice that shown on the speedometer. Any resulting tire explosion could cause injury or death to a bystander or passenger, as well as extensive vehicle damage: including tire, transmission and/or rear axle malfunction.

These suggestions are provided to improve the ability to free a vehicle if the vehicle gets stuck in sand, mud, snow, or ice:

- Move the gearshift lever or selector from First to Reverse.

- Apply light pressure on the accelerator pedal while the transmission is in gear.
- Remove your foot from the accelerator while shifting.
- Do not race the engine.
- For best traction and safety, avoid spinning the wheels.

Follow these practices to avoid transmission damage:

- Always start vehicle in motion with the shift lever in first gear.
- Be sure that transmission is fully engaged in gear before releasing the clutch pedal (manual only).
- Do not shift into reverse while the vehicle is moving.
- If the vehicle needs to be recovered from being stuck, do not permit the vehicle to be towed for long distances without removing the driveshaft.

If tire chains are needed, make sure they are installed on both sides of the driving axle. Installing chains on only one side of the axle can cause equipment damage.



CAUTION

Chains on the tires of only one tandem axle can damage the driveline U-joints and the interaxle differential. Repairs could be costly and time-consuming. Failure to comply may result in equipment damage.

Towing the Vehicle

Towing the vehicle should be done by either an authorized dealer or a commercial vehicle towing service. The dealer or commercial towing service will have the necessary equipment to safely tow the vehicle and should be able to make arrangements to limit any damage to the vehicle. The towing service and the dealer should be aware of towing regulations and safety precautions.

The towing service will ensure that the following precautions are taken:

- Use of a safety chain system.
- Abide by all local towing regulations.

- Ensure that the towing device does not contact any surfaces that could be damaged while in transit.
- If towing from the front, ensure that the rear axles are prepared for towing.
- If towing from the rear, ensure that all body components such as roof, side and chassis fairings are secured properly to avoid damage while in transit.

**WARNING**

Secure the roof, side and chassis fairings while towing from the rear. An unsecured fairing may come off of the vehicle during transit. Failure to secure the fairings while towing may cause an injury accident resulting in death or personal injury.

Chapter 3 | CONTROLS

3

In this Chapter:

Instrument Cluster.....	61
How to use the Menu Control Switch.....	65
Driver Information Display.....	66
Odometer/Trip Odometer	67
Outside Air Temperature.....	68
Clock.....	68
Active Warnings.....	68
Cruise Control.....	68
Header.....	69
Menu Control Switch Cue.....	69
Main Content Area.....	69
Blank Screen.....	69
Tire Pressure Monitoring System.....	69
Virtual Gauges.....	70

Ignition Timer.....	70
Fuel Economy.....	70
Trip Information.....	70
Truck Information.....	71
Warnings and Faults.....	72
Settings.....	73
Guide to the Warning Symbols.....	74
Optional Gauges.....	85
Dash Switches.....	89
Steering Column Controls.....	103
Controls on the Right Hand of the Steering Column.....	106
Controls on the Right Hand of the Steering Column.....	107
Steering Wheel Controls (Optional).....	107
City Horn.....	108
Door Mounted Controls.....	109
Ignition Key Switch.....	111
What is the Exterior Lights Self Test.....	111
How to use the Exterior Light Self Test Switch.....	112
Heating and Air Conditioning.....	112

Sleeper Alarm Clock..... 120
Cab Accessories..... 121
Sleeper Control Panel..... 126

3

Instrument Cluster

This section provides information regarding the dash and instrument cluster options and controls for the operator. For

information on using these features in driving, see the paragraphs that follow. Please remember that each vehicle is custom-made. Your instrument panel may not look exactly like the one in the pictures that follow. We have tried to describe the

most common features and controls available. You can pick out the parts that apply to you and read them to be fully informed on how your particular vehicle operates.

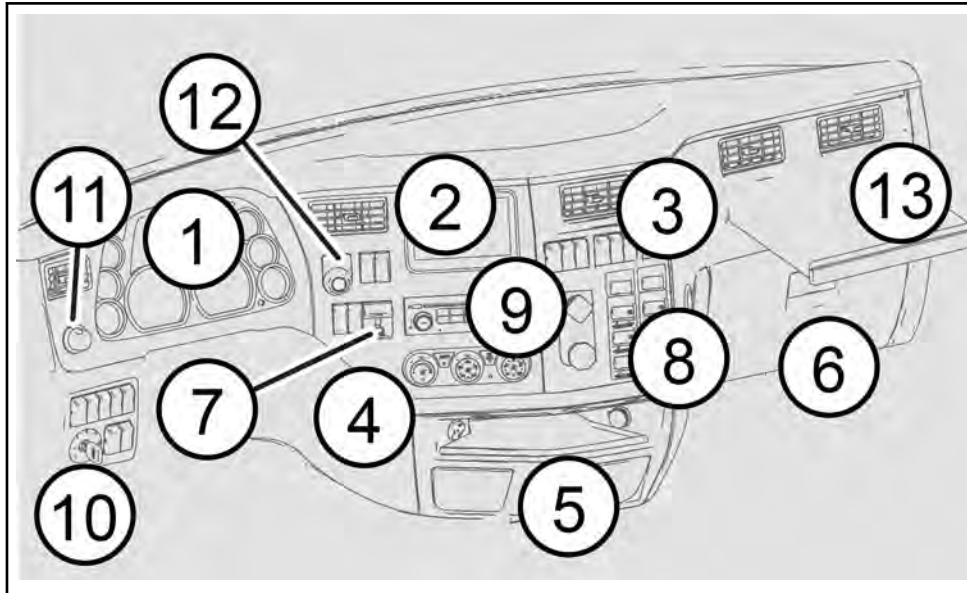

1. Instrument Cluster
2. Gauges (or optional navigation)
3. Switches
4. Air Conditioning
5. Cup Holder
6. Glovebox
7. Trailer Hand Brake
8. Tractor Park Brake
9. Radio
10. Ignition Switch
11. Headlight Switch
12. Menu Control Switch (MCS)
13. Passenger Side Pullout Tray

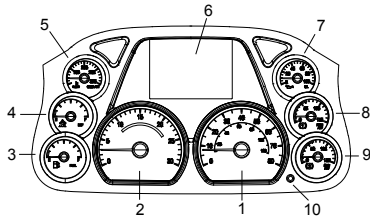

1. Speedometer
2. Tachometer
3. Fuel Level (Primary)
4. Diesel Exhaust Fluid (DEF)
5. Engine Coolant Temperature
6. Driver Information Display
7. Engine Oil Pressure
8. Primary Air Pressure
9. Secondary Air Pressure
10. Trip Reset Button

Instrument System Self Test

When the ignition switch is turned on the instrumentation system will undergo a Self Test. This test will verify the operation of the gauges and warnings. During the Instrumentation System Self Test, multiple warning icons will be displayed in a sequence. The total sequence should only take no more than 10 seconds to complete. Completing this sequence will indicate a

successful Self Test. Have your instrumentation system checked by a qualified service technician if does not successfully complete.

Audible Alarm

The audible alarm will sound during the Instrumentation System Self Test. The audible alarm will also sound in conjunction with most warning lights. These events include but are not limited to headlight on, fifth wheel, stop engine, primary/secondary air, and driver door open warnings.

Optional Icons

Additional icons may be operational depending on individual vehicle specifications. These will be included in the Instrument System Self Test.



NOTE

Some optional lights may illuminate even though your vehicle is not equipped with that particular feature.

Check Messages

Check messages are provided to give the operator additional information regarding systems that require attention due to a

system malfunction and/or operating conditions that may hinder safe and proper performance for the vehicle. Some messages can be managed by the operator while others may require an authorized dealer repair.

Speedometer

The Speedometer indicates the vehicle speed in miles per hour (mph) and in kilometers per hour (km/h). The Speedometer cluster also includes several warning and indicator lamps.

Tachometer

Engine speed information.

The Tachometer measures the engine speed in revolutions per minute (rpm). The rpm detail is also available as a viewable screen in the instrumentation cluster as a virtual gauge. The tachometer is a useful gauge when attempting to drive efficiently. It will let you match driving speed and gear selection to the operating range of your engine. If the engine speed gets too high, you can select a higher gear to lower the rpm's. If the engine speed drops too low, you can select a lower gear to raise the rpm's. To avoid engine

damage, do not let the pointer exceed maximum governed speed. (See your Engine Operation and Maintenance Manual for rpm recommendations.)

Optimal RPM Indicator

Information about the optimal fuel economy indicator.

The tachometer will illuminate a small green light just below the numbers of the gauge. This is to indicate the engine speed for optimal fuel economy.

Engine - Coolant Temperature

The water temperature gauge shows the temperature of the engine coolant.

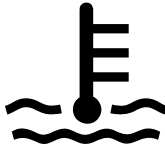

Under normal operating conditions the water temperature gauge should register between 165° and 205°F (74° and 90°C). Under certain conditions, somewhat higher temperatures may be acceptable. But the maximum allowable temperature is 210°F

(99°C), except for certain special engines. Check your engine manual to be sure.

Related tasks

Fuel Level

The Fuel gauge indicates the total (approximate) amount of fuel in the fuel tank.



In addition to indicating empty and full, the gauge(s) also indicate the fuel level in graduated increments. When the fuel level for the tank is below 1/4 full, a red warning light in the gauge will come on.



WARNING

Do not carry additional fuel containers in your vehicle. Fuel containers, either full or empty, may leak, explode, and cause or feed a fire. Do not carry extra fuel containers. Even empty ones are dangerous. Failure to comply may result in death or personal injury.



WARNING

Diesel fuel in the presence of an ignition source could cause an explosion. A mixture of gasoline or alcohol with diesel fuel increases this risk of explosion. Do not remove a fuel tank cap near an open flame. Use only the fuel and/or additives recommended for your engine. Failure to comply may result in death, personal injury, equipment or property damage.



CAUTION

Use only Ultra Low Sulfur Diesel (ULSD) Fuel, as recommended by engine manufacturers. If you need further information on fuel specifications, consult the Engine Operation and Maintenance Manual.



NOTE

For Export vehicles, the fuel gauges will not state: ULTRA LOW SULFUR DIESEL FUEL ONLY.



NOTE

This vehicle may be manufactured with different fuel systems and different draw tube locations. Because of this and the amount of road crown, it is recommended that you do not operate your vehicle with less than one-quarter of your truck's fuel capacity. Allowing the fuel level to go below one-quarter of capacity could result in the lack of fuel to keep the engine running. In addition, you will want to keep the fuel tanks at least half-full to reduce condensation of moisture in the tanks. This moisture can damage the engine.

Related tasks

Engine, Oil Pressure

If oil pressure drops below the minimum psi a red warning light in the gauge will turn

on, the Stop Engine light will come on and an audible alarm tone will sound.



CAUTION

Continuing to operate your vehicle with insufficient oil pressure will cause serious engine damage. Failure to comply may result in equipment or property damage.

It is important to maintain oil pressure within acceptable limits. For further information on engine oil and normal operating pressures, see the Engine Operation and Maintenance Manual. If the oil pressure fails to rise within 10 seconds after the engine starts, stop the engine and determine the cause. Check the engine manufacturer's manual for the correct oil pressure ranges for your vehicle's engine. If the oil pressure suddenly drops, or the audible alarm and engine oil pressure warning light come on while driving. For further information on engine gauges and operating your engine properly, refer to Engine Maintenance material.

Diesel Exhaust Fluid (DEF)

The diesel exhaust fluid gauge shows the approximate amount of DEF fluid in the DEF tank.



CAUTION

Use Diesel Exhaust Fluid only. Failure to do so may damage components of the Diesel Particulate Filter (DPF).

Besides empty and full, the gauge also indicates 1/4, 1/2, and 3/4 of total capacity. DEF fluid is required to meet certain emission requirements. Do not allow your DEF tank to remain empty. Please refer to your emission supplemental manual for more details about DEF fluid.

Vehicle Air Pressure

The Primary Air Pressure gauge indicates pressure in the rear braking system. The Secondary gauge indicates pressure in the front braking system.

Each gauge indicates the amount of air pressure in each system in pounds per square inch (psi). On vehicles equipped with metric air pressure gauges, the gauge

face plate includes a kPa (major) scale and psi (minor) scale.

**NOTE**

Be sure the air pressure registers more than 100 psi (690 kPa) in both service systems before you move the vehicle.

**NOTE**

If the pressure in either or both circuits falls below 65 psi (448 kPa), a red warning light in the gauge will turn on and an audible alarm tone will sound when the engine is running.

**WARNING**

If the air pressure falls below 60 psi (414 kPa) the spring brakes may stop the vehicle abruptly, which could cause an accident resulting in personal injury or death. Observe the red warning lamps on the gauges. If one comes on, do not continue to drive the

vehicle until it has been properly repaired or serviced.

**WARNING**

The air pressure warning light and the audible alarm tone indicate a dangerous situation: there is not enough air pressure in the air tanks for repeated braking and the brake system has failed. Without the use of your service brakes your spring brakes could suddenly apply causing a wheel lockup, loss of control, or overtake by following vehicles. This may cause an accident resulting in death or personal injury. Bring the vehicle to a safe stop right away, while you still have control of the vehicle.

Driver Information Display

The display can show multiple warning lights. Warning information will appear momentarily and then will minimize in the screen. Reviewing the warnings can be done by navigating the menu via the Menu Control Switch.

How to use the Menu Control Switch

The is used to navigate the instrument display. It comprises of a back button and a push and spin knob. The Menu Control Switch is located on the right side panel.

The knob can perform two functions. It can select and set values when spun and enter your settings when pushed. The button has a BACK button located above the knob. Pressing this button will go back to the previous menu.

1. Push on the center of the knob to select or enter a menu item

PUSH TO SELECT

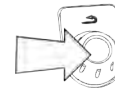

2. Spin the knob to navigate around the menu items



3. Push the back button should you need to return up to a menu item. If

the back button is held for 2 seconds the screen will turn off
 PUSH → TO GO BACK

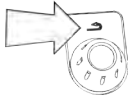

3

Driver Information Display

The Driver Information Display, located at the top of the instrument cluster.

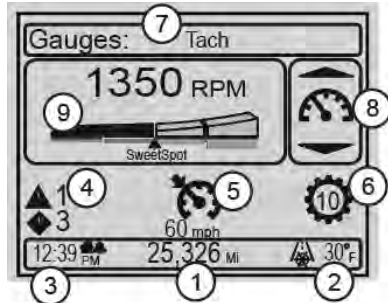

1. Odometer/Trip Odometer
2. Outside Air Temperature
3. Clock
4. Active Warnings

5. Cruise Control Indicator
6. Automated Transmission & Shift Indicator Area
7. Header
8. MCS Knob Cue
9. Main Content Window



WARNING

Do not look at the Instrument Cluster Display for prolonged periods while the vehicle is moving. Only glance at the monitor briefly while driving. Failure to do so can result in the driver not being attentive to the vehicle's road position or situation, which could lead to an accident and possible death, personal injury or equipment damage.

The display communicates important vehicle information through a constant monitoring of systems when any of the following conditions are met:

- Ignition key in ON or ACC positions
- Ignition timer is active
- The Menu Control Switch (MCS) button is pushed or spun (independent of ignition key switch position)

- Clock alarm sounds
- Driver or passenger door is opened
- Hazard warning lamp switch is ON
- Service brake switch is ON
- Tractor marker lamp switch is ON
- Trailer marker lamp switch is ON
- Low Voltage Display not active and the screen has not been put into "Display Off Mode"

In addition to a blank screen, the following are menu items and the information available within each menu selections.



NOTE

Some Driver Information Display functions are only accessible when the vehicle is parked. Other functions are accessible while the vehicle is moving or when parked. Each function is identified in the following descriptions.

Navigation of the system is organized into three levels of functions. The first level of organization is identified as "Trunk" level functions. The second level is identified as "Branch" level functions. The lowest level of functions are identified as the "Leaf" level functions. Some screens will appear

differently depending if the vehicle is moving or parked. The following images provide an example of a screen to get familiarized with the interface.

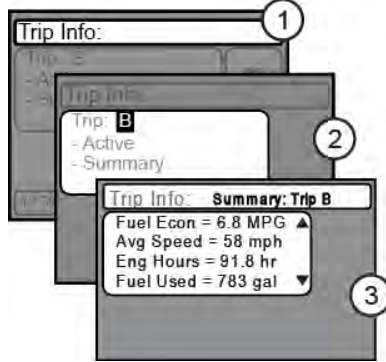

1. Trunk
2. Branch
3. Leaf

Trunk Level

At this level, you can navigate between functions by turning the The Menu Control Switch (MCS) function by pushing the knob; at which you would then be going to what is termed the “branch” level of the software.

Branch Level

In the branch level of functions, the The Menu Control Switch (MCS) knob rotation controls a cursor highlight. When something is highlighted, an The Menu Control Switch (MCS) push will select that item or toggle its contents. Toggle fields typically use a darker colored text to distinguish them from fields that take the user to the “Leaf level”.

Leaf Level

At this level, there are no more options to choose from. The The Menu Control Switch (MCS) can be used to scroll through various information and the back button can be used to revert up to the branch (one push) or the trunk (two pushes) levels of the system.

Odometer/Trip Odometer

The Odometer/Trip Meter comes on when the door is opened and when the ignition key is in the ACC or ON position. The odometer displays the distance your vehicle has traveled.

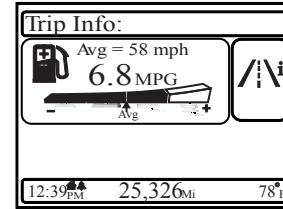

The display can be configured to display Metric units or English units. The current trip odometer displays how far the vehicle has gone on a particular trip and can display in increments of a tenth of a unit. The maximum distance that can be shown on the trip odometer is 9999.9 before it rolls over to zero. To reset the trip odometer, press and hold the button on the cluster. The numbers will reset to 0 and begin to count new miles/km traveled. Press the trip button on the instrument cluster any time you wish to view the odometer reading. Press the trip button again to scroll through the other odometers available in the cluster.

Outside Air Temperature

Used to display outside air temperature information and a warning of low temperatures.

The display will also alert the driver when the outside temperature approaches freezing (32° F or 0° C) by displaying a snowflake symbol. The symbol will turn on when the temperature drops below 34° F or 11° C and flash for the first 3 seconds, then stay on until the temperature goes above 37° F or 28° C. The systems unit of measure (Fahrenheit or Celsius) can be changed by navigating to the settings menu. The outside air temperature display will come on when the door is open and when the ignition key is in the ACC or ON position and turn off when the ignition switch is turned off. The outside air temperature display uses a sensor (located at the bottom of the driver's side mirror assembly) to measure outside air temperature only. It is not capable of displaying the temperature of the road surface on either the temperature display or the snowflake icon. Additionally, the outside air temperature reading may be affected by exposure to direct sunlight.

Clock

The clock presents either the home time or the local time when the clock is set.

If the clock is not set, the words "SET CLOCK" will appear when the ignition is turned ON. If the clock does not get set, the message will disappear and no time will be displayed. The time can be set while the "SET CLOCK" prompt is showing or it can be set by navigating to the settings menu via the Menu Control Switch. Set the Home time to the current time at the base of operation. Set the local time according to a time zone of destination. Reset the local time anytime the destination location changes and you need to use this function.

Related tasks

Active Warnings

Active warnings will appear in this area in addition to areas around the center of the display.

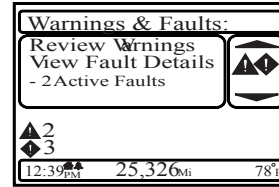

Active Warnings are those pop-up messages that have come up on the screen and/or been suppressed with a button push. If there are warning icons active while in the cruise control is enabled, icons will appear on each side of the cruise control icon. If there are multiple warnings, the display will show how many are active. The numbers may change without user interaction if individual warnings are intermittent, time based, self correcting, or the situation is rectified.

Cruise Control

This area is used to provide the driver with a dedicated location for cruise control set speed and if so equipped, adaptive cruise

control with its following distance information. Vehicles with adaptive cruise control will display many different icons in this area to alert the operator to take specific actions.



NOTE

If there are secondary telltales active while the cruise control is enabled, icons will appear on each side of the cruise control icon.

Header

This area displays the function category (at the trunk level) in which the knob and display software are currently set. Depending on the display operation, the text color may change to indicate a user selection.

Menu Control Switch Cue

Used to provide the driver with screen navigation feedback. Cues are provided

regarding when a user can push or spin the input control, shows in icon format which function is active, and which function will come up next if the knob is rotated either clockwise or counter clockwise.

Main Content Area

This area of the driver information display contains the dynamic information for the driver to see.

There are five functions allowed when driving, and seven when the vehicle is parked. Some functions are available in both modes, but have different content available dependent on the mode

Blank Screen

This screen is available in both parked and driving modes. The blank screen mode is to allow for minimized screen elements, while still maintaining some of the more permanent screen content such as the odometer, outside air temperature, warning cue, etc. This is different from the Display

OFF Mode where the entire display shuts off.

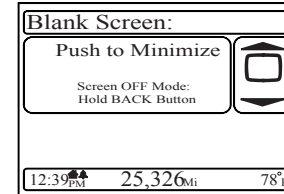

The blank screen mode is selected through the rotary knob. The Display OFF Mode is selected by pressing the button above the knob for more than 2 seconds.

Tire Pressure Monitoring System

The tire pressure monitor menu provides individual tire pressure and temperature information for each tire identified on the vehicle when the vehicle is parked only.

A push on the knob will open the menu item. Spinning the knob will scroll through

the tires and display the information accordingly. When scrolling through each tire's information, the relevant tire will appear highlighted in the menu screen. A warning message will appear if the system detects a tire temperature or pressure that is outside of normal parameters. This information is only available when parked

Virtual Gauges

The virtual gauges function is selected through the rotary knob and is available in both parked and driving modes.

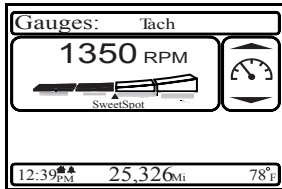

Virtual gauges provide dynamic information about the vehicle's performance. Spin the button to scroll through the available

gauges and push to select the desired gauge to view.

Ignition Timer

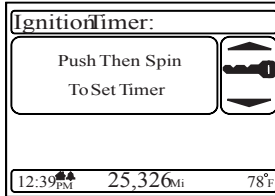

This function allows the driver to set a timer to shut off the truck. This feature is only available when the vehicle is parked. After the timer is set, the ignition key may be turned to the off position and removed. The engine will continue to run for the programmed time.

Fuel Economy

This function displays the dynamic fuel economy performance of the vehicle.

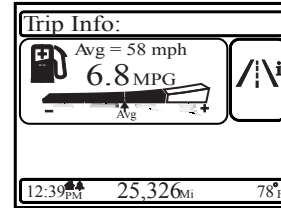

It shows Average Speed, Average Fuel Economy, and a dynamic instantaneous indication of fuel economy above or below the current average. The screen is available when driving. Average fuel economy is computed by the fuel consumed during the trip (see the next section for Trip information). The fuel economy for a trip will be reset when that trip odometer is reset.

Trip Information

This function allows you to keep trip information data on up to four separate trips – labeled A, B, C, and D. Trips are also selectable as "Active" or "Inactive" so you can use the data logging function to

treat trips separate from each other, or as segments of a combined trip.

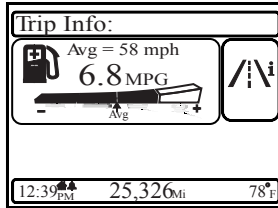

When driving, the screen only allows you to toggle which trip is viewed in the trip odometer and set the active/inactive status. When parked you can select and view a variety of data collected for each trip, as seen in the list below:

- Trip Economy
- Trip Average Speed
- Trip Engine Hours
- Trip Fuel Used
- Time in Cruise Control (%)
- Time in Sweetspot (%)
- Time in Overspeed (%)
- Trip Idle Hours
- Trip Idle Percentage (%)

- Trip Idle Fuel Used
- Trip Idle Percent Used (%)
- PTO Total Hours
- PTO Trip Hours
- PTO Trip Percentage (%)
- PTO Total Fuel Used
- PTO Trip Fuel Used
- PTO Trip Economy

The cluster mounted trip reset button is used to zero and clear accumulated trip data. Short presses toggle between the odometer view, and the four trips. Holding the button when on a particular trip will zero the stored data and also automatically set the cleared trip to “active” status. Using the knob while in this screen will only activate or deactivate a trip function.

NOTE

PTO options in the display will only be shown if the vehicle is equipped with a PTO.

Truck Information

This function displays the VIN specific information. This information is available when the vehicle is parked.

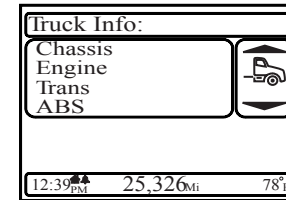

1. Chassis Information
 - Chassis Number
 - Fleet ID
 - CECU Software Version No.
2. Engine Information
 - Engine Make
 - Engine Model
 - Engine Software Version
 - Governed Speed Limit
 - Engine Power
3. Transmission Information

- Transmission Make
 - Transmission Model
 - Transmission Software Version No.
4. ABS Information
- ABS Make
 - ABS Model
 - ABS Software Version No.

Warnings and Faults

The display has a message alerting function that overrides the normal viewing and navigation of functions when an issue occurs on the truck.

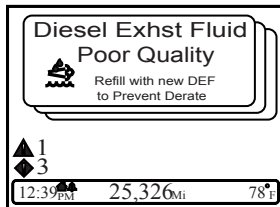

These alert messages are called “pop-ups” because they take over the screen. Some

messages are low enough priority that they can be “suppressed”, which is done by pushing the button. There will be a screen indicator showing which messages are suppressible. If multiple pop-ups are present at the same time, they are viewed in a stack format, and a spin of the knob will allow you to see the different warnings. The highest priority warning defaults to the top of the stack. When the vehicle is parked, the “Warnings and Faults” function will access suppressed pop-ups that are counted and presented in the upper left corner of the screen.

By selecting “Review Warnings” the pop-up messages are recalled, and if multiple are active, the stack can be navigated by spinning the knob. The warning description can be viewed when driving or when parked but the fault details are visible only when parked. The menu selection shown in the image above simply won’t be there if the truck is driving, though the warnings and tell-tale indicators on the cluster will still be available as indicators if the problem is serious. Fault details screens include:

1. How many faults, shown in a scrollable stack format
2. Which ECU the fault is being generated from

3. A text description of the issue
4. It’s actual fault code
5. Action instructions telling you what to do (i.e. seek service soon vs. correct at next scheduled service visit)

Diagnostic Messages

In addition to faults and warnings, the display will also create pop up messages for driver awareness. A list of some, not limited to, messages are described in the following list:

Service Advised	The Service Advised pop-up is a suppressible message accompanied by an audio “beep” that is displayed to warn the vehicle operator to seek service at a convenient time, to prevent any damage to the engine in the future.
Seek Service Immediately	This pop-up is accompanied by an audio “beep” and is displayed to warn the operator to seek service immediately in order to prevent damage to the engine.
Engine Derate In	This suppressible pop-up warning will display to warn the operator how much time remains before a Level 1 engine derate will occur. Once the popup is suppressed the popup will re-occur every 30 minutes to remind the operator of upcoming derate.

Level 1 Engine Derate The Level 1 Engine Derate is a suppressible pop-up and audio "beep" that is displayed when the ECU determines that engine power should be reduced to protect it from damage. A Level 1 Derate will reduce engine output by 25 percent.

Increased Derate This message is a suppressible pop-up that warns the operator how much time remains before a Level 2 engine derate will occur. Once the popup is suppressed the popup will re-occur every 15 minutes to remind the operator of upcoming derate.

Level 2 Engine Derate The Level 2 Engine Derate is a NON-suppressible pop-up and has a continuous audio tone, until the vehicle is parked. It is displayed when the ECU determines that engine power should be reduced to protect it from damage. A Level 2 Derate will reduce engine output by 40 percent.

Stop Engine Immediately The Stop Engine Immediately message, accompanied by a continuous, warning sound, is a NON-suppressible pop-up that is displayed to warn the operator to stop the engine immediately in order to prevent damage. The pop-up is suppressible only when the chassis is parked.

Settings

Various settings may be changed using this function. The operator can change the time format (12hr/24hr), the time of day and alarm settings, units of measure for the display (mile/kilometer), display mode and the language being displayed. This menu is available only when the vehicle is parked.

Changing settings functions are typically done one of two ways. Items can be toggled straight from the highlighted selection (at the branch level); these cases use dark blue text that changes to the set value. Others are menu selections that bring up new "leaf level" screens. The following shows examples of turning the alarm on/off vs. screens that are navigated to in order to set the clock time.

Display Mode

The operator can set the screen to be minimized through the settings menu. This minimized screen setting is different that the display off mode (which can be set at any time in menu navigation).

i

NOTE

There are times when the "Display Off" mode is not allowed or over-ridden by the system, for example if a "pop-up" message appears, the screen will turn back on, or if the truck is equipped with an adaptive cruise control system, the screen cannot be turned off when it is active.

Functions in the Settings Menu

Alarm	Set Turn alarm on or off
Clock	Display Home versus Local 12/24 hr format Units Set Home versus Local
Language	Set the display language
Dark Cabin (Optional)	Set interior lights to remain off when door is opened (ON)
Wipers On with Headlamps	Set the headlamps to automatically turn on with the wipers
Tailer Detection (Optional)	Set to On or Off

Low Voltage Disconnect (Optional)

Set voltage threshold for disconnect

Anti-Theft (Optional)

Enable/disable anti theft function

Driver Information Display Alarm On/Off

When in the Settings Menu,

1. Scroll through the list of menu items to "Alarm".
2. Press the to enter the alarm menu.
3. Press the to turn the alarm ON or OFF.

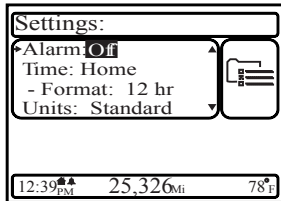

How to Set Clock Display Format

Use these steps to switch between 12 hr or 24 hr time display format.

When in the Settings Menu,

1. scroll through the list of menu items to "Format".
2. Press the to toggle between either 12 hour (AM/PM) or 24 hour (military) time.

How to set the Driver Information Display clock

These steps will help set the home, local or alarm time in the display

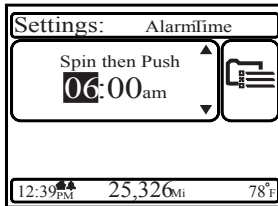

1. When in the Settings Menu, scroll through the list of menu items.

2. Press the to select the item to change.
3. Rotate the knob to change the hour. Press the .
4. Rotate the knob to change the minutes. Press the .
5. Rotate the to toggle AM/PM. Press the .
6. Press the button above the to Exit.

Anti Theft Menu

This menu selection allows the operator to turn the antitheft feature on or off. With the anti theft feature turned off, the operator will not need a passcode to start the engine.

The default passcode is set to 0000 at the factory. Please see an authorized dealer if a custom passcode is needed.

Guide to the Warning Symbols

Information and color of warning symbols.

The warning lights and audible alarm may indicate a system malfunction. Check the lights frequently, and respond properly as

soon as you see one go on. These lights could save you from a serious accident. When multiple warning icons are shown on the instrument cluster, they will appear at first and then minimize. When minimized they will be represented in the active warnings area of the display. A triangle represents a warning registered and a diamond represents a check message.

something is wrong with your vehicle. It could be a failure in an important system, such as the brakes, which could lead to an accident causing death or injury. Have the appropriate system checked immediately.

Check messages are provided to give the operator additional information regarding systems that require attention due to a system malfunction and/or operating conditions that may hinder safe and proper performance for the vehicle. The system will emit a chime to alert the operator that a

message is appearing on the cluster. Some messages can be managed by the operator while others may require an authorized dealer repair. In the following table is a list of Warning Light/Indicator Symbols that appear in the instrument cluster and Driver Performance Center. Each symbol has a unique name, appearance, color when illuminated, and whether the symbol is standard (Std) or optional (Opt).



WARNING

Do not ignore a warning light or audible alarm. These signals tell you

Symbol Name	Color	Standard or Optional
Axle, Traction Control	Yellow	STD
Axle, Stability Control	Yellow	STD
Brakes, Anit-Lock Brake System	Yellow	STD
Brakes, Low Air	Red	STD
Brake, Park Brake	Red	STD
Brake, Service Brakes	Red	OPT
Brakes, Trailer Anti-Lock Brake System	Yellow	STD
Differential, Inter Axle Lock	Yellow	OPT

Symbol Name	Color	Standard or Optional
Dump Truck, Body Up	Red	OPT
Dump Truck, Gate	Yellow	OPT
Dump Truck, Trailer Body Up	Red	OPT
Diesel Particulate Filter (DPF)	Yellow	STD
Emissions, High Exhaust System Temperature	Yellow	STD
Emissions, Malfunction Indicator Lamp	Yellow	STD
Engine, Check Engine	Yellow	STD
Engine, Engine Block Heater	Yellow	OPT
Engine, Engine Fan	Green	STD
Engine, Low Coolant Level	Yellow	STD
Engine, Overspeed Air Shutdown	Red	OPT
Engine, Retarder (Brake)	Green	OPT
Engine, Stop Engine	Red	STD
Engine, Wait To Start	Yellow	OPT
Fuel Water In Fuel (WIF)	Yellow	OPT
Lane Departure Warning (LDW)	Yellow	OPT
Lights, High Beam	Blue	STD

Symbol Name	Color	Standard or Optional
Power Take-off (PTO)	Yellow	OPT
Power Take-off (PTO) Pump Mode	Green	OPT
Refrigerator	Green	OPT
Seat Belt Fasten	Red	STD
Suspension Dump	Yellow	STD
Tire Inflation	Yellow	OPT
Transmission, Auxiliary	Yellow	OPT
Transmission, Check	Red	OPT
Transmission, Oil Temperature High	Yellow	OPT
Transmission, Retarder	Yellow	OPT
Transmission, Service Transmission (Allison only)	Yellow	OPT
Turn Signal, Left	Green	STD
Turn Signal, Right	Green	STD

Axle, Stability Control



Calculates the driver's intended path of travel from wheel speed and steering angle sensors, then compares calculations to the actual direction of travel. The system uses individual wheel brakes to re-adjust the path of the vehicle.

- The Stability Control Icon (ESC or Electronic Stability Control) illuminates during the power-on self test when the ignition is turned ON. It turns off after a few seconds if no system problems are detected. If a problem is detected, the ESC Warning lamp will turn on and stay on.
- Illuminates when the ESC system is regulating individual wheel brakes to correct the vehicle's direction of travel. (Refer to Advanced ABS with Stability Control for more information.)



WARNING

If this chassis is equipped with an electronic stability control (ESC) and is modified (e.g. adding or removing an axle, converting from a truck to a tractor, converting from a tractor to a truck, changing the body, lengthening of the wheelbase and/or frame, relocating frame components, or modifying pneumatic or electrical ABS/ESC harnesses) the ESC must be disabled by a qualified technician. If you have any questions, contact your authorized

dealer. Failure to comply may result in death, personal injury, equipment or property damage.



NOTE

For more information about the stability control system installed on your vehicle, please refer to additional material supplied with this operator manual, included in your glove box informational packet.

Axle, Traction Control



Monitors wheel speed for poor traction. If a wheel begins to slip due to poor traction, it may reduce engine power or apply brakes in an effort to regain traction.

- Illuminates during the power-on self-test when the ignition is turned ON. It turns off after a few seconds if no system problems are detected. If an ATC problem is

detected, the ATC warning lamp will turn on and stay on.

- Illuminates when the ATC is regulating wheel spin and turns off after the traction control event has ended.
- Flashes continuously when the ATC/ Deep Snow & Mud switch is turned on, indicating that this feature is active.



WARNING

If this chassis is equipped with an electronic stability control (ESC) and is modified (e.g. adding or removing an axle, converting from a truck to a tractor, converting from a tractor to a truck, changing the body, lengthening of the wheelbase and/or frame, relocating frame components, or modifying pneumatic or electrical ABS/ESC harnesses) the ESC must be disabled by a qualified technician. If you have any questions, contact your authorized dealer. Failure to comply may result in death, personal injury, equipment or property damage.

**NOTE**

For more information about the stability control system installed on your vehicle, please refer to additional material supplied with this operator manual, included in your glove box informational packet.

Brakes, Anti-Lock Brake System

Illuminates during the Instrumentation System Self Test. Have the ABS system checked by an authorized dealer if the ABS Warning Lamp stays on for more than 3 seconds.

- Illuminates during normal operating conditions to indicate a problem with the ABS System.
- Illuminates when a problem exists with Automatic Traction Control (ATC).

Related concepts**Brake, Park Brake**

Illuminates in the status indicator when parking brakes are applied.

Brakes, Low Air

Illuminates when system air pressure falls below 60 psi.

Related tasks**Brake, Service Brake**

Indicates that a fault exists in the brake system. This should be checked by an authorized dealer as soon as possible.

Related concepts**Brakes, Trailer Anti-Lock Brake System**

Illuminates during the Instrumentation System Self Test and the tractor/truck is connected with a ABS equipped trailer. Illuminates during normal operating conditions to indicate a problem with the Trailer ABS System. This should be checked by an authorized dealer as soon as possible.

i NOTE

Tractors/Trucks and trailers built after 03/01/2001 must be able to turn on an In-Cab Trailer ABS Warning Lamp (per U.S. FMVSS121). The industry chose Power Line Communication (PLC) as the standard method to turn it on. On trailers built prior to 03/01/2001 verify trailer ABS system status via the required external warning lamp mounted on the trailer. The indicator lamp on the trailer should be yellow and identified with the letters ABS.

Related concepts

Differential, Inter Axle Lock



Illuminates when the inter-axle differential switch is ON thus locking the inter-axle differential. This powers the forward rear and the rear rear differentials equally. When the switch is turned off (inter-axle differential unlocked) the engine power is allowed to flow to any of the four drive tires

based on the differential effect (mostly to the forward rear differential). (This feature is standard on all tandem axles).

i NOTE

Tractors/Trucks and trailers built after 03/01/2001 must be able to turn on an In-Cab Trailer ABS Warning Lamp (per U.S. FMVSS121). The industry chose Power Line Communication (PLC) as the standard method to turn it on. On trailers built prior to 03/01/2001 verify trailer ABS system status via the required external warning lamp mounted on the trailer. The indicator lamp on the trailer should be yellow and identified with the letters ABS.

Dump Truck, Body Up



Illuminates when Truck Dump Body is up.

Dump Truck, Gate



Illuminates when Truck Dump gate is open.

Dump Truck, Trailer Body Up



Illuminates when Trailer Dump body is up.

Diesel Particulate Filter (DPF) Warning Lamp

This warning symbol will appear when the DPF needs to be regenerated and then also during the regeneration cycle. This icon may also appear if the system is attempting to automatically regenerate while the vehicle is in Power Take Off operation mode.

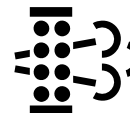

Engine aftertreatment system includes a diesel particulate filter and DPF warning lamp.

Emissions, High Exhaust System Temperature



WARNING

If this light is on, do not park in an area of combustible vapors or materials. You must keep combustibles at least five (5) feet away from the exhaust (outlet) stream (as it exits the tail pipe) while the HEST lamp is illuminated. Always park your vehicle outside. Failure to do so could ignite an explosion or harm bystanders which could result in serious injury.

WARNING

If this light is on, do not park in an area where people are close by. You must keep combustibles at least five (5) feet away from the exhaust outlet while the

HEST lamp is illuminated. Failure to do so could result in serious injury.

WARNING

If this light is on, temperature of the tailpipe, exhaust pipes, the diesel particulate filter (DPF) / selective catalytic reduction (SCR) device and surrounding components including enclosures and steps becomes elevated during engine operation or any regeneration event and can cause serious burns to the skin. Allow adequate cooling time before approaching, working on or near any part of the exhaust system or surrounding components.

Illuminates when the exhaust gas temperature and exhaust components become extremely hot.

Emissions, Malfunction Indicator Lamp



Illuminates when an engine emissions failure has occurred. The vehicle can be safely driven but should be serviced to correct the problem. The situation should not be considered an emergency. In some cases, the Malfunction Indicator Lamp will activate in conjunction with the High Exhaust Temperature, Diesel Particulate Filter (DPF) and Diesel Exhaust Fluid (DEF) Warning Lights.

Engine, Check Engine



Illuminates when a non emissions related problem exists, but the vehicle can still be safely driven. Vehicle should be serviced to correct the problem but the situation should not be considered an emergency.

Engine, Engine Fan



Illuminates when the engine fan is active. (Not available with optional Variable Speed Fan Drive)

Engine, Engine Block Heater



Illuminates when the engine block heater is turned on.

Engine, Low Coolant Level



Illuminates with an audible alarm indicating critically low coolant level. The vehicle must be serviced to correct the problem but the situation should not be considered an emergency.

Engine, Overspeed Air Shutdown



Illuminates when the Engine overspeed air shutdown system is activated.

Engine, Retarder (Brake)



Illuminates when the engine retarder (compression brake or exhaust brake) switch is turned on. (Engine retarders are an option.)

Engine, Stop Engine



Illuminates and an audible alarm tone will sound when a major engine system problem exists.



WARNING

If the Stop Engine warning lamp illuminates, it means you have a serious engine system problem. This should be considered an emergency. You should stop the vehicle as safely as possible and turn OFF the ignition. The vehicle must be serviced and the problem corrected before driving again. Failure to

comply may result in death, personal injury, equipment or property damage.

Related concepts

Engine Wait-To-Start Lamp

This warning icon will appear when the system needs some time before attempting to start the engine. The lamp will illuminate at key ON, and will stay on for a period of up to 30 seconds.





NOTE

The length of time the 'Wait-To-Start' lamp remains illuminated depends on the ambient temperature. The lower the ambient temperature, the longer the lamp will be illuminated.

Once the Wait-to-Start lamp turns off, turn the key to the starting position to start the engine.

You may see this appear if the system has detected a situation where the starter is too hot and needs to cool down. Alternatively, you may see it when the engine grid heater is on and needs some time to warm up. (PACCAR PX and Cummins ISL engines)

 NOTE
<p>Some engines are equipped with an engine starting motor protection feature. If the starting motor is engaged for 30 or more seconds, without the engine starting, the starter will be locked out from operating, allowing for proper cooling of the starting motor. During this time, the 'Wait-To-Start' lamp will flash for 2 minutes. Once the lamp stops flashing, the starting motor will be allowed to function.</p>

 NOTE
<p>Engines equipped with air starting motors require a minimum of 70 psi (480 kPa).</p>

Fuel Water In Fuel (WIF)



Illuminates when water has been detected in the fuel.

Lights, High Beam



Illuminates when the high beams are on. This icon will flash with audible alarm if the headlamps are left ON when the door is opened and the key switch is OFF. In addition, this icon will flash, but without an audible alarm, if there is a problem with the low beam headlights or the low beam headlight wiring. In such event, the high beam headlights will turn on at 50% normal brightness.

Lane Departure Warning (LDW)



Illuminates when optional LDW system is not able to track the vehicle's position within the lane.

 NOTE
<p>For vehicles equipped with Lane Departure Warning, please refer to Lane Departure Warning Driver's Guide for additional information.</p>

Power Take-off (PTO) Pump Mode



Illuminates with remote throttle application. Indicates pump mode is active.

Power Take-off (PTO)



Illuminates when the PTO is engaged.



NOTE

Do not drive vehicle with PTO engaged.

3

Refrigerator



Illuminates to indicate that the refrigerator is on and ignition is off.

Suspension Dump



Illuminates when suspension air bags are deflated.

Seat Belt Fasten



Illuminates when the ignition key is turned on as a reminder to fasten your seat belt.

Tire Inflation (TPMS)



Illuminates when tire pressures need to be checked. (Tire Pressure Monitoring System is an option.)

Transmission, Auxiliary



Illuminates to indicate auxiliary transmission is in neutral.

Transmission, Check



Illuminates when transmission has recorded a fault code. This icon may also appear in the Transmission Display menu of the Driver Performance Center. If the user is in this display menu, the icon does not indicate a fault code.

Transmission, Oil Temperature High



Illuminates when the oil in the main transmission becomes too hot.

Transmission, Retarder



Illuminates when BrakeSaver (export only) or Transmission Retarder is active.

**Transmission, Service
Transmission (Allison only)**



Illuminates when Allison 1000/2000 transmission requires service.

Turn Signal, Left



Blinks when the left turn signal or the hazard light function is operating.

Turn Signal, Right



Blinks when the right turn signal or the hazard light function is operating.

Optional Gauges

Listed here are gauges that may or may not be on your dashboard or the center instrument cluster.

For vehicles with a telematic navigation screen, optional gauges will be part of the screen functions. Please refer to the navigation system supplement for further details about its functions and how it works.

Axle, Pusher Air Pressure



The Pusher Axle Air Pressure gauge(s) indicate the air pressure in the pusher axle(s) suspension air bags. This icon may have a numeral above the image of the wheel to indicate which pusher axle if there are multiple pusher axles on the vehicle.

Axle, Tag Air Pressure

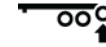

The Tag Axle Air Pressure gauge indicates the amount of air pressure in the tag axle suspension air bags. This icon may have a numeral above the image of the wheel to indicate which pusher axle if there are multiple pusher axles on the vehicle.

Fuel Filter Restriction



This gauge tells you the condition of the fuel filter by indicating the restriction from the fuel filter to the fuel pump. Check the engine manual for proper restriction. Replace the filter with an approved filter only. Do not substitute the wrong micron element.



NOTE

The maximum allowable restriction could vary according to the type or make of the engine. Consult the engine manufacturer's manual or engine dealer for fuel restriction specifications.

may cause damage to the engine. Inspect the filter and replace if necessary. Holes in the paper element render an air cleaner useless and may cause the Air Filter Restriction Gauge to give a false reading, even if the element is clogged. Replace the element if it is damaged.

maximum engine oil temperature recommended by the engine manufacturer. (See the Engine Operation and Maintenance Manual for details.)

Manifold Pressure Gauge

This gauge indicates the pressure in the intake manifold. The pressure in the manifold is directly related to the turbo output and is related to the engine power output.



If the pressure indicated by your manifold pressure gauge goes down, there may be something wrong with your engine. Have it checked by a qualified service person.

Fuel Pressure Gauge

Your vehicle may also have a fuel pressure gauge. This should not be confused with the standard fuel level gauge of the fuel tank.



3

Air Filter Restriction Indicator or Gauge

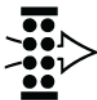

This gauge indicates the condition of the engine air cleaner and is measured by inches of water (H₂O). A clean filter should register 7 in. H₂O (may vary with system design) and a filter whose life is over will register approximately 25 in. H₂O.



CAUTION

Continued operation with the Air Filter Restriction Gauge reading 25 in. H₂O

Engine, Oil Pressure



It is important to maintain oil pressure within acceptable limits. If oil pressure drops below the minimum psi a red warning light in the gauge will turn on, the Stop Engine light will come on and an audible alarm tone will sound.

Engine, Oil Temperature

The Engine Oil Temperature gauge indicates the engine oil temperature.



If the oil temperature exceeds the maximum limits, a red warning light in the gauge will turn on. Do not exceed

 **WARNING**

Do not carry additional fuel containers in your vehicle. Fuel containers, either full or empty, may leak, explode, and cause or feed a fire. Do not carry extra fuel containers. Even empty ones are dangerous. Failure to comply may result in death or personal injury.

Transmission Temperature Gauge

Indicates the temperature of the oil in your transmission.



In addition to the warning icon in the center instrument cluster, watch this gauge to know when your transmission is overheating. If it is, have it checked by an authorized service representative. Maximum transmission temperature may vary, depending upon the transmission and type of lubricant. Check your transmission's owner's manual.

Drive Axle Temperature Gauge (Forward and Rear)

These gauges indicate the temperature of the lubricant in your vehicle's axle(s).



These temperatures will vary with the kind of load you are carrying and the driving conditions you encounter. Maximum axle temperature may vary, depending upon the axle and type of lubricant. Very high temperatures signal a need to have your axle(s) lubrication checked.

 **CAUTION**

Driving with very hot temperatures in your rear drive axles can cause serious damage to axle bearings and seals. Have your axle lubrication checked if you notice a sign of overheating.

Depending on the vehicle configuration, there may be a single gauge for more than just the forward and rear driver. The icon will have an "X" over the representative

axle to indicate which axle the temperature is being displayed in the gauge.

Suspension Load Air Pressure, #1, #2

The Suspension Load Air Pressure gauge indicates the amount of air pressure in the air suspension air bags.



When the vehicle is equipped with dual leveling valves, the #1 gauge indicates the air pressure in the driver's side air bags. The #2 gauge indicates the air pressure in the passenger's side air bags.

Tractor Brake Application Air Pressure



The Tractor Brake Application Air Pressure gauge indicates the amount of air pressure applied to the tractor brakes.

Trailer Brake Application Air Pressure



The Trailer Brake Application Air Pressure gauge indicates the amount of air pressure applied to the trailer brakes during brake foot valve and/or hand brake control valve applications.

Trailer Air Tank Air Pressure



The Trailer Air Tank Air Pressure gauge indicates the amount of air pressure in the trailer brake air tank.

Transfer Case Oil Temperature

The Transfer Case Oil Temperature gauge indicates the temperature of the oil in the transfer case.



If the oil temperature exceeds maximum limits, a red warning light in the gauge will turn on. Do not exceed maximum oil temperature recommended by the manufacturer. (See the Transfer Case Operation and Maintenance Manual for details.)

Transmission Oil Temperature, Auxiliary

The Auxiliary Transmission Oil Temperature gauge indicates the temperature of the oil in the auxiliary transmission.



Do not exceed maximum oil temperature recommended by the manufacturer. (See the Transmission Operation and Maintenance Manual for details.)



NOTE

Watch this gauge to know when the transmission is overheating

Transmission Retarder Oil Temperature

The Transmission Retarder Oil Temperature gauge indicates the temperature of the oil in the transmission retarder.



Do not exceed maximum oil temperature recommended by the manufacturer. (See the Transmission Operation and Maintenance Manual for details.)



NOTE

Watch this gauge to know when the transmission is overheating

Dash Switches

This custom vehicle will have a wide variety of switch controlled equipment. However, this particular vehicle may not

have every switch identified in this section of the operator manual. Some air device switches on the dash may require that the vehicle either be at a specific speed, park brakes set or another device to be on or off for the air device to operate. The

instrument display will display information regarding what needs to change in order for the air device to operate as expected. The following table provides a complete list of icons that may be found on the switch.

Title	Color	Standard or Optional
Axle, Differential Lock - Tridrive	Amber	OPT
Axle, Diff-Lock - Dual	Amber	OPT
Axle, Diff-Lock - Forward Rear	Amber	OPT
Axle, Diff-Lock - Rear Rear	Amber	OPT
Axle, Diff-Lock - Single Rear	Amber	OPT
Axle, Diff-Lock - Steer	Amber	OPT
Axle, Inter-Axle Differential Locked (Tandem)	Amber	OPT
Axle, Two Speed	Green	OPT
Back Up Alarm Mute	Amber	OPT
Batteries, Low Voltage Disconnect (LVD)	None	STD
Brakes, ABS Off-Road	Amber	OPT
Brakes, Parking Brake Valve	Red	STD
Brake, Trailer Hand	None	STD

Title	Color	Standard or Optional
Cab Dimmer Switch	None	STD
Dump Truck Gate	Red	OPT
Engine, Cruise Control On/Off	Green	STD
Engine, Cruise Control Set/Resume	None	STD
Engine, Fan Override	Green	OPT
Engine, Heater	Green	OPT
Engine, Overspeed Air Shutdown (Test)	Amber	OPT
Engine, Overspeed Air Shutdown (Manual)	None	OPT
Engine, Remote Throttle	Amber	OPT
Engine, Under Hood Air Intake	Amber	OPT
Exhaust, Diesel Particulate Filter (DPF) Regeneration	None	STD
Fifth Wheel Slide	Red	OPT
Fuel Heater	Amber	OPT
Generic Air, Accessory	Green	OPT
Generic, Spare SPARE	Green	OPT
Ignition Key Switch	None	STD
Lights, Auxiliary	Green	OPT

Title	Color	Standard or Optional
Lights, Beacon	Green	OPT
Lights, Daytime Running (Override)	Green	OPT
Lights, Dome	None	STD
Lights, Exterior Lights Self Test	None	STD
Lights, Flood	Amber	OPT
Lights, Flood ISO 3732 Spare	Amber	OPT
Lights, Fog	Green	OPT
Lights, Hazard	Red	STD
Lights, Headlight and Parking Lights	None	STD
Lights, Marker / Clearance / Cab	None	STD
Lights, Marker / Clearance / Trailer	None	OPT
Lights, Park Light	None	STD
Lights, Spot	Green	OPT
Mud and Snow Traction Control	None	STD
Pintle Hook	Green	OPT
Power Take-off (PTO)	Amber	OPT
Power Take-off (PTO), Forward	Amber	OPT
Power Take-off (PTO), Rear	Amber	OPT

Title	Color	Standard or Optional
Roofdenser	Green	OPT
Suspension, Air Retention	Amber	OPT
Suspension, Axle, Pusher	Green	OPT
Suspension, Axle, Tag	Amber	OPT
Suspension, Dump	Amber	OPT
Suspension, Third Axle Lift	Green	OPT
Trailer Air Supply	Red	STD
Trailer, Axle (3rd Axle) Lift	Green	OPT
Trailer, Axle Lift Forward	Green	OPT
Trailer, Axle Lift Rear	Green	OPT
Trailer, Belly Dump	Red	OPT
Trailer, Belly Dump Gate Center	Red	OPT
Trailer, Belly Dump Gate Front	Red	OPT
Trailer, Belly Dump Gate Rear	Red	OPT
Trailer, Dump Gate	Red	OPT
Trailer, Hotline	Green	OPT
Trailer, Suspension Air Dump	Amber	OPT
Transmission, Transfer Case	Amber	OPT

Title	Color	Standard or Optional
Transmission, Transfer Case 2 Speed	Amber	OPT
Winch Clutch	Green	OPT

Axle, Diff-Lock - Dual



Turn switch on to engage Front and Rear Axle Diff Lock.

Axle, Diff-Lock - Forward Rear



Turn switch on to engage Forward Rear Axle Diff Lock.

Axle, Diff-Lock - Steer



Turn switch on to engage Front Axle Diff Lock.

Axle, Diff-Lock - Rear Rear



Turn switch on to engage Rear Rear Axle Diff Lock.

Axle, Diff-Lock - Single Rear



Turn switch on to engage Single Rear Axle Diff Lock.

Axle, Inter-Axle Differential Locked (Tandem)



Turn switch on to engage Inter-Axle Differential Lock.

Axle, Differential Lock - Tridrive



Tridrives will have these axle differential lock controls and are 2 separate switches. **FRONT** will control the forward rear and **REAR** will control the center/rear-rear axle differential. In addition, a vehicle with Tridrive will have an interaxle differential lock switch.

Related concepts

Axle, Two Speed



If equipped, the two speed axle switch allows you to select axle high and low

ranges. The low range (Off) provides maximum torque for operating off-highway. The high range (On) is a faster ratio for highway speeds.

Back Up Alarm Mute



Turn switch on to mute Back Up Alarm.

	NOTE
The mute function use is discouraged. Only use mute when legally required.	

Batteries, Low Voltage Disconnect (LVD)



If your vehicle is equipped with a Low Voltage Disconnect (LVD) feature, the LVD is integrated into the main load center.

Brakes, ABS Off-Road



Turn switch on to engage ABS Off-Road mode.

Related concepts

Brakes, Parking Brake Valve



Pull yellow knob to activate parking brakes.

Related concepts

Brake, Trailer Hand



This dash mounted switch provides air pressure to apply the trailer brakes only. It operates independently of the foot treadle valve.

Cab Dimmer Switch



This switch is used to alter the brightness of the instrument panel lights.

	<p>NOTE</p>
<p>The Headlamp Switch is an ON or OFF switch. The panel lights are on full intensity during the day and go to Dimmer mode when headlamps are on.</p>	

Dump Truck Gate



Turn switch on to open Dump Truck Gate.

Engine, Cruise Control On/Off



Turn switch on to activate CruiseControl System. If the vehicle has the optional Predictive cruise control, this switch will have a different icon and will be located on the steering wheel.

Related concepts

Engine, Cruise Control Set/Resume



The Cruise Control Set/Resume switch allows you to **SET** the desired speed or **RESUME** the desired speed after the cruise control function has been interrupted.

Related concepts

Engine, Fan Override



The optional engine fan switch allows you to control the engine fan manually or automatically.

Related concepts

Engine, Heater



Turn switch on to activate the Engine Heater.

Engine, Remote Throttle



Turn switch on to activate Remote Throttle Control.

Engine, Overspeed Air Shutdown (Manual)



Turn switch on to engage the Engine Overspeed Air Shutdown system. A system reset will be required before re-

starting engine. See EOAS system manufacturer's instruction manual for details.

Engine, Overspeed Air Shutdown (Test)



Hold down switch and increase engine rpm to test that Engine Overspeed Air Shutdown system functions correctly. A system reset will be required before restarting engine. See EOAS system manufacturer's instruction manual for details.

Engine, Under Hood Air Intake

This switch opens a door in the engine air filter housing so that the air is taken from under the hood instead of outside air. This switch can be useful when starting the vehicle in cold weather conditions.



CAUTION

Only operate the under hood intake air switch when outside temperatures are below 32° F (0° C). Engaging the under hood air intake while temperatures are above freezing may result in engine damage.

Exhaust, Diesel Particulate Filter (DPF) Regeneration

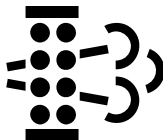

Manually controls the diesel particulate filter regeneration process. Refer to Engine Aftertreatment Controls Operator's Manual for additional information.

Fifth Wheel Slide



Turn switch on to "Unlock" Fifth Wheel Slide mechanism. The switch is guarded to protect you from accidentally activating or releasing the lock.



WARNING

Do not move the fifth wheel while the tractor-trailer is in motion. Your load could shift suddenly, causing you to lose control of the vehicle. Never operate the vehicle with the switch in the UNLOCK position. Always inspect the fifth wheel after you lock the switch to be sure the fifth wheel slide lock is engaged. Failure to comply may result in death, personal injury, equipment or property damage.

 **NOTE**

Vehicles having an air slide fifth wheel have a fifth wheel slider lock controlled by a switch on the instrument panel. By placing the switch in the unlock position you can slide the fifth wheel to various positions to adjust weight distribution.

 **NOTE**

The generic air accessory switch is designed by the original equipment manufacturer to reset when the ignition power is turned off. When ignition is turned off, this circuit will exhaust air pressure.

Fuel Heater



Turn switch on to activate Fuel Heater.

Generic Air, Accessory



Provides accessory air to the end of frame connection when switch is turned on.

Generic, Spare SPARE

SPARE

Turn switch on to power customer installed accessory.

Ignition Key Switch

The ignition key switch (located to the left of the steering column) has four positions: ACC (Accessories), OFF, ON, and START.

Lights, Auxiliary



Turn switch on for Auxiliary Lights.

Lights, Beacon



Turn switch on for Beacon Light(s).

Lights, Daytime Running (Override)



This switch overrides the normal operation of the Day Time Running Light (DRL) system. During normal operation the DRL will turn on lights when the headlights are turned off, engine is on and the park brakes are disengaged. The override switch will turn the DRL off in these instances. The DRL is also turned off when the headlights are turned ON.



WARNING

Do not use daytime running lights (DRL) during periods of darkness or reduced visibility. Do not use DRL as a substitute for headlights or other lights during operations that require lighting of your vehicle. Failure to comply may result in death, personal injury, equipment or property damage.

If the headlight switch is turned OFF, the DRL system engages automatically after the engine starts and you release the parking brake. If the headlight switch is ON, the DRL system is overridden, and headlights operate normally. Also, during engine cranking the DRL is temporarily turned off.

Lights, Dome



Turn switch on for Cab Dome Lights.

Lights, Exterior Lights Self Test



This switch will begin a sequence of turning on and off exterior lights so that the operator can verify functionality.

Related concepts

Related tasks

Lights, Flood



Turn switch on for cab mounted Flood Lights.

Lights, Flood (Spare)



Turn switch on for trailer mounted Flood Lights.

Lights, Fog



Turn switch on for Fog Lights.



NOTE

Across the U.S.A. and Canada, State/ Provincial requirements vary as to when high beams and fog lights can and cannot be used together. Some states allow only four lights to be used together, while some allow more. How your lights are arranged will affect whether you can operate headlights and fog lights concurrently always comply with the state or provincial requirements where you are driving.

Lights, Hazard



This switch operates the emergency flashers. With the switch in the ON position, the emergency flasher makes all four turn signals (front and rear) flash simultaneously. The flasher works independently of the ignition switch. You should always use the flasher if the vehicle is disabled or parked under emergency conditions.

WARNING

Use your Hazard Warning Light System any time you have to stop off the road or on the side of the road, day or night. A hard-to-see vehicle can result in an injury accident. Another vehicle could run into you if you do not set your flashers and follow the placement of emergency signals per FMCSR 392.22.

Lights, Headlight



Turn switch for park/markers lights and headlights. When the Headlights are ON,

the dash lights, side, and tail lights are also on. Headlights will turn on if the windshield wipers are turned on. Manually turning the headlights on and then off will override this function until the next time the vehicle is turned on.

CAUTION

If you have confirmed there is a problem in the low beam wiring circuit, proceed with caution to the next available exit/turnoff and safely pull your vehicle completely off the road and call for assistance. Driving your vehicle with the headlamps on high beam (at reduced intensity) for a prolonged period could lead to an injury accident. Contact your nearest dealer to have the problem corrected as soon as possible.

Lights, Marker/Clearance



Turn switch on to control Cab and Vehicle Marker/Clearance lights.



NOTE

An interrupt switch for the trailer marker lights is mounted on the end of the turn signal lever.

Lights, Marker/Clearance/Trailer

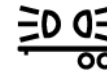

Turn switch on to control Trailer Marker/Clearance lights separately from the vehicle marker/clearance lights.

Lights, Park Light



Turn switch on for Park Lights. When the Park Lights are on the dash lights, side and tail lights are also on.

Lights, Spot



Turn switch on for Spot Light.

Mud and Snow Traction Control



Momentarily push switch in to engage Traction Control (TC).

Pintle Hook



Turn switch on to remove the slack from the Tow Hook.

Power Take-off (PTO)



This vehicle may be equipped with a dash mounted switch that controls PTO engagement/disengagement. When the operator activates the switch for the PTO, the status indicator lamp (located on the switch) will immediately illuminate even though PTO engagement may not have occurred. If the PTO is engaged and the operator turns the switch OFF, the PTO status indicator lamp (located on the switch) will go out immediately even though PTO disengagement may not have occurred.



NOTE

Actual PTO engagement/disengagement may be delayed momentarily since it is controlled by the air system and mechanical movement.



CAUTION

Increasing engine rpm before the PTO is actually engaged could prevent the

PTO from engaging and/or cause PTO damage.

Power Take-off (PTO), Forward



Your vehicle may be equipped with a dash mounted switch that controls forward PTO engagement/disengagement.

Power Take-off (PTO), Rear



Your vehicle may be equipped with a dash mounted switch that controls the rear PTO engagement/disengagement.

Suspension, Axle, Pusher



Turn switch on to lower Single or Forward Pusher Axle.

Suspension, Axle, Tag



Turn switch on to lower tag axle.

Suspension, Dump



Turn switch on to deflate suspension air bags. The switch is guarded to protect you from accidentally deflating the suspension.

WARNING

Do not operate the Air Suspension Deflate Switch (Dump Valve) while driving. Sudden deflation while your vehicle is moving can affect handling and control and could lead to an accident. Use this switch only when your vehicle is not moving.

CAUTION

Operating a vehicle with air suspension bags either overinflated or underinflated may cause damage to drive-line components. If a vehicle must be operated under such conditions, do not exceed 5 mph (8 km/h). Failure to comply may result in equipment damage.

Suspension, Air Retention

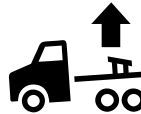

Suspension, Third Axle Lift



Turn switch on to raise Third Axle.

Trailer Air Supply

The red octagon knob controls the air supply to the trailer.

Trailer, Axle (3rd Axle) Lift

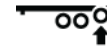

Turn switch on to lift 3rd Trailer Axle.

Trailer, Axle Lift Forward



Turn switch on to lift Forward Trailer Axle.

Trailer, Axle Lift Rear

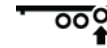

Turn switch on to lift Rear Trailer Axle.

3

Trailer, Belly Dump



Turn switch on to open Trailer Belly Dump.

Trailer, Dump Gate



Turn switch on to open Trailer Dump Gate.

Trailer, Belly Dump Gate Center

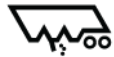

Turn switch on to open Trailer Center Belly Dump Gate.

Trailer, Belly Dump Gate Front



Turn switch on to open Trailer Front Belly Dump Gate.

Trailer, Belly Dump Gate Rear



Turn switch on to open Trailer Rear Belly Dump Gate.

Trailer, Hotline



Turn switch on to supply electrical power to trailer accessories.

Trailer, Suspension Air Dump

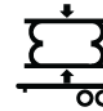

Turn switch on to deflate Trailer Air Suspension.

Transmission, Transfer Case



Turn switch on to shift the transfer case.

Transmission, Transfer Case 2 Speed



Turn switch on to shift the 2 speed transfer case.

Winch Clutch



Turn switch on to engage Winch Clutch.

Steering Column Controls

The steering column has controls for tilt/telescope, turn signal, wipers, engine brake and optional transmission controls.

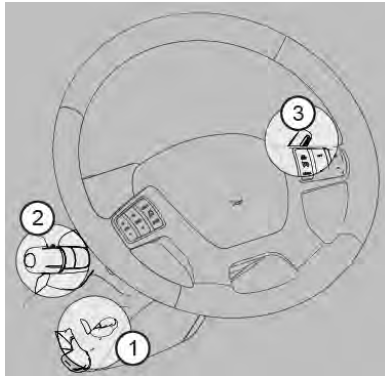

1. Tilt Telescoping Lever

2. Turn Signal/ Wiper/ Lights
3. Engine Brake (Optional Transmission Shifter)

The turn signal lever is mounted on the left side of the steering column. The lever controls several functions: turn signal, high beam, and windshield wiper control. The turn signal lever will only operate when the key is in the ignition in the ACC position.

Tilt/Telescoping Steering Wheel

Depending on your vehicle's configuration, you may have either a Tilt/Telescoping

- The tilt feature allows forward and rearward movement of the wheel.
- The telescoping feature allows you to move the wheel up and down.



WARNING

Make all adjustments to the steering mechanism while the vehicle is stopped. Adjusting the Tilt Telescoping Steering Wheel while the vehicle is in motion could cause loss of control. You wouldn't be able to steer properly and could have an accident resulting in death or personal injury.

How to Adjust Tilt/Telescoping Steering Column

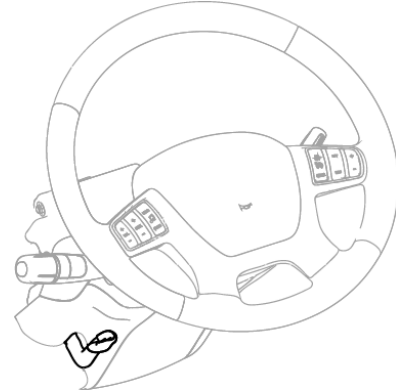

WARNING

Make all adjustments to the steering mechanism while the vehicle is stopped. Adjusting the Tilt Telescoping Steering Wheel while the vehicle is in motion could cause loss of control. You wouldn't be able to steer properly and could have an accident resulting in death or personal injury.

1. Locate the tilt telescoping lever

2. PUSH and HOLD the lever down fully.
3. Push or pull the wheel to the desired height and angle.
4. PUSH the lever back into the locked position.

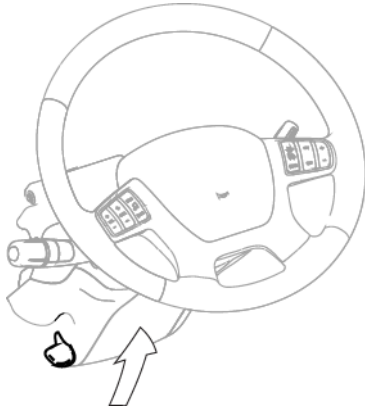

How to Use the Turn Signal

The lever-action turn signal/high beam switch is located on the left side of the steering column. Each time a turn indicator is activated the buzzer emits a short beep.

The ignition key must be turned to ON for the signal/switch to operate.

NOTE

If the vehicle turn signals and turn signal indicators in the dash gauge cluster ever begin flashing at an accelerated rate (115 cycles per minute) when the turn signal lever is in the OFF (center) position, or when a Right/Left turn has been selected, the problem may be related to a failed turn signal switch or turn signal module. In either case, the problem is not a failed bulb. Contact your nearest authorized dealer to have the problem corrected as soon as possible.

1. Push the lever up to engage the RIGHT turn signal and down to engage the LEFT turn signal.



2. Release the signal stalk
3. The turn signal will cancel when the turn is complete.

Each time the turn indicator is activated the audible warning emits a short beep.



WARNING

After you complete a turn, shut the system off by returning the lever to the "OFF" (center) position. Failure to shut off a turn signal could confuse other drivers and result in an injury accident. An indicator light in the instrument panel will flash until the turn signal is turned off.

How to Turn on High Beams

The high beam function is operated by the same steering column lever for the turn signals. High beams will not turn on if the headlights are turned off.

1. Gently pull the turn signal lever, toward the steering wheel, until you hear the switch click and the beam changes.



2. To return to previous beam: pull the lever towards the steering wheel again.

The blue indicator light in the instrument panel will turn ON and the high beams will turn on.

How to Momentarily Flash High Beams

The "flash to pass" high beam function is operated by the same steering column lever for the turn signals. The high beam flash to pass will work if the headlights are not on.

1. Gently push the turn signal lever, away from the steering wheel.

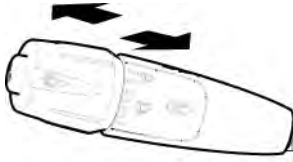

2. The lever will automatically return when the lever is released.

The blue indicator light in the instrument panel will momentarily turn ON and the high beams will flash. The high beams will not remain on if the lever is still pressed.

	NOTE
<p>The "flash to pass" functionality of the headlight switch is not available for vehicles manufactured with High Intensity Discharge (HID) headlamps. Please check with local regulations regarding restrictions on using high beam flashing.</p>	

	NOTE
<p>Continued pressing of the high beam flash will not keep the high beams on.</p>	

How to Flash Marker and Clearance Lights

A button on the turn stalk will momentarily flash the marker and clearance lights when pushed.

1. Push the small button on the end of the turn stalk



Operate the Windshield Wipers

This vehicle is equipped with a two speed, intermittent windshield wiper system. The windshield wiper system is integrated with the exterior lights so that the low beam headlights will turn on when the windshield wipers turn on.

	WARNING
<p>Clean blades regularly with a damp cloth to remove road film and wax buildup. Do not drive with worn or dirty wiper blades. They can reduce visibility, making driving hazardous which may lead to an injury accident resulting in death or personal injury.</p>	



CAUTION

DO NOT use antifreeze or engine coolant in the windshield washer reservoir, damage to seals and other components will result.

To override this function, turn the headlights on and then off again and the low beams will turn off. Permanently overriding this functionality is attainable via the Settings Menu in the instrument cluster display. Go to Settings - > Wiper Interlock and turn this value to OFF.

Avoid running the wiper blades over a dry windshield to prevent scratching the glass. Spray on washer fluid first. A scratched windshield will reduce visibility.

A seven-position rotary wiper switch (located on the turn signal lever) operates the windshield wipers and washer. If you need to use the windshield wipers:

1. Rotate the end of the turn signal lever to change the wiper mode from off to on.
2. Continue to rotate the outer knob of the turn stalk lever to adjust the wiper speed.

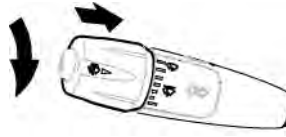

- 4 levels of intermittent speeds
- Low wiper speed
- High wiper speed

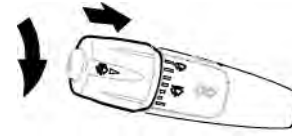

- Press and hold will activate the washer fluid and wipers.
- Instant press and release will activate the washer fluid only.

How to Spray Windshield Washer Fluid

This vehicle is equipped with a function to wash the windshield and simultaneously engage the wipers.



CAUTION

If the electric pump is operated for a long period (more than 15 seconds) with a dry reservoir, the pump motor may be damaged.

If you need to use the windshield wipers washer:

1. Push the outer knob in.

Controls on the Right Hand of the Steering Column

The lever on the right hand side of the steering column will operate the engine brake for vehicles with manual transmissions and Allison Automatic transmissions.

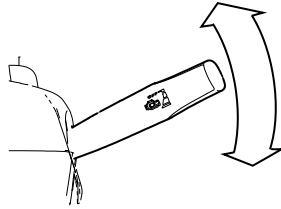

Related concepts

Controls on the Right Hand of the Steering Column

This vehicle may be equipped with the PACCAR Transmission. The lever on the right hand side of the steering column will operate the transmission functions in addition to operating the engine brake.

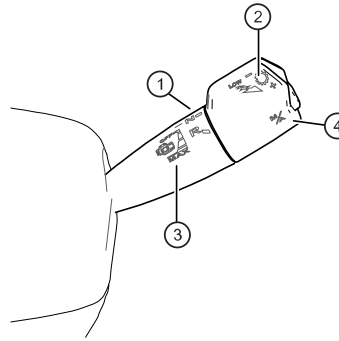

- 1 Transmission **D - N - R** Function
- 2 Up (+) and Down (-) Shift and **Low** Mode
- 3 Engine Brake and **Max** Mode
- 4 Manual (**M**) / Automatic (**A**) Mode Button

Related concepts
Related tasks

Steering Wheel Controls (Optional)



CAUTION

Under no circumstances should you attempt to service the steering wheel, clockspring, or any of the electrical wiring in the multiplex system, or any steering components (steering column, steering driveline or steering gear). Tampering with these components may result in an inoperable multiplex system.

The steering wheel contains controls for commonly used functions so that the operator does not have to take their hands off of the steering wheel to operate.

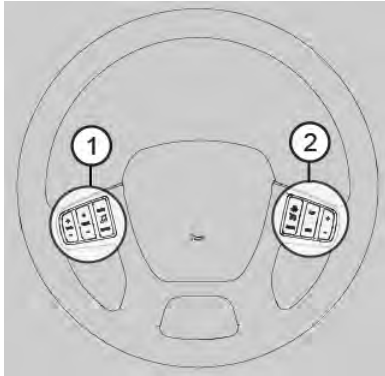

1. Left Switch Pod
2. Right Switch Pod

Left Switch Pod



The switches on the left side of horn pad control music.

Right Switch Pod



The switches on the right side of horn pad control cruise control features. (If the vehicle has optional Predictive Cruise Control, then these switches will operate that system.)



WARNING

Do not operate the cruise control when operating on road surfaces with poor traction (wet, icy, or snow covered roads) or in heavy traffic. Accelerations caused by the normal operation of the cruise control could cause you to lose control of the vehicle resulting in an injury accident.

City Horn

Depressing the bottom center bar activates the electric horn.

Look for this symbol on the center pad of the steering wheel

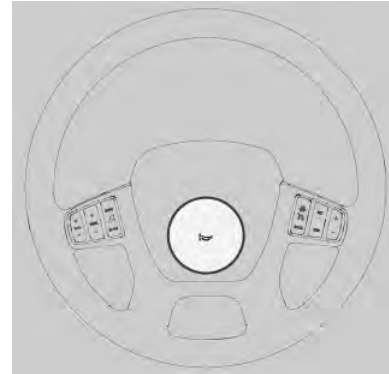

To use the electric horn, press the button in the center of the steering wheel, which is the standard location for electric horns. Your vehicle may be equipped with air horns. To operate, pull on the lanyard extending from the overhead header panel.

Door Mounted Controls

Controls for mirrors, door locks, mirrors and windows are located on the door pad.

If your vehicle is equipped with power mirrors, the mirror controls will be located on the driver side door pad. Mirrors can be adjusted in four directions. To provide good visibility, adjust the mirror so the side of your vehicle appears in the inboard part of the mirror.

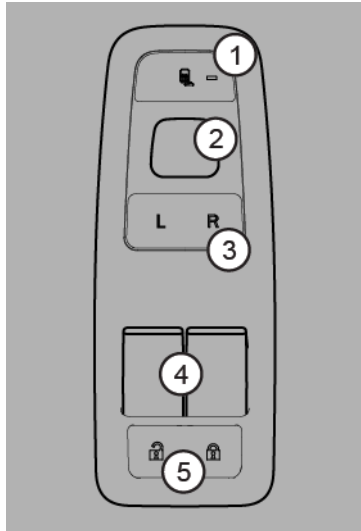

1. Mirror Heat
2. Mirror Adjust
3. Left or Right Mirror Adjust Selector
4. Window Controls
5. Door Lock Control

Door Mounted Mirror Controls

If your vehicle is equipped with power mirrors, the mirror controls will be located on the driver side door pad. Mirrors can be adjusted in 4 directions. To provide good visibility, adjust the mirror so the side of your vehicle appears in the inboard part of the mirror.

3

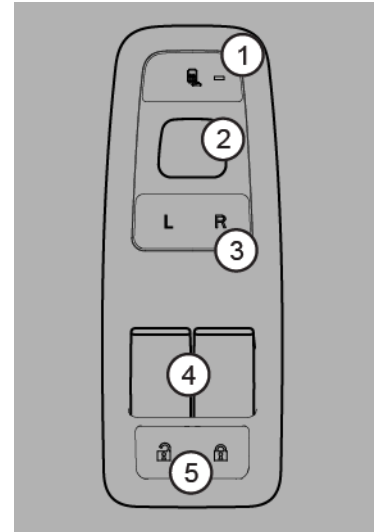

1. Mirror Heat

2. Mirror Adjust
3. Left or Right Mirror Adjust Selector
4. Window Controls
5. Door Lock Control

Mirror Heat Switch

Your vehicle may be equipped with optional heated mirrors. Mirror heat is controlled by the mirror heat switch button, which is part of the mirror switch module located on the driver side door pad. If the vehicle has optional hood mounted heated mirrors, this switch will also activate heat to those mirrors.

Power Mirror Switch

If your vehicle is equipped with power mirrors, the directional controls for both mirrors are located near the top of the driver side door trim pad.

Power Door Lock Switch

Power door lock rocker switches are located on the door pads. To lock or unlock both cab doors as well as a sleeper door, depress any door lock switch at the end that displays a closed or open padlock symbol, respectively, on the switch face.

Power Window Switch

Power window rocker switches are located on the door pads. Depress the switch to open the window or pull up on the switch to close the window. Release the switch to stop window movement. The drivers side window has an express down feature. Pushing on the switch all the way down until the switch bumps will activate the express down feature. Release the button and the window will continue to open until it is completely open.

How to Use Power Mirror Adjustment Switches

Use these instructions to adjust the power mirrors on the vehicle.



WARNING

Adjust all mirrors before driving. Adjusting the mirrors while driving can cause you to take your eyes off the road, which could result in an accident. Failure to do so could lead to serious injury or equipment damage.



WARNING

Convex mirrors can distort images and make objects appear smaller and farther away than they really are. You could have an accident if you are too close to another vehicle or other object. Keep plenty of space between your vehicle and others when you turn or change lanes. Remember that other objects are closer than they may appear.

1. Move the mirror selector switch (3) to the right or left from the neutral center position to select the desired mirror for adjustment.
2. Depress the mirror directional control pad (2) in one of its four arrow directions to adjust the mirror in/out or up/down.
3. To provide good visibility, adjust the mirror so the side of your vehicle appears in the inboard part of the mirror.
4. After mirror adjustments have been completed, return the mirror selector switch back (3) to the center (neutral) position to prevent

unintentional adjustments to the mirrors.

Ignition Key Switch

General information on the operation of the ignition key switch.

The ignition key switch (located to the left of the steering column) has four positions: ACC (Accessories), OFF, ON, and START.



OFF: In this position all accessories are OFF (except those listed below) and you can remove the key.

The following lights and accessories have power when the key is in the OFF position:

- brake lights
- emergency hazard flasher

- dome and courtesy lamps (on doors)
- electric horn
- cigarette lighter
- tail lights
- marker lamps
- headlights
- radio station memory
- instrument lights
- auxiliary power
- instrument panel memory settings

ACC (Accessory): With the key in this position you can play the radio, defrost mirrors (if equipped with mirror heat) or use other accessories.

ON: In the ON position all circuits are energized. Panel warning lights will light and the buzzer will sound until (1) the engine is started, (2) normal oil operating pressure is reached, and (3) air brake system pressure is above 65 psi (441 kPa). In this position, the ignition key cannot be removed.

START: Turn the key to this position to start your engine. Release the key after the engine has started.

Related concepts

What is the Exterior Lights Self Test

This feature allows the operator to verify and inspect exterior lighting operation typically performed during a pre-trip inspection.

When the feature is engaged, via a switch on the dash, it will illuminate the:

- Park lights
- Side marker lights
- Hazard/turn signals
- Lo beam headlamps
- First set of fog/driving lights

The test will turn those lights off and then illuminate the:

- Park lights
- Side marker lights
- Hi beam headlamps
- Stop/Brake lights

After turning these lights off, the system will resume testing the first set of lights.

The light test will eventually stop on its own. The operator may interrupt the test by turning the vehicle off or pressing the

switch a second time while the test is running. The operator can verify the light functionality by visibly watching the light from outside the vehicle during the test or can read the instrument cluster for any faults displayed that are lighting related.

How to use the Exterior Light Self Test Switch

To start the Exterior Light Self-Test (ELST) feature:

1. Park the vehicle and set the parking brakes.
2. Insert the key into the ignition, start the engine and allow the vehicle to run through its own Power On Self Test.
3. Press the momentary switch on the dash to start the ELST.



Heating and Air Conditioning

This vehicle's heating and air conditioning system operates in four distinct modes: manual, automatic, semi-automatic, and maximum defrost. Each mode provides the driver with the greatest level of comfort and convenience while maintaining the flexibility of traditional systems.

The recommended mode for all conditions that do not require windshield defrosting is the automatic mode. This mode is capable of maintaining cab comfort under various driving conditions without driver interaction. The cab heater and air conditioner controls are located together in the center of the dash just to the right of the steering column. The sleeper heater and air conditioner controls are located in the sleeper cabinet.



WARNING

Do not drive with visibility reduced by fog, condensation, or frost on the windshield. Your view may be obscured, which may result in death, per-

sonal injury, equipment or property damage. For clear visibility and safe driving it is extremely important for you to follow the instructions pertaining to the function and use of the ventilation/heating and defogging/defrosting system. If in doubt, consult your dealer. Maximum heating output and fast defrosting can be obtained only after the engine has reached operating temperature.



WARNING

Exhaust fumes from the engine contain carbon monoxide, a colorless and odorless gas. Do not breathe the engine exhaust gas. A poorly maintained, damaged or corroded exhaust system can allow carbon monoxide to enter the cab. Entry of carbon monoxide into the cab is also possible from other vehicles nearby. Failure to properly maintain your vehicle could cause carbon monoxide to enter the cab, resulting in death or personal injury.

**WARNING**

Never idle your vehicle for prolonged periods of time if you sense that exhaust fumes are entering the cab. Investigate the cause of the fumes and correct it as soon as possible. If the vehicle must be driven under these conditions, drive only with the windows open. Failure to repair the source of the exhaust fumes may result in death, personal injury, equipment or property damage.

**CAUTION**

Do not stay in the vehicle with the engine running or idling for more than 10

minutes with the vehicle's Heater and A/C ventilation system in RECIRC or at LOW FAN SPEED. Even with the ventilation system on, running the engine while parked or stopped for prolonged periods of time is not recommended.

**NOTE**

Keep the engine exhaust system and the vehicles cab ventilation system properly maintained. It is recommended that the vehicles exhaust system and cab be inspected (1) By a competent technician every 15,000 miles (24,140 km) (2) Whenever a change is noticed in the sound of the exhaust system (3) Whenever the exhaust system, underbody, or cab is damaged.

**NOTE**

If you are required to idle your vehicle for long periods of time, install an auxiliary heater or automatic idle control. These auxiliary devices can reduce fuel consumption and save you money.

**NOTE**

If you are parked next to idling vehicles, move your vehicle or do not stay in your vehicle for prolonged periods of time.

Air Conditioner Controls

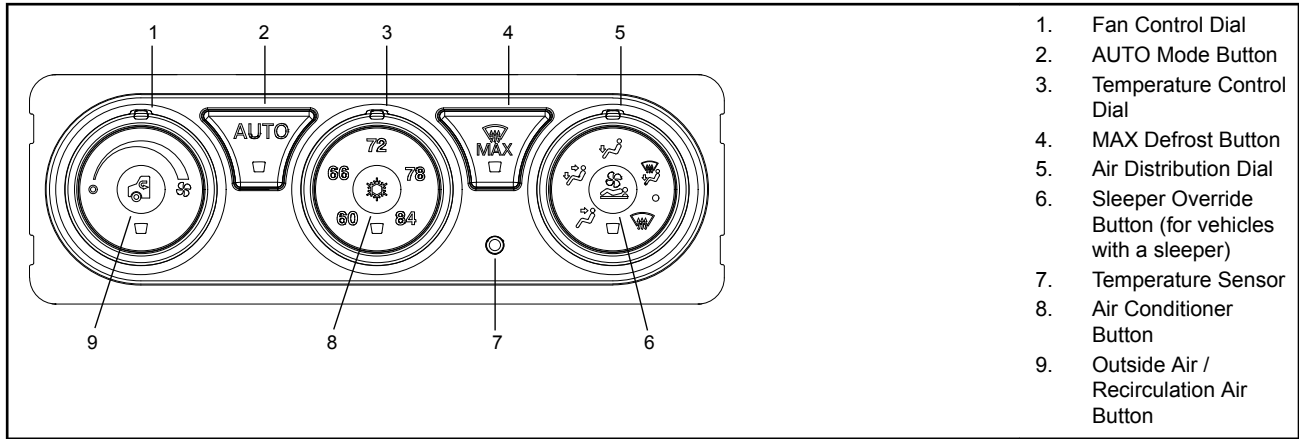

1. Fan Control Dial
2. AUTO Mode Button
3. Temperature Control Dial
4. MAX Defrost Button
5. Air Distribution Dial
6. Sleeper Override Button (for vehicles with a sleeper)
7. Temperature Sensor
8. Air Conditioner Button
9. Outside Air / Recirculation Air Button

Air Conditioning Functions

These symbols for the air conditioner operate various system functions.

Symbols for the air conditioning control panel

Image	Function
	The source of air entering the cab can be set to either outside air or recirculation air using the button

Image	Function
	inside the fan speed control dial. Recirculated air is automatically selected in defrost modes.



Image	Function
	The fan speed is adjusted by rotating the dial clockwise to increase speed or counterclockwise to decrease speed. Setting the fan dial to "O" turns the HVAC system off.
AUTO	Automatic air conditioner function
	The button inside the temperature control dial engages the A/C compressor. When activated the indicator on the button will illuminate. During AUTO mode, the A/C button indicator will remain illuminated at all times even though the







Image	Function
	compressor may be cycling. Max defrost function
	Power to the sleeper HVAC unit can be toggled using the button inside the air distribution dial. When activated, the indicator on the button illuminates. The sleeper HVAC unit will function to the settings of the sleeper control.
	Floor Vents
	Defrost Vents (and Fresh air intake)
	Panel and Floor Vents

Image	Function
	Panel Vents
	Floor and Defrost Vents (and Fresh air intake)

How to Manually Control the Air Conditioner for the Cab

Information on controls to set cab heating and air conditioning.

Temperature Control Set Point The cab temperature is set using the temperature control dial. The operating range is 60°F (16°C) and 84°F (28°C). Adjustments of 2° increments.

Air Conditioner Button The button inside the temperature control dial engages the A/C compressor. When activated the indicator on the button will illuminate. During AUTO mode, the A/C button indicator will remain illuminated at all times even though the compressor may be cycling.



NOTE

Fan Control Dial must also be in the ON position for A/C to be on. A/C engages automatically in AUTO, defrost and floor/defrost.

3

The air conditioner defaults to Manual mode when turned on. The fan speed, air temperature, and air outlets are selected using the dials on the controller.

1. To adjust the fan speed, turn the fan control dial clockwise to increase speed or counterclockwise to decrease speed. Setting the fan dial to "O" turns the HVAC system off.
2. To adjust the temperature setting, turn the temperature control dial to the desired temperature. The system automatically adjusts the outlet air temperature to achieve the desired cab temperature.
3. Push the snowflake button if the air temperature needs to be colder, this button will manually turn on the compressor.
4. To adjust the air distribution, turn the air distribution dial to the

desired position as indicated by the graphics.

5. Select the recirculation button for FRESH or RECIRC air.

The temperature of the air from the vents will fluctuate as the vehicle works to achieve the chosen cab temperature. When idling for short periods of time, keep the fan ON and set the air mode to FRESH air. For vehicles with a sleeper, the cab control can be used to activate/deactivate the sleeper HVAC using the button inside the mode dial.

What is Auto Mode for the Air Conditioner

Setting the air conditioner for automatic temperature control.

The Auto Mode will manipulate the air distribution, air temperature, fan speed, A/C compressor, and cab air recirculation to achieve the comfort level selected on the temperature dial. Depending on the specific environmental conditions, the air temperature can be slightly higher or lower than the set point. This is a normal function of the AUTO mode and is not to be mistaken for a malfunctioning system. The button that enables automatic mode is labeled **AUTO**.

AUTO

The system will remain in automatic mode until the driver adjusts the dials on the control. Adjust the temperature knob and the system will respond to obtain the selected comfort level as quickly as possible.



The cab temperature is set using the temperature control dial. The operating range is 60°F (16°C) and 84°F (28°C). Adjustments of 2° increments.

The AUTO function uses a sun light sensor to measure the amount of sunlight entering the cab. This sensor is located at the base of the windshield on the driver's side of the instrument panel. Do not block this sensor.

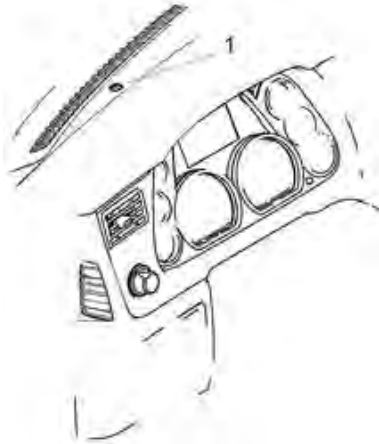

1. Sunlight Sensor

Semi-Automatic Mode

During AUTO mode the operator may override any setting and operate in a semi-automatic mode. This can be done via the dials and/or buttons on the HVAC control. In the partial automatic mode, the AUTO button indicator will cease to be illuminated. Instead, the indicator of the adjusted setting will illuminate. For example, if the driver adjusts the fan dial while in AUTO mode, the fan dial indicator

will illuminate and fan speed will adjust to the setting of the dial. However, the temperature and air outlet settings will continue to function automatically. Similarly, if user adjusts the air distribution setting while in AUTO mode, the air distribution dial indicator will illuminate and the distribution will adjust to the setting of the dial. The fan and temperature settings will continue to function automatically.

Economy Function

An economy function is also available in partial automatic mode. In this mode the system will operate in AUTO mode without the use of the A/C compressor. The operator may select economy by initiating AUTO mode and then pressing the A/C button to disengage the compressor. The indicators for A/C compressor and AUTO mode do not illuminate while operating in economy mode.

How to Operate Automatic Cab Air Conditioner

This air conditioning system feature provides complete cab climate control without driver interaction.

Follow these steps to activate the Auto Mode:

1. Turn on **HVAC** by rotating fan speed control clockwise.
2. To engage automatic mode, press the **AUTO** button.
3. To adjust cab temperature, rotate the temperature dial to the desired temperature. The system automatically adjusts to achieve the desired cab temperature.

The system will achieve the comfort level associated with the selected temperature on the temperature dial. Therefore, depending on the specific environmental conditions, the air temperature can be slightly higher or lower than the set point. This is a normal function of the **AUTO** mode and is not to mistaken for a malfunctioning system.

MAX Defrost Mode

Information on using HVAC maximum defrost.

The heating and air conditioning system provides for one touch windshield defrosting. Certain driving conditions will cause fog or ice to form on the windshield. By pressing the **MAX** defrost button, the system will automatically adjust the blower speed, air temperature, and air outlet

distribution to maximize clearing of the windshield. The system will remain in this mode until the driver presses the button again or adjusts the dials.



The air temperature in MAX defrost mode will be set to the warmest temperature setting. This setting helps to clear the windshield of ice and fog more quickly. Outside air mode and the air conditioner compressor are also active to maximize performance. The A/C compressor and recirculation switches are disabled in MAX Defrost.

Sleeper Heater and Air Conditioner Controls (Optional)

General information about the sleeper heater and air conditioner controls.

Unlike the cabin air temperature controls, the sleeper temperature control will alter the air temperature based on the knob setting.

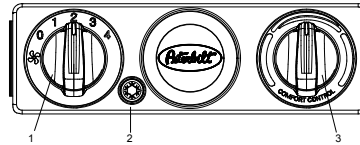

1. Air Speed
2. Compressor
3. Temperature Adjustment

The temperature control is not keyed to specific temperatures. Turning counterclockwise means cooler than it is now. Clockwise means warmer than it is now. Once the desired temperature is reached, the system will maintain it automatically. A separate switch on the dash HVAC unit will send power to the "bunk" or sleeper control unit. The button on the cab HVAC unit must be pressed and in the ON mode to use the sleeper controls.

Power to the sleeper HVAC unit can be toggled using the button inside the air distribution dial. When activated, the indicator on the button illuminates. The sleeper HVAC unit will function to the settings of the sleeper control.

NOTE

On the Cab Control Unit, the sleeper enable switch must be pressed to turn ON power to the sleeper control unit. In addition, if air conditioning is requested in the sleeper, the air conditioner switch on the cab control unit will be turned ON and fan in the cab heater and air conditioning unit will be turn on low (if it was OFF) automatically.

NOTE

The sensor is located on the sleeper heater -A/C control panel and measures the sleeper air temperature at the panel. There will be a time delay between temperature control adjustment and sleeper air temperature change. Also, be careful of any heat source which could affect the air temperature by the sensor. Avoid hanging items (eg shirt, jacket, hats) which could block the air flow to the sensor

Air Conditioner Operating Tips

Common operating tips to maximize the effectiveness of the cab air conditioner.



CAUTION

During extreme cold weather, DO NOT blow hot defroster air onto cold windshields. This could crack the glass. Turn the Air Flow Control Dial to Defrost and adjust the fan speed accordingly while the engine warms. If the engine is already warm, move the Temperature Control Dial to "cool," then gradually increase the temperature when you see that the windshield is starting to warm up. Failure to comply may result in equipment damage.

Defrosting and Defogging the Windshield

The cab windshield and side windows can be cleared of ice and fog in two ways. The first is to use the **MAX** defrost mode. The second is to manually adjust the air distribution dial to the defrost position. The manual defrost/defogging mode differs from the **MAX** defrost mode by allowing the driver to select an air temperature other than full heat. This allows the driver to

maintain a constant cab temperature while defrosting the windshield. Note however that performance may be reduced.

- Adjust the fan speed to high by rotating the fan control dial clockwise.
- Set the air distribution dial to the defrost mode setting. This automatically engages the outside air and the air conditioner compressor.
- Adjust the temperature dial to add heat as needed.

For maximum performance, adjust the temperature to maximum heat by rotating the temperature dial clockwise. The driver may also use the floor/defrost setting on the air control

For Maximum Cooling

- Adjust the fan speed to high by rotating the fan control dial clockwise.
- Set the air distribution dial to the panel setting.
- Adjust the air temperature to maximum cool by rotating the temperature dial counterclockwise.

- Engage the air conditioner compressor by pressing the air conditioner button.
- Set the air source to recirculation mode by pressing the outside air / recirculation air button. The button indicator light should be illuminated.

For Maximum Heating

- Adjust the fan speed to high by rotating the fan control dial clockwise.
- Set the air distribution dial to the floor setting.
- Adjust the air temperature to maximum heat by rotating the temperature dial clockwise.



NOTE

The engine must be at operating temperature for maximum heating. If operating in AUTO mode, heating airflow is not allowed until the engine warms sufficiently to provide required coolant temperatures.

Air Dehumidification

The air conditioner system can be used to reduce the humidity level of the cab and clear fog from the windshield.

- Adjust fan speed to the desired airflow setting.
- Engage the air conditioner compressor by pressing the air conditioner button.
- Set the air source to outside air mode by pressing the outside air / recirculation air button. The button indicator light should NOT be illuminated.



NOTE

That the A/C compressor may not engage when the outside temperature is below 34°F (1°C).

Cab Air Distribution

Equal distribution of air is important in maintaining a constant cab interior temperature. For best performance, all vents should remain open to allow the AUTO mode to function properly. To maintain the selected cab temperature the AUTO mode may provide an air

temperature from the vents that differs from the temperature set point. To ensure proper operation, it is recommended that the driver redirects the air instead of adjusting the temperature set point or closing the vent. The system may have difficulties in obtaining the desired cabin temperature if the temperature setting is repeatedly changed.

The mode of air distribution inside the cab is set using the air distribution dial. Five icons on the dial indicate the primary mode options. The driver may also select a secondary mode in between the primary modes indicated by points on the dial. Airflow is provided to the side windows in all modes.

Outside Air / Recirculation Air

Selecting air recirculation mode completely isolates the cab interior from the outside air. This mode is helpful in preventing dust, pollen, and odors from entering the cab. Additionally, recirculation mode can reduce the amount of time needed to cool down the vehicle while in maximum cool down. Note that the mode may increase fogging on the windshield. A coarse air filter is provided for recirculation air and is located under the IP. The outside air mode provides for 100% outside air into the cab.

This mode is helpful with windshield defogging. A pleated air filter located under hood provides filtration for dust, pollen, and debris. If equipped, your vehicle may also provide for ember filtration or fine particulate filtration.

Related concepts

Sleeper Alarm Clock

The Optional Sleeper may include an alarm clock for the sleeper occupants.

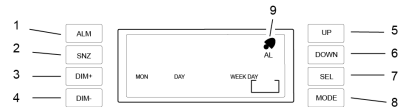

1. Alarm - press to turn on the alarm
2. Snooze - press to snooze the alarm bell
3. Dimmer/brighter - press to make display brighter
4. Dimmer/darker - press to make display less bright
5. Increase value of setting
6. Decrease value of setting

7. Select - press to choose the setting being changed while adjusting the either the time or the alarm
8. Time and Alarm value setting - press to change time/date and or alarm setting
9. Active alarm icon - alarm is activated when this icon appears

Turning the Alarm On/Off

Press the **ALM** button to turn the alarm on and off. The icon (9) will illuminate when the alarm is active. When time reaches the set time the alarm will ring. If the **SNZ** button is not pressed, the alarm will continue ringing for 15 minutes then will automatically stop. Pressing any other button except **SNZ** (2) will turn the alarm off.

Snooze Operation

When the alarm is ringing press the **SNZ** button (2) to silence the alarm for 9 minutes. The small bell icon (9) will flash until the alarm is shut off. The **SNZ** button can be used as many times as desired.

Dim Control Operation

Press the DIM+ or DIM- buttons (3, 4) to change the brightness of the display.

Set the Sleeper Alarm Clock Time

These are instructions to set the time on the optional alarm clock installed in the sleeper.

1. Press the **MODE** button until the screen begins flashing.
2. Use the **UP** and **DOWN** buttons to adjust the value.
3. Press the **SEL** button to adjust the next setting and use the **UP** and **DOWN** buttons to change the value.
4. Repeat this for all settings. The alarm clock will scroll in the following order each time you press the **SEL** button.
 - Year
 - Month
 - Day
 - Hours
 - Minutes
5. Press the **MODE** button once you have set the minutes which will exit and save your settings.

Set the Sleeper Clock Alarm

These instructions are to set the time for which the alarm will sound.

1. Press the **MODE** button twice until the screen displays the AL icon.
2. Use the **UP** and **DOWN** buttons to adjust the setting.
3. Press the **SEL** button to adjust the next setting and use the **UP** and **DOWN** buttons to change the setting.
4. Repeat this for all areas. The alarm clock will scroll in the following order each time you press the **SEL** button.
 - Hours
 - Minutes
5. To exit and save your settings, press the **MODE** button once you have set the minutes.

Cab Accessories

General accessories in the cab.

Radio (Optional)

As an option, your vehicle has either an AM/FM Stereo Receiver, which may or may not have a CD, or may have the stereo system integrated with your Navigation and telematics unit. For

instructions on how to operate your particular radio, see the supplemental operating manual for those units.

Cigarette Lighter and Ashtray (Option)



NOTE

The 12V accessory power port will operate with the ignition key in either the OFF, ACC (accessory), or ON position.

This vehicle comes standard with two cupholders and power ports located in the center of the dashboard. This vehicle may have the optional ashtray insert (for the cupholder) and the optional cigarette lighter instead of a power port. To operate, push in on the knob end of the lighter. After a few moments, the lighter will automatically pop out, glowing hot and ready to use. After use, insert the lighter back into the socket without pushing all the way in. The socket of the cigarette lighter may be used to operate 12 volt, 15 amp appliances, such as a hand spotlight or small vacuum cleaner.



CAUTION

Do not attempt to operate a cigarette lighter using the 12v power port receptacle. A cigarette lighter inserted into the 12v power port will heat up and be expelled into the cab, potentially causing personal injury, fire and property damage.



WARNING

Do not place paper or other combustible substances in an ashtray, it could cause a fire. Keep all burnable materials, besides smoking materials, out of the ashtray. Failure to comply may result in death, personal injury, equipment or property damage.



WARNING

Do not exceed the voltage/amperage capacity of the accessory power port. It could result in a fire. Follow all warnings and instructions in the operator's manual for the appliance you are us-

ing. Failure to comply may result in death, personal injury, equipment or property damage.

Glove Box

A glove box is provided to store important documents, the vehicle literature set (including this Operator's Manual) and other related materials. You can choose from a variety of other interior storage options to store your personal supplies or small tools:

- center console
- map pocket on the door
- overhead storage compartments



WARNING

Do not drive with the glove box open, it can be dangerous. In an accident or sudden stop, you or a passenger could be thrown against the cover and be injured. To reduce the risk of personal injury during an accident or sudden stop, keep the glove box closed when the vehicle is in motion.

**WARNING**

Do not carry loose objects in your cab, it can be dangerous. In a sudden stop, or even going over a bump in the road, they could fly through the air and strike you or a passenger. You could be injured or even killed. Secure all loose objects in the cab before moving the vehicle. Carry any heavy objects such as luggage in the exterior storage compartment and close it securely.

Appliances

If your vehicle is equipped with a television, or other appliance, be sure they are compatible with your vehicle's electrical system. Secure them in the cab so they cannot come loose in a sudden stop.

**WARNING**

In a sudden stop or collision a heavy object in your cab could strike you or anyone with you. You could be injured or even killed. Secure any appliance

(such as a radio, or TV) you add to your sleeper or cab.

Vehicle Telematic System

Your vehicle may be equipped with an onboard telematics system. This system is a Global Positioning Satellite (GPS)-linked computer. It receives input from multiple sources to locate your vehicle. Read and understand the Supplemental Telematics and Navigation System Owner's Manual and observe the Warnings, Cautions, and Notes that follow before using the system.

**WARNING**

Verify legal weight and height restrictions for the route suggested by the telematic system. Failure to verify height restrictions could lead to causing death, personal injury or property damage. Failure to verify weight restrictions could result in a traffic infraction.

**WARNING**

Only glance at the system monitor while driving. Prolonged periods of viewing while driving could result in an accident involving death or personal injury.

**WARNING**

Do not program the telematic system while driving. Always stop your vehicle when programming or changing the settings on the telematic system. Programming the system while driving can cause you to take your eyes off the road, which could result in an accident involving death, personal injury or equipment damage.



WARNING

Regardless of how and where the navigation system directs you, it is your responsibility to operate the vehicle in a safe and legal manner. Failure to comply may result in death, personal injury, equipment or property damage.



WARNING

Ensure the volume level of all audio devices is set to a level that still allows you to hear outside traffic and emergency vehicles. Failure to comply may result in death, personal injury, equipment or property damage.



CAUTION

DO NOT rely on the telematic system to route you to the closest emergency services. Not all emergency services are in the database.



NOTE

The map database is the most current available at the time of production. The database is designed to provide you with route suggestions and does not take into account the relative safety of a suggested route or of factors that may affect the time required to reach your destination. See the Supplemental Navigation System Owner's Manual for more information.

Related concepts

Related tasks

Using the Telematic System

How to properly use the telematic system.

Screen Display On/Off

1. Press and hold the POWER/LIGHT button for approximately 1 second.
2. After the display has been turned on, the following Warning/Informational screen will appear.

Warning/Informational Screen

WARNING



Do not let this device distract you while driving. Always concentrate on your driving. Distractions could cause an accident resulting in injuries to you or others.

IMPORTANT

WARNING

Do not let this device distract you while driving. Always concentrate on your driving. Distractions could cause an accident resulting in injuries to you or others.

Disclaimer: Map data may be inaccurate and navigation routes may not be available for larger size vehicles. Regardless of how and where the navigation system directs you, it is your responsibility to operate the vehicle in a safe and legal manner. **Note:** Before using this system, read the Owner's Manual and learn how it operates. Some functions of this system will not operate when the truck is moving.

Warning/Informational Screen: Do not let this device distract you while driving. Always concentrate on you

3. After reading the information, touch the "T" in the upper right corner of the screen with your finger indicating you acknowledge and understand the information. The MENU screen will automatically appear next.
4. To turn the system off, press and hold the POWER/LIGHT button for 3 seconds.

Disclaimer: The vehicle manufacturer is not responsible for erroneous map data, misrouting or any downtime or other damages associated with or arising out of the use of the Navigation System.

Passenger Side 'down' Mirror

General information on using the passenger side 'down' mirror.

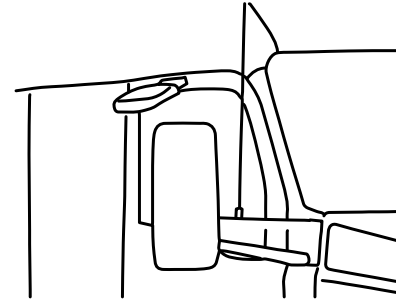

A mirror is located above the passenger door that provides a quick view of the blind spot created by the passenger door.

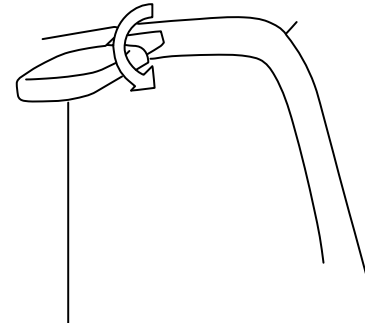

Rotate the mirror up or down to get the desired view.

Sleeper Control Panel

Vehicles with optional sleeper units will have a control panel next to the bunk to operate various functions from the comfort of the sleeper bed.

Sleeper Control Panel

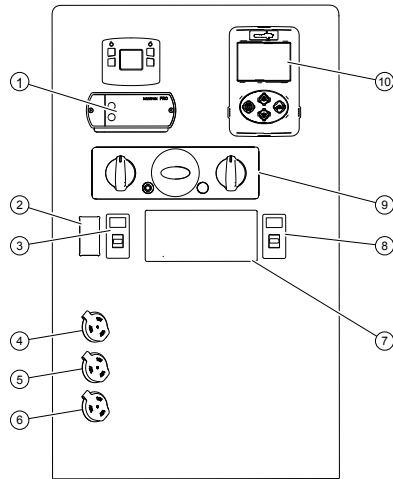

1. Inverter Control Module (Depending on options selected)

2. Point Light Switch (Depending on options selected)
3. Cab Door Lock Switch
4. 12V Power Port OR Cigarette Lighter (Depending on options selected)
5. 12V Power Port
6. 12V Power Port OR USB Charging Port (Depending on options selected)
7. Digital Alarm Clock OR Digital Alarm Clock with Sleeper Audio Controls (Depending on options selected)
8. Dome Light Switch
9. HVAC Controls
10. SmartAir/Fuel Fired Heater Controls (Depending on options selected)

truck's exterior lights will start flashing and the city horn will sound when this switch is pressed.

Optional alert switch not shown.

What is the Alert Switch?

Alert Switch



The alert switch is an optional switch mounted in the sleeper control panel. The

Chapter 4 | DRIVING

In this Chapter:

Starting and Operating.....	129
Starting and Warming Up.....	129
Engine Operations.....	133
Transmission.....	141
Brakes.....	146
Axle and Suspension.....	156
Aftertreatment System.....	164
Driving Tips and Techniques.....	165
What to Consider when using a Sleeper Bunk.....	168
Stopping the Vehicle.....	169

Starting and Operating

Since each vehicle is custom-equipped, all engine operation instructions in this manual are general. You will want to consult the manual for your engine to find out details about your specific engine's needs. You may need to use a slightly different procedure from the one outlined here.

Starting and Warming Up

How to Start Vehicle in Normal Weather



CAUTION

Never operate the starter motor while the engine is running. The starter and flywheel gears could clash or jam, severely damaging them.



NOTE

Some starters are equipped with over-crank protection. Check the Engine Operation and Maintenance Manual for details.

When the outside temperature is above 50°F (10°C), you can use the following procedure:

1. Set the parking brake.
2. Put your main transmission in Neutral.
3. Disengage (depress) the clutch (with manual transmission).
4. Turn the key switch to ON.
 - a. If the center display prompts for a Anti-Theft passcode, use the Menu Control Switch to enter the four digit code.
5. Turn the ignition key to the START position. If the engine does not start within 30 seconds, release the ignition switch. To avoid overtaxing the starter motor or the batteries, don't use the starter for more than 30 seconds. Let the starter motor cool and the batteries recover for

two minutes before trying again. If the engine still won't start after a couple of tries, check the fuel lines for possible fuel starvation or air leaks. Starting failure may mean fuel isn't reaching the injectors.

6. As soon as the engine starts, begin to watch the oil pressure gauge. Check your engine manufacturer's manual for the right pressure for your engine. If the oil pressure doesn't rise within a few seconds, stop the engine. Find out what is wrong before restarting the engine.
7. Slowly engage (release) the clutch after the engine has started.
8. Wait for the oil pressure gauge to reach normal operating pressure before operating the vehicle or idling faster than 1,000 rpm.

Anti-Theft (Optional)

Certain vehicles have functionality to require an operator to enter a 4 digit code to start the vehicle.

If the wrong code is entered, the display will show a lock icon. The unlock icon will appear once the correct code is entered and the operator will have up to 6 minutes

to turn the ignition on. If the engine is not started within the 6 minute timeframe, the operator will have to re-enter the passcode to start the engine.

Tips to Remember When Starting Vehicle in Cold Weather

In cold weather, fast engine starting helps relieve the loads on the electrical system and cranking motor. Using the special cold starting equipment will help starting.

If you follow a few simple guidelines, you will extend the service life of your engine:

- Keep the electrical system in top condition.
- Use the best quality fuel of the recommended grade.
- Use recommended engine lubricating oil.
- For manual transmissions and auxiliary transmissions, leave the transmission in neutral and allow the transmission lubricating oil to warm up (approximately 3-5 minutes) before operating vehicle.

Engine Block Heater (Optional)

To preheat the engine before starting, plug the optional engine block heater into a

properly grounded AC electrical source. Do not start the engine with the heater plugged in.

WARNING

Engine block heaters can cause fires which may result in death, injury and/or property damage if not properly maintained and operated. Regularly inspect the engine block heater wiring and connector for damaged or frayed wires. Do not use the heater if there are any signs of problems. Contact your authorized dealer or the manufacturer of the heater if you are in need of repairs or information.

CAUTION

Always unplug heater before starting the engine. Damage to the cooling system could occur if the heater is not turned OFF (unplugged).

Depending on engine make, when the temperature falls below -10°F (-24°C), the block heater is required.

Engine, Under Hood Air Intake

This switch opens a door in the engine air filter housing so that the air is taken from under the hood instead of outside air. This switch can be useful when starting the vehicle in cold weather conditions.



CAUTION

Only operate the under hood intake air switch when outside temperatures are below 32° F (0° C). Engaging the under hood air intake while temperatures are above freezing may result in engine damage.

Engine Warm Up

The purpose of engine warm-up is to allow oil film to be established between pistons and liners, shafts and bearings while your engine gradually reaches operating temperature.

1. After you've started your engine, idle it at approximately 600 rpm while you check:
 - a. oil pressure
 - b. air pressure
 - c. alternator output
2. After a few minutes of idling at 600 rpm, increase your idle speed to 900 or 1,000 rpm. Continue your warm-up. This procedure allows oil to warm and flow freely while pistons, liners, shafts, and bearings expand slowly and evenly. In extremely cold temperatures, you may have to increase idle speed.
3. Continue the engine warm-up until the coolant temperature reaches at least 130°F (54°C). At this temperature, you can use partial throttle. Wait until the coolant temperature is at least 160°F (71°C) before operating at full throttle.
 - a. Under most circumstances, idling your engine for long periods merely wastes fuel. In severe arctic weather conditions, however, you may need longer idling to be sure all parts of your engine are fully lubricated.

**NOTE**

In colder climates where the temperature is often below freezing, the warm-up for turbocharged engines is especially important. Chilled external oil lines leading to the turbocharger will slow the oil flow until the oil warms, reducing oil available for the bearings. Watch the engine oil temperature or pressure gauge for a warming trend before increasing engine idle speed (rpm).

**WARNING**

Exhaust fumes from the engine contain carbon monoxide, a colorless and odorless gas. Do not breathe the engine exhaust gas. A poorly maintained, damaged or corroded exhaust system can allow carbon monoxide to enter the cab. Entry of carbon monoxide into the cab is also possible from other vehicles nearby. Failure to properly maintain your vehicle could cause carbon

monoxide to enter the cab, resulting in death or personal injury.

**WARNING**

Never idle your vehicle for prolonged periods of time if you sense that exhaust fumes are entering the cab. Investigate the cause of the fumes and correct it as soon as possible. If the vehicle must be driven under these conditions, drive only with the windows open. Failure to repair the source of the exhaust fumes may result in death, personal injury, equipment or property damage.



WARNING

To reduce the chance of personal injury, vehicle damage and/or death from overheated engines, which can result in a fire, never leave the engine idling without an alert driver present. If the engine should overheat, as indicated by the engine coolant temperature light, immediate action is required to correct the condition. Continued unattended operation of the engine, even for a short time, may result in serious engine damage or a fire. Failure to comply may result in death, personal injury, equipment or property damage.



CAUTION

The use of a winterfront can result in excessive engine coolant, oil, and charge air (intake) temperatures, which can lead to overheating and possible engine damage.



CAUTION

DO NOT allow your engine to idle, at low rpm's (400-600 rpm), longer than five minutes. Long periods of idling after the engine has reached operating temperatures can decrease engine temperature and cause gummed piston rings, clogged injectors, and possible engine damage from lack of lubrication. The normal torsional vibrations generated can also cause transmission wear.



NOTE

Keep the engine exhaust system and the vehicles cab ventilation system properly maintained. It is recommended that the vehicles exhaust system and cab be inspected (1) By a competent technician every 15,000 miles (24,140 km) (2) Whenever a change is noticed in the sound of the exhaust system (3) Whenever the exhaust system, underbody, or cab is damaged.



NOTE

If you are parked next to idling vehicles, move your vehicle or do not stay in your vehicle for prolonged periods of time.

How to Warm Up the Transmission

In cold weather (below 32°F (0°C), you may find shifting sluggish when you first start up. Transmission warm-up is especially important at this time, but it is always a good idea to warm-up your transmission before starting out on the road.

To warm-up the transmission lubricating oil during engine warm-up, with a single transmission (manual and automatic):

1. Put the transmission in Neutral.
2. Release the clutch pedal (manual only) and operate the transmission in neutral for 3 to 5 minutes prior to operating the transmission in either forward or reverse range.
3. If you have a two-transmission combination:
 - a. Put the main transmission in gear.

- b. Put the auxiliary transmission in Neutral. This will allow the transmission countershaft to turn, agitating the oil and warming it.

Cancel the PTO operation by canceling the engine rpm set speed. This can be done by tapping the brake or clutch pedal or by using the cruise control switches.

Related concepts

Related tasks

Engine Operations

Stationary Power Take Off Operation

The cruise control buttons for this vehicle may be used to control the engine rpm when the vehicle is stationary and the operator wants to use the Power Take Off (PTO) on the engine. Use the cruise control options in the same manner as with the vehicle in motion, but instead of setting vehicle speed, the engine speed (rpm) is set instead.

1. Ensure parking brakes are applied.
2. Ensure transmission is in Neutral.
3. Engage PTO per the manufacturer's operating instructions.
4. Move the **ON/OFF** switch to the **ON** position.
5. Toggle the **SET/RESUME** switch to obtain the desired engine rpm.

Engine Fan Control

Important guidelines to using the engine fan control.

The engine fan switch on the dash has a manual and an automatic mode. In the manual mode, the engine fan will engage until the switch is back into automatic mode. In automatic mode, the engine fan operation is controlled by the engine computer.



WARNING

Do not work on or near the fan with the engine running. Anyone near the engine fan when it turns on could be injured. If it is set at MANUAL, the fan will turn on any time the ignition key switch is turned to the ON position. In AUTO, it could engage suddenly without warning. Before turning on the ignition or switching from AUTO to MAN-

UAL, be sure no workers are near the fan. Failure to comply may result in death or personal injury.



CAUTION

DO NOT operate the engine fan in the MANUAL position for extended periods of time. The fan hub was designed for intermittent operation. Sustained operation will shorten the fan hub's service life as well as reduce fuel economy.



CAUTION

The fan or equipment near it could be damaged if the fan turns on suddenly when you do not expect it. Keep all tools and equipment away from the fan.

Using a Winterfront

A winterfront or other air flow restriction device may be mounted in front of the

radiator to increase cab heater temperature in cold climates.



CAUTION

The use of a winterfront can result in excessive engine coolant, oil, and charge air (intake) temperatures, which can lead to overheating and possible engine damage.



CAUTION

A winterfront should only be used at temperatures below 40°F (4°C). Use of a winterfront above 40°F (4°C) can decrease life of cooling module components. Remove winterfront as soon as the ambient temp reaches 41°F (5°C). The use of a winterfront above 40°F (4°C) can result in excessive engine coolant, oil, and charge air (intake) temperatures, which can lead to overheating and possible engine or coolant module damage and emissions non-compliance.

The winterfront is designed to minimize the temperature differences across the radiator

and reduce the possibility of cooling module damage. Aftermarket winterfronts may not provide the proper airflow distribution and could cause cooling module damage.

Engine Control Display

Your vehicle may come with an optional Engine and Driver Information Display. This instrument records information on engine diagnostics, scheduled maintenance, driving conditions, and general trip information. The specific features of your display may vary depending on engine make.

What is Exhaust Aftertreatment

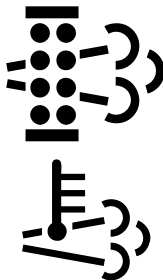

Vehicles manufactured with diesel engines have an exhaust Aftertreatment System (ATS) to control vehicle exhaust emissions. The system consists of a Diesel Particulate Filter (DPF), Selective Catalyst Reduction (SCR), Regeneration Switch and warning lights. The DPF will trap soot from the engine exhaust gases. The SCR uses Diesel Exhaust Fluid to reduce the levels of NOx in the engine exhaust. The ATS will periodically clean (regenerate) the DPF. Please refer to the Exhaust Aftertreatment System Supplement provided with the vehicle for more detailed description of functionality and warnings.

Engine Brake Operation

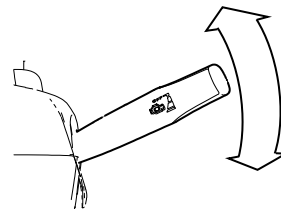

Moving the lever clockwise will engage the engine brake. Increase the amount of engine brake by moving the lever further clockwise. Each position has a corresponding level of engine brake.

Position	Amount of Engine Brake
Off	0 %
1	33%
2	66%
3	100%

Engine Brake Operation for a Vehicle with Automated Transmission

Moving the lever clockwise will engage the engine brake. Increase the amount of engine brake by moving the lever further clockwise. Each position has a corresponding level of engine brake.

Position	Amount of Engine Brake
Off	0 %
1	33%
2	66%
3	100%

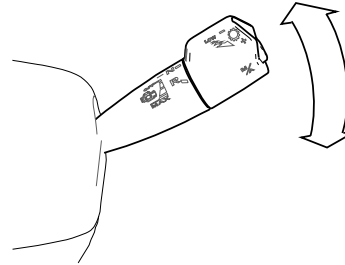

Position	Amount of Engine Brake
4*	100% AND will engage transmission low gear
	* This position is momentary and will revert back to position 3 when the lever is released.

The corresponding engine brake level (or MAX mode) will be illuminated in the instrument cluster.

Related tasks

Cruise Control

This vehicle has cruise control. Cruise control functions and features may vary depending upon which engine you have. For specific explanation of your cruise control, see the cruise control or engine manual included with your vehicle.

This vehicles electronic system will perform a 'rationality check' every time the vehicle is started. This check is to ensure that the service brakes are working before allowing cruise control to function. This safety feature is designed to ensure that a driver is able to cancel the cruise set speed by using the service brake pedal. The system will not allow cruise control operation if it

does not pass the 'rationality check.' The instrument cluster will prompt you to press the service brake pedal if it has not been pressed since the vehicle has been started. In vehicles with Eaton transmissions, the cruise control switches may be located on the shift control knob.

How to Use Set Cruise Control Speed When Driving

Information on using the cruise control.

This vehicle may have cruise control switches located on the steering wheel instead of the switches on the dash board. The instructions are still the same. these instructions do not apply to Adaptive Cruise Control. While the buttons are also used to control PTO operations, these instructions are specifically for vehicle speed. The vehicle speed must be greater than 19 mph (30 kph) for PACCAR powered vehicles or 30 mph (49 kph) for Cummins powered vehicles and the engine speed must be over 1,100 rpm for the cruise set speed to work.

To Set the Cruise Speed

1. Turn the cruise function on by using the ON/OFF button
The cruise icon will appear in the instrument panel display.



2. Accelerate the vehicle via accelerator pedal to the desired cruise speed.
3. Press the "SET" button to set the cruise speed.



NOTE

Cruise Control may not hold the set speed going down hills. If the speed increases going down a hill, use the brakes to slow down. This will cancel Cruise Control.

The cruise set speed will appear in the instrument panel display.

How to Change Cruise Set Speed

Once the cruise set speed is set, the operator can push certain buttons to increase or decrease speed.

The vehicle cruise control must be on and the cruise speed engaged.

1. To increase speed:

- Press the + button on the Right Steering wheel pod if available.
 - Press the SET portion of the SET/RESUME button on the dash
2. To decrease speed:
 - Press the - button on the Right Steering wheel pod if available.
 - Press the RESUME portion of the SET/RESUME button on the dash

Canceling and Resuming Cruise Control

At times the operator will need to override cruise control and take over.

There are three ways to cancel the set speed in cruise control:

1. Tap the brake pedal
2. Tap the clutch pedal
3. Turn the cruise control system off (ON/OFF button on steering wheel or the CANCEL button on the dash)

Using the brake or clutch pedal to cancel set speed allows the operator to use the RESUME feature. Pressing the RESUME button will resume the vehicle speed previously set.

When turning the system off, the previous set speed is removed from memory. The operator will have to manually reset the cruise speed.

Adaptive Cruise Control (Optional)

This vehicle may be equipped with an Adaptive Cruise Control system that enhances the standard cruise control function. Consult your Adaptive Cruise Control operator's manual for detailed limitations.



WARNING

The Adaptive Cruise Control system in this vehicle is not autonomous and requires human interaction. The driver must always remain alert and ultimately is the one still responsible for safe vehicle control. The driver must monitor the driving environment and be ready to intervene at any moment. Failure to comply may result in death, personal injury, equipment or property damage.

Adaptive Cruise Control uses a radar sensor or camera to detect objects in front of the vehicle. The system will adjust the

speed of the vehicle to accommodate a slower moving object in front of it. The driver has the option of setting the adjustment to either (1) maintain a certain distance from the object in front or (2) maintain a speed of the forward object. The Driver Information Display will have the following icons in the display related to Adaptive Cruise Control.

Standard Adaptive Cruise Control Icons



Adaptive Cruise Control with Lane Departure Icons



Both standard Adaptive Cruise Control and Adaptive with Lane Departure will show the distance to the object in front (measured in seconds) to the left of the vehicle icon. The

cruise control set speed is shown on the bottom of the display. Vehicles with Lane Departure feature also has a number inside the car icon.



This number represents the speed of the car in front of your vehicle.

Adaptive Cruise Control Alerts

The Driver Information Display will alert the driver with visual and audible cues. A slow beep indicates that something is in the vehicle's path. As the object gets closer, the frequency of the beep increases. The audible beeps can be temporarily muted using the dash switch with this icon. It will automatically be unmuted after 15

minutes.



Level 3 (Green) Following Distance Alert

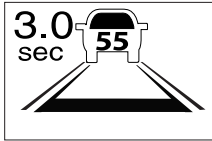

Level 2 (Yellow) Following Distance Alert

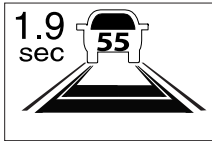

This warning is active when the following distance is less than what is set in the system. This warning is more severe than the Level 3 Following Distance Alert.

Level 1 (Red) Following Distance Alert

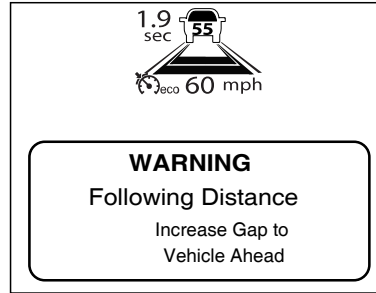

This warning is active when the following distance is less than what is set in the system. This warning tone is the most severe following distance alert.

Brake Command Warning

Collision Alert

The system first displays the **Collision Alert** so that the driver can address the situation without the system using foundation brakes. If the brakes are not engaged by the driver, the system will attempt to slow the vehicle by applying the brakes to assist the driver in reducing the severity of or potentially avoiding a

collision. At this point, the information display will change from **Collision Alert** to **Collision Alert BRAKE!**

The warning is active when the driver must take immediate evasive action by applying more braking power and/or steering clear of the vehicle ahead to avoid a potential collision.



The system can also detect stationary objects in the vehicles path. The operator needs to take control of the vehicle to avoid the stationary object. The icon will be accompanied with a pop-up message but no audible sound.

Active Cruise and Braking (ACB) Fault Alert



This warning is presented to alert the operator that the Adaptive Cruise system is malfunctioning and will be disabled. The operator will need to resume control of the vehicle's throttle and brakes. The system

will remain disabled until the fault is corrected.

Additional Features



Vehicles with optional lane departure warning will have the ability to highlight the left and right side of the 'lane' in the display area. The system will alert the driver if a lane is being crossed when

- The system is turned on via dash mounted switch
- The lanes are recognized (white with black outline)
- The vehicle is moving
- The turn signals are not in use

NOTE

The lanes will be black with a white outline if the system does not detect a lane marker. The system needs to detect both lane markers on either side of the vehicle to operate.



Vehicles with lane departure feature will also have the ability to recognize traffic signs for speed limits (both US and Canada).

NOTE

The system needs to scan 3 signs if the truck is switching between US and Canadian roads.



Blue and red markers on top of the speed sign will light up and alternate when the system detects that it is traveling faster than the posted speed limit.

Predictive Cruise Control (Optional)

Predictive Cruise Control (PCC) is a cruise control option that uses satellite technology and GPS maps to look at upcoming roads to dynamically calculate the optimal fuel efficient vehicle speed over a given terrain.

Predictive Cruise Control operates similarly to Standard Cruise Control. With PCC, you can maintain a vehicle speed without holding your foot on the accelerator pedal and it is operative when the vehicle's speed is 19 mph (30 km/h) or more. The main difference between Standard Cruise Control and PCC, is that instead of maintaining a constant set speed, PCC will actively recalculate and change the set cruise control speed within a predefined range for best fuel economy. For maximum fuel economy and safety, your PCC system was optimized to work with the Adaptive Cruise Control System (if equipped). Vehicles with the predictive cruise control option will see this graphic on their cruise control switches.



Operation of predictive cruise control is the same as with normal cruise control buttons. The only difference to the operator is how the vehicle accelerates and coasts in order to maintain speed while optimizing fuel economy.

PCC Behavior

As the vehicle approaches the top of a hill, PCC will decrease the vehicle speed to avoid overshooting the set-speed, in order to avoid unnecessary acceleration on the downward slope. This will result in a smoother, more fuel efficient ride to the top. Once over the crest, momentum takes over and the system will allow a predetermined amount of speed over the set-speed.

If the driver has activated the vehicle's Auto Retarder function, the vehicle speed may increase until it reaches the set-speed. If the vehicle drops outside the speed range, normal cruise control will accelerate the vehicle back to the minimum allowable speed. If the vehicle is equipped with Adaptive Cruise Control (ACC) and senses traffic slowing, it will overrule PCC and slow the vehicle. This event will cancel PCC. To resume the set speed, press the "SET/RESUME" button. As the vehicle reaches flat ground after the hill, PCC will maintain the set-speed until the crest of the next hill. If you are in an area where there is no road data, the GPS signal is lost, or there is a system fault, the vehicle will revert to normal cruise control at the same cruise speed that was selected for PCC.

There are many factors that may influence or prevent a PCC event from occurring. For example, a truck (without a trailer) may encounter fewer PCC events than a truck with a trailer. If your vehicle has the Driver Performance Assistance (DPA) and you have not used PCC for a long period of time, the DPA may advise turning PCC ON to improve fuel economy. If the vehicle enters an area that is not identified in the system's map, it will revert to normal cruise control behavior until the vehicle enters known map areas.

If the system detects a problem with its software, its map, terrain, and vehicle position then it will display a fault to the operator. If a fault is detected, please seek the service of an authorized dealer.

If you need to access the system's software version, please use the menu control switch to navigate to the **TRUCK INFO > PCC >** within this menu you can find **PCC Soft Vers** and **PCC Map Vers**.

Air Filter Restriction Indicator

General information about the engine air filter restriction indicator.

An Air Filter Restriction Indicator is installed on the air cleaner or air induction piping so it has access to clean filtered air.

As the filter plugs and restriction increases, a red indicator will appear in a window on the indicator. When red appears, the air filter should be replaced. The indicator can be reset by pressing the button at the end of the indicator.

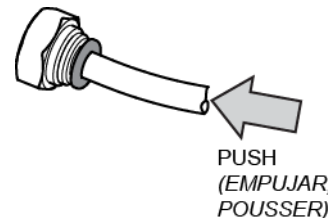
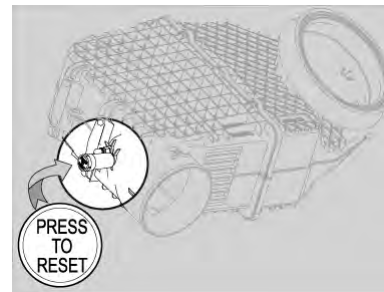

Transmission

Transmission Tips

General information on operating the transmission.

Riding the Clutch

The clutch is not a footrest. Do not drive with your foot resting on the clutch pedal. It will allow your clutch to slip, causing excessive heat and wear, damage could result.

Release Bearing Wear

When you must idle your engine for any period of time, shift your transmission to neutral and disengage the clutch (take your foot OFF of the pedal). This helps prevent unnecessary wear to your clutch release bearing, and it is less tiring for you, too.

More Tips

- Always use the clutch when making upshifts or downshifts.
- Always select a starting gear that will provide sufficient gear reduction for the load and terrain.

- Never downshift when the vehicle is moving too fast.
- Never slam or jerk the shift lever to complete gear engagement.
- Never coast with the transmission in neutral and the clutch disengaged. To provide smooth gear engagements while shifting, use proper coordination between shift lever and clutch.
- Double clutching is a very effective means to increase the service life of your transmission. Double clutching refers to a technique where the clutch pedal is used twice per shift instead of once. It also requires that you adjust the engine rpm in the middle of the shift which ultimately synchronizes the gears during shifting. Synchronizing reduces wear on the gears.

Related tasks

Operating Manual Transmissions

Follow these instructions if the vehicle has a manual transmission.

The transmission shift pattern for your vehicle may be located on the shift control

knob. In addition to understanding the shift pattern and its location, you should read the transmission manufacturer's manual provided with your vehicle before operating the vehicle. After making sure the vehicle's oil and air pressure are correct and all other parts and systems are in proper working condition:

1. For vehicles with a clutch pedal, locate the clutch pedal and engage the clutch brake.
2. Shift into a low gear.



CAUTION

Always use first gear or a low speed range to start the vehicle in motion. The use of a higher gear or speed range forces undue strain on the engine, clutch, other transmission components, and may cause damage.

3. Evaluate the road surface conditions and terrain your vehicle is on. Select a gear low enough to let your vehicle start forward with the throttle at idle.
4. Push the parking brake valve handle (Yellow) against the dash panel to release the brakes.

5. Release the clutch pedal (manual only), then gradually accelerate to permit smooth starting.
6. Do not allow your vehicle to roll (even a little) in the opposite direction during clutch engagement. If you need to start up on an incline, apply your service brakes before you release the parking brake. Then release your service brakes as you engage the clutch and apply throttle.

For further instructions on operating your transmission, see the transmission manufacturer's Driver/Operator's Instruction Manual.

If you want to shift directly into any gear other than first or reverse, depress the clutch pedal only far enough to release the clutch. Fully depressing the pedal applies the clutch brake and could cause gear hang-up.

If you have a misaligned gear condition in your vehicle's transmission and cannot start, gradually release the clutch, allowing the drive gear teeth to line up properly. Then the drive gear can roll enough to allow the teeth to line up properly and complete the shift. The best engine performance and maximum economy is obtained if gears are properly selected.

This efficiency is achieved by always selecting gears within optimum engine rpm, which is where maximum torque and power are obtained.

Shift carefully in a new vehicle. The transmission may be a little stiff at first. Avoid gear clashing, by closely following these procedures. When you are operating a new vehicle or one that has been exposed to cold weather, you want the transmission lubricant (fluid) to circulate and coat the contacting surfaces of the gears. Metal contacting metal in moving parts may seriously damage your transmission, do not drive in one gear for long periods of time until the transmission lubricant has a chance to coat all contacting surfaces.

- Always select a starting gear that will provide sufficient gear reduction for the load and terrain.
- Never downshift when the vehicle is moving too fast.
- Never slam or jerk the shift lever to complete gear engagement.
- Never coast with the transmission in neutral and the clutch disengaged.

How to Use the Hydraulic Clutch

Certain vehicles have a hydraulic clutch to shift a manual transmission.



CAUTION

Be careful not to apply the clutch brake while the vehicle is moving. The purpose of the clutch brake is to stop the transmission so that you can shift into a starting gear without grinding gears. Applying the clutch brake when the vehicle is moving causes a braking effect on the drivetrain and shortens the service life of the clutch brake.



CAUTION

Do not push the clutch pedal completely to the floor when shifting while the vehicle is in motion. Using the clutch brake while shifting a vehicle in motion will damage the clutch brake. A non functioning clutch brake will make shifting very difficult when the vehicle is stationary.

1. Depress the clutch pedal past the first 1/2 inch (13 mm) for

approximately 5 1/2 in (139.7 mm) of total pedal travel.

2. Depress the clutch pedal another 1/2 in (13 mm) to engage the clutch brake.

The clutch brake is used for stopping transmission gears, allowing you to easily shift into first gear or reverse without grinding gears. The clutch brake is not necessary when shifting into other gears while in motion.

If the clutch pedal is pressed completely to the floor and the transmission is not shifting, then it is time to have the clutch adjusted or serviced.

If the transmission has a butt-tooth condition and you cannot engage a gear, gradually release the clutch. Then the drive gear can roll enough to allow the teeth to line up properly and complete the shift. The clutch is not a footrest. Do not drive with your foot resting on the clutch pedal. It will allow your clutch to slip, causing excessive heat and wear, damage could result.

When you must idle your engine for any period of time, shift your transmission to neutral and disengage the clutch (take your foot OFF of the pedal). This helps prevent unnecessary wear to your clutch release bearing, and it is less tiring for you, too.

- Always use the clutch when making upshifts or downshifts.
- Never coast with the transmission in neutral and the clutch disengaged.
- To provide smooth gear engagements while shifting, use proper coordination between shift lever and clutch.

How to Shift using Double Clutch Method

Whether you are upshifting or downshifting, it is best to double clutch. Double clutching is easier on the transmission and on the engine, helping your vehicle match engine speed with driveline speed and achieving clash-free shifts.

To double clutch:

1. Push the clutch pedal down to disengage the clutch.
2. Move the gear shift lever to neutral.
3. Release the pedal to engage the clutch. This lets you control the rpm of the mainshaft gears, allowing you to match the rpm of the mainshaft gears to those of the output shaft.

- a. a. Upshifts: let the engine and gears slow down to the rpm required for the next gear.
 - b. b. Downshifts: press accelerator, increase engine and gear speed to the rpm required in the lower gear.
4. Now quickly press the pedal to disengage the clutch and move the gear shift lever to the next gear speed position.
 5. Release the pedal to engage the clutch.

Automatic and Automated Transmissions

An automatic or automated transmission makes shifting much easier. It remains important to completely understand how to operate the transmission to optimize its efficiency. Please read the manual for your automatic or automated transmission included with your vehicle.

For automated transmissions, there is no "park" position. So you will need to apply the parking brake before leaving the cab.

**WARNING**

If your vehicle has an automated transmission, be aware that it can roll backwards when stopped on a hill or grade, or when starting from a stop on a hill or grade. Failure to comply may result in death, personal injury, equipment or property damage. Observe the following guidelines: (1) When stopped on a hill or grade, press the brake pedal. (2) When starting from a stop on a hill or grade, quickly remove your foot from the brake pedal and firmly press on the accelerator pedal.

**WARNING**

Do not leave the cab of your vehicle without applying the parking brake. The truck could roll and cause an accident resulting in death or personal injury. Always apply the parking brake before you leave the cab.

Hill Hold

The hill hold feature is available as an option with certain automated transmissions. This feature holds the vehicle while on a hill to allow the operator to release the service brakes and press the accelerator. This feature will hold the vehicle if the vehicle is attempting to go up a hill from a stop in either drive or reverse.

Controls for Vehicles with an Eaton Automated or a PACCAR Transmission

This vehicle may be equipped with either an Eaton Automated or a PACCAR Transmission. The Automated or PACCAR Transmission controls are located on the right hand side of the steering column.

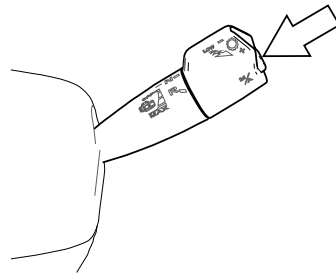
Using the Manual - Automatic Button

This button will put the transmission into manual mode. Manual mode will allow the operator to select the gear. See [Up or Down Shifting](#) on page 145.

To activate, put the gear selector in the **D** (drive) mode and then depress the **M/A** button. The instrument cluster will display the corresponding selection.

For Peterbilt Vehicles

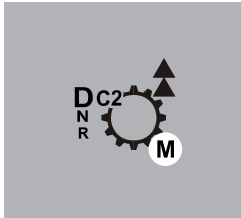

How to Deactivate MAX Mode

Vehicles with automated transmissions will have the engine brake function integrated with the transmission controls. Follow these steps to deactivate **MAX** engine brake mode.

1. Accelerate with the throttle pedal.
2. Upshift, see [Up or Down Shifting](#) on page 145.
3. Wait for the transmission coast down gear to engage.
4. Reduce engine brake level, see [Engine Brake Operation for a Vehicle with Automated Transmission](#) on page 135.

5. Re-initiate **MAX** mode, see [Engine Brake Operation for a Vehicle with Automated Transmission](#) on page 135.
6. Select Neutral **N**, see [Drive Neutral Reverse Selector](#) on page 146.
7. Select **LOW** mode, see [Engine Brake Operation for a Vehicle with Automated Transmission](#) on page 135.

Pushing the lever forward will down shift. Pushing and holding the lever forward will engage the LOW gear range. Pulling the lever towards the driver will upshift the transmission. Some vehicles may have a feature that prompts the operator to shift for optimal fuel economy.

For Peterbilt Vehicles with Shift Assist

Up or Down Shifting

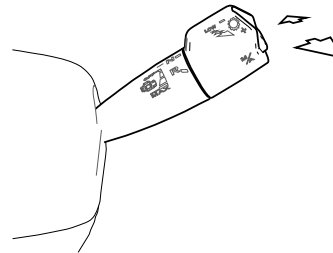

When in the Manual mode, the transmission gears can be manually selected by pushing or pulling on the lever.

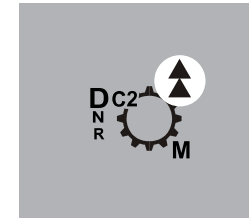

If the prompt appears in the instrument cluster, use the manual gear selector lever to change gears.

The instrument cluster will illuminate with the corresponding gear.



Drive Neutral Reverse Selector

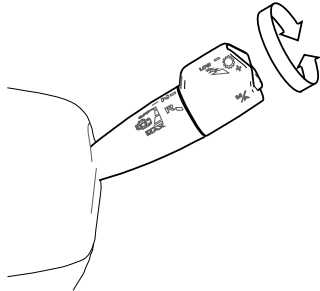

Transmission mode is selected by rotating the lever's outer knob. There is a detent for **Drive, Neutral, Reverse**. The instrument cluster will display the corresponding mode. For Peterbilt Vehicles

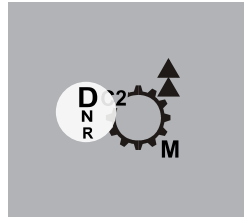

NOTE

Selector (the transmission) must be in **N** (Neutral) to start the truck.

Auxiliary Transmission

Information about using the auxiliary transmission.

If you have an auxiliary transmission, see your transmission manufacturer's manual for its proper operation.

Brakes

Air Brake System

This vehicle's brake system functions with the use of compressed air generated from the engine's air compressor. The compressed air is stored in various air tanks to ensure that air pressure is available whenever the driver needs it.



WARNING

Do not drive through water deep enough to wet brake components, as it may cause the brakes to work less efficiently than normal. The vehicle's stopping distance may be longer than expected, and the vehicle may pull to the left or right when brakes are applied, which could contribute to an accident involving death or personal injury.

Compressed air is delivered to the brake system through the valve at the brake pedal and is controlled with various valves and braking circuits. The brake system is designed with separate front, rear and (when applicable) trailer circuits so that if one circuit is compromised and loses air, the other circuits will not be affected. Safety valves in each circuit will protect the other circuits in the event that a circuit loses air.

The air compressor on the engine will typically provide 100-130 psi (690-896 kPa) to the air tanks. The vehicle is also designed with an air dryer, which removes moisture from the compressed air in order to protect all components in the air system. The brake system may be further enhanced by additional devices such as brake proportioning valves, Anti-lock braking systems or sensors designed to let you know if your brake pads need to be serviced. Certain conditions may result in the brake surfaces getting wet. Brake surfaces that are wet do not perform as well as when they are dry. There may be situations where wet brake surfaces cannot be avoided. In such situations, apply the brakes while in motion, to dry the brake surfaces.

Certain conditions may result in your brake surfaces becoming overheated (above 800°F or 427°C). Overheated brakes will damage linings and drum surfaces, ultimately decreasing braking performance. Refer to Retarders and Descending a grade to avoid overheating the brakes.

Parking Brake

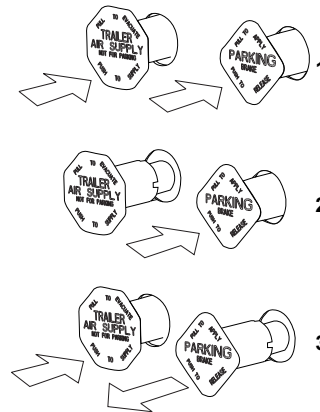

1. Normal Run Position
2. Trailer Park with Vehicle Released
3. System Park or Trailer Charge with Vehicle Parked

Parking brakes work in reverse action of the regular brakes. When the parking brakes are engaged, air is exhausted from the spring chambers, which allows the spring to engage the brakes. This design also provides a safety function if a brake circuit has a leak and loses air. In such a scenario, the parking brakes will apply. The vehicle's parking brake controls are the yellow diamond shaped knob on your dash board. If the vehicle is equipped to tow a trailer, then there will be an additional red octagon shaped knob for the trailer parking brakes. Parking brakes will be engaged when either of these knobs are pulled OUT. (If one knob is pulled out, the other knob will automatically pop out.) Pushing IN a knob will disengage the respective parking brakes. If you push in the yellow knob only, you will disengage the vehicle's parking brakes but will not disengage the trailer parking brakes (if applicable). Either knob will pop back out if the system pressure is not above 60 psi (414 kPa). The instrument panel display will provide a message any time the parking brakes (vehicle or the trailer) are set and the vehicle is put into motion.

Engage Trailer Hand Brakes

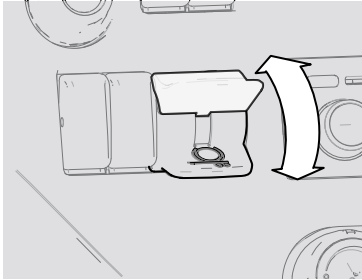

Press the lever down to engage the Trailer Hand Brakes. Push the lever back up to release the Trailer Hand Brakes.

Automatic Traction Control

General information on ABS and automatic traction control.



Your truck/tractor ABS is equipped with an automatic traction control (ATC) feature. This feature is controlled by a switch on the dash. Do not allow the traction control lamp to remain on continuously for an extended length of time. Extended continuous use of

the ATC can cause overheating of the drive wheel brakes. Engine torque or vehicle speed should be reduced to eliminate wheel spin and prevent excessive application of the ATC system. Except for checking for proper illumination of the ABS and traction control warning lamps when first starting the vehicle, and for monitoring these lamps while driving, no special operating procedures are required. For detailed system description, see literature for your specific ABS that was provided with your vehicle.

Anti-Lock Brake Systems (ABS)

Information on using the anti-lock brake system.

This vehicle may be equipped with an anti-lock braking system (ABS). This ABS reduces the possibility of wheel lock-up. If a wheel is about to lock during braking, the ABS will automatically adjust air pressure to the brake chambers on the appropriate wheel(s) to prevent wheel lock-up. The ABS is automatically turned on when the ignition switch is turned on.



WARNING

The Anti-Lock Brake System is a critical vehicle safety system. For the safety of you and others around you, have the vehicle submitted for periodic preventive maintenance checks as well as having any suspected problems immediately checked by an authorized dealer. Failure to properly maintain your brake system can lead to serious accidents. Failure to comply may result in death, personal injury, equipment or property damage.

**WARNING**

Do not rely on an anti-lock brake system that is functioning improperly. You could lose control of the vehicle resulting in a severe accident, causing death or personal injury. If your ABS lamp goes on while you are driving or stays on after the self-check, your anti-lock system might not be working. The ABS may not function in an emergency. You will still have conventional brakes, but not anti-lock brakes. If the lamp indicates a problem, have the ABS checked.

Vehicles without anti-lock brake systems (ABS) are typically equipped with a bobtail brake proportioning system. When a trailer is not connected, the drive axle brake application pressure will automatically be limited by the proportioning system. When driven in a bobtail mode, these tractors will require greater brake pedal application to provide the equivalent braking to a bobtail tractor not equipped with a proportioning system.

Trailer ABS Power Line Communication (PLC)

North American on-highway vehicles are equipped with a separate electrical circuit to power the anti-lock brake system (ABS) on towed vehicle(s). In most cases, the ABS power will be supplied through the Auxiliary circuit on the primary 7-way trailer light line connector. If the vehicle was manufactured with a switchable Auxiliary circuit for trailer accessories, an additional 7-way connector would have been provided for trailer ABS power. In either case, the ABS power line on the vehicle will be PLC equipped.

**CAUTION**

DO NOT splice into the non-switchable Auxiliary circuit on the primary 7-way trailer light line. Doing so may cause the trailer ABS to malfunction. This circuit is dedicated for trailer ABS power. To add a switchable auxiliary circuit, contact a dealership.

**NOTE**

Tractors/Trucks and trailers built after 03/01/2001 must be able to turn on an In-Cab Trailer ABS Warning Lamp (per U.S. FMVSS121). The industry chose Power Line Communication (PLC) as the standard method to turn it on. On trailers built prior to 03/01/2001 verify trailer ABS system status via the required external warning lamp mounted on the trailer. The indicator lamp on the trailer should be yellow and identified with the letters ABS.

For doubles or triples, the lamp does not distinguish between trailers. An ABS problem in any of the trailers will activate the Trailer ABS Warning Lamp. If you change the intended service in any way (e.g., number of axles, multiple trailers, add switchable trailer accessories, etc.) from the date the vehicle was manufactured, you should contact your trailer manufacturer and/or trailer anti-lock brake manufacturer to determine if the power available at the 7-way trailer light line is adequate. Failure to do so might result in insufficient power to the trailer

ABS system, which may affect its operation.



CAUTION

The center pin of the 7-way trailer light line may be constantly powered for ABS. Make sure it will not accidentally turn on trailer equipment.



NOTE

Very few trailers built before 03/01/2001 have this option. Trailers built after 03/01/2001 are built with PLC technology.

the system will intervene to assist the driver.



ESC may reduce the vehicle speed automatically. To minimize unexpected deceleration and reduce the risk of a collision the operator must:

- Avoid aggressive driving maneuvers, such as sharp turns or abrupt lane changes at high speeds, which might trigger the stability system.
- Always operate the vehicle safely, drive defensively, anticipate obstacles and pay attention to road, weather, and traffic conditions. ABS, ATC, and ESC stability systems are no substitute for prudent, careful driving.

Roll Stability Program

Bendix® Roll Stability Program (RSP), an element of the overall ESC system, addresses rollover conditions. In the case of a potential roll event, the ECU will override the throttle and quickly apply

Advanced ABS with Stability Control

What you need to know about your vehicle's braking, traction, and stability control features.

Electronic Stability Control is a feature that reduces the risk of rollovers, jackknifing, and other loss of control situations. ESC features include Roll Stability Program (RSP) and Yaw Control.

During operation, the ECU of the Bendix® Advanced ABS system constantly compares performance models to the vehicle's actual movement, using the wheel speed sensors of the ABS system, as well as lateral, yaw, and steering angle sensors. If the vehicle shows a tendency to leave an appropriate travel path, or if critical threshold values are approached,

Special Trailer ABS (Without PLC) Option

If a trailer does not have PLC, but it does have ABS that is powered through an optional second trailer connector (ISO 3731) and that trailer ABS is designed to control the Trailer ABS Warning Lamp in the cab and the vehicle has been ordered with the option to turn on this lamp for these types of trailers, then this lamp will turn on when that trailer ABS has a system problem. This should be checked by a dealer as soon as possible. The Trailer ABS Warning Lamp will not turn on for the power-on test when connected to these types of trailers.

brake pressure at all wheel ends to slow the vehicle combination. The level of braking application during an RSP event will be proportional to roll risk.

A Real World Example of How the RSP System Operates

Excessive speed for road conditions creates forces that exceed the threshold at which a vehicle is likely to rollover on a higher-friction surface. The system automatically reduces engine torque and applies the service brakes (based on the projected rollover risk) to reduce the vehicle speed, thereby reducing the tendency to roll over.

RSP Example

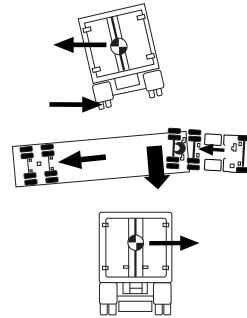

Yaw Stability

Yaw stability counteracts the tendency of a vehicle to spin about its vertical axis. During operation, if the friction between the road surface and the tires is not sufficient to oppose lateral (side) forces, one or more of the tires can slide, causing the truck/tractor to spin. These yaw events are referred to as either "under-steer" (where there is a lack of vehicle response to steering input due to tire slide on the steer axle) or "over-steer" (where the tractor's rear end slides out due to tire slide on the rear axle) situation. Generally, shorter wheelbase vehicles (tractors, for instance)

have less natural yaw stability, while longer wheelbase vehicles (straight trucks, for instance) have greater natural yaw stability. Factors that influence yaw stability are: wheelbase, suspension, steering geometry, weight distribution front to rear, and vehicle track width.

Yaw Control

Yaw Control responds to a wide range of low- to high-friction surface scenarios including rollover, jackknife and loss of control. In the case of vehicle slide (over-steer or under-steer situations), the system will reduce the throttle and then brake one or more of the "four corners" of the vehicle (in addition to potentially applying the trailer brakes), thus applying a counterforce to better align the vehicle with an appropriate path of travel. For example, in an over-steer situation, the system applies the "outside" front brake; while in an under-steer condition, the "inside" rear brake is applied.

A Real World Example of How Yaw Control Operates

Excessive speed exceeds the threshold, creating a situation where a vehicle is likely to spin and jackknife. The Bendix® Yaw Control system reduces engine throttle and

selectively applies brakes to reduce the vehicle speed, thereby reducing the tendency to jackknife.

Yaw Control Example

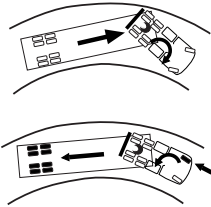

Automatic Traction Control



Your truck/tractor ABS has an automatic traction control (ATC) feature. This feature is controlled by a switch. This feature is monitored by a warning lamp located on the switch. The Traction Control warning lamp will briefly illuminate and then go out when the ignition switch is first turned on. The traction control warning lamp will illuminate whenever the ATC system detects drive wheel spin. The lamp will

remain illuminated as long as wheel spin is detected and the ATC system is applying the drive wheel brakes or reducing engine torque. Engine torque or vehicle speed should be reduced to eliminate wheel spin and prevent excessive application of the ATC system.

Except for checking for proper illumination of the ABS and traction control warning lamps when first starting the vehicle, and for monitoring these lamps while driving, no special operating procedures are required. For detailed system description, see literature for your specific ABS that was provided with your vehicle. This feature helps improve traction when vehicles are on slippery surfaces or surfaces with poor traction (i.e. mud or snow) by reducing drive wheel overspin. Automatic traction control works automatically in two different ways:

- If a drive wheel starts to spin, ATC applies air pressure to brake the wheel. This transfers engine torque to the wheels with better traction.
- If all drive wheels spin, ATC reduces engine torque to provide improved traction.

ATC turns itself on and off, you do not have to select this feature. If drive wheels spin during acceleration, the ATC Warning

Lamp comes on, indicating wheel spin control is active. Do not allow the ATC Warning Lamp to remain on continuously for an extended length of time. Extended, continuous use of the ATC can cause overheating of the drive wheel brakes.

Deep Snow and Mud Switch

A deep snow and mud switch is included with Automatic Traction Control (ATC). The Deep Snow and Mud feature is helpful during acceleration. This function increases available traction on extra soft surfaces like snow, mud or gravel, by slightly increasing the permissible wheel spin. When this function is in use, the ATC Warning Lamp blinks continuously.

Off-Road ABS Function Switch (option)

Your vehicle may be equipped with a separate switch to activate an Off-Road ABS function. This function is NOT to be used for On-Highway driving but is intended to be used to improve stopping performance in Off-Highway conditions (e.g., loose gravel and mud). The Off-Road ABS function is accomplished by allowing a "wedge" of material to build-up in front of momentarily locked wheels.

- Changes the ABS control limits to allow for a more aggressive ABS function while off-road.
- Improves vehicle control and helps reduce stopping distances in off-road conditions or on poor traction surfaces such as loose gravel, sand, and dirt.
- Allows retarders to function independently of the ABS function.
- If your vehicle does not have an engine retarder, the Off-Road ABS switch will function the same.

**WARNING**

While the off road mode can improve vehicle control and shorten stopping distances, some steering ability may be reduced on certain surfaces resulting from the momentarily sliding tires. Always operate your vehicle at safe operating speeds. Failure to do so may cause you to lose control of the vehicle and could result in an accident or personal injury.

**CAUTION**

Never drive your vehicle on improved roads/highways with the Off-Road ABS function turned on. When you drive your vehicle onto an improved road surface or highway, immediately turn off the Off-Road ABS switch. Failure to do so will cause the ABS system to not function properly in an ABS event under 25 mph and could result in an accident or personal injury.

The ABS lamp flashes slowly during off-road mode engagement. This is done to alert you of a modification to the ABS control software. At speeds above 25 mph, the ABS controller operates in the normal on-highway mode. At speeds between 10 and 25 mph, the ABS control software is modified to allow short periods (0.25 seconds) of locked-wheel cycles. At speeds below 10 mph, the ABS control software is turned off to allow locked wheels. When the Off-Road ABS function is enabled, the Retarder Disable output is turned off. That is, the engine retarders are left to function without ABS intervention. For additional information, see the Off-

Road ABS pamphlet in your vehicle's glove box.

Effectiveness and Limitations

ESC is designed and optimized for trucks and for tractors that tow single trailers. If a tractor equipped with ESC is used to power multiple trailer combinations (known as "doubles" or "triples") the effectiveness of the ESC system may be greatly reduced.

**WARNING**

Exercise extreme care when towing doubles or triples with a vehicle equipped with Electronic Stability Program. Excessive speed and aggressive maneuvers, such as sharp turns, sudden steering inputs or abrupt lane changes should be avoided because these maneuvers could cause loss of vehicle control possibly resulting in an accident involving death or personal injury.

Additionally, the ESC stability system's effectiveness may be greatly reduced if:

- The load shifts due to improper retention, accident damage or the inherently mobile nature of some loads (for example, hanging meat,

live animals or partially laden tankers).

- The vehicle has an unusually high or off-set center of gravity (CG).
- One side of the vehicle drops off the pavement at an angle that is too large to be counteracted by a reduction in speed.
- The vehicle is used to haul double or triple trailer combinations.
- If very rapidly winding steering inputs are inputted at high speeds.
- There are mechanical problems with suspension leveling of the tractor or trailer resulting in uneven loads.
- The vehicle is maneuvering on a high banked road creating either additional side forces due to the weight (mass) of the vehicle or a deviation between expected and actual yaw rates.
- Gusty winds are strong enough to cause significant side forces on the vehicle and any towed vehicles.

To maximize the effectiveness of ESC:

- Loads must be properly secured and evenly distributed at all times.
- Drivers need to exercise extreme caution at all times, and avoid

sharp turns, sudden steering inputs or abrupt lane changes at high speeds, particularly if:

- The vehicle hauls loads that could shift,
- The vehicle or load has a high or off-set center of gravity (CG) when loaded, or
- The vehicle tows doubles or triples.

The ESC system was specifically calibrated and validated only for your vehicle's original factory-built configuration. If your vehicle's chassis components are altered (for example; a wheelbase extension or reduction, tag axle addition or removal, tractor to truck conversion or steering system component change) the ESC system must be disabled immediately by a qualified mechanic.



WARNING

Failure to disable ESC "Electronic Stability Control" when modifying a vehicle could result in a loss of vehicle control possibly resulting in an accident involving death or personal injury.



WARNING

For vehicles equipped with ESC "Electronic Stability Control" do not replace the vehicle's steering wheel with an aftermarket or different part number than originally supplied. Using a different steering wheel could cause ESC to malfunction causing a loss of vehicle control possibly resulting in an accident involving death or personal injury.

Whenever maintenance or repair work is performed to the steering mechanism, linkage, gear, adjustment of the wheel track, or if the steering angle sensor is replaced or the steering wheel is changed or re-centered, the Steering Angle Sensor must be re-calibrated.

**WARNING**

If the Steering Angle Sensor is not recalibrated, the Yaw Control system will not function properly. A uncalibrated sensor could result in a loss of control of your vehicle which can lead to an accident involving death or personal injury.

Retarders

Ideally, you should always slow your vehicle with your retarder (where permitted by law) and use your service brakes only for stopping completely. Operating this way will greatly prolong the life of your brakes.

Various retarders are available, which function against the engine, driveline, or transmission. These are devices that use your engine's power to slow down your vehicle. They save wear and tear on your service brakes and can be a safety feature, too, because they can keep your brakes from overheating.

**WARNING**

Do not use any of the vehicle's retarders in any situation that requires an immediate stop and/or in situations of poor traction (such as wet, icy or snow covered roads). Trying to use the retarder instead of the service brakes may cause a loss of vehicle control, which may result in an accident involving death or personal injury.

**WARNING**

The service brakes must be used in an emergency. The retarder alone might not stop you fast enough to prevent an accident. Failure to comply may result in death, personal injury, equipment or property damage.

The retarder is NOT intended as the primary brake for the vehicle, nor is it an emergency brake. The retarder only helps the service brakes by using pressure to slow the drivetrain. Use the service brakes for quick stops. Do not use the retarder when operating on road surfaces with poor traction (such as wet, icy, or snow covered

roads or gravel). Retarders can cause the wheels to skid on a slippery surface. We recommend that you do not use your engine retarder to slow down when you are bobtailing or pulling an empty trailer.



This vehicle may have a transmission retarder. Take your foot off the throttle and operate the retarder switch. When you do not need full retarder effect, you can apply it intermittently (off and on) to cause gradual or partial slowing. Continuous application of your retarder will cause your hydraulic fluid to get hotter. Intermittent application will help prevent overheating.

**WARNING**

Using an engine retarder can cause a wheel lockup. The trailer is not loading the tires enough to give the traction you may need. When you are bobtail or unloaded, you can have a serious accident if your wheels lock suddenly during braking. You could be killed or injured. Don't use your retarder when you are driving bobtail or with an unloaded trailer.

**WARNING**

Do not rely on your automatic transmission hydraulic retarder to stop your vehicle. If your engine shuts down, the vehicle's retarder will cease to operate which may lead to an accident involving death or personal injury. Always be ready to suddenly apply the service brakes.

Related concepts**Axle and Suspension****Differential Lock**

The vehicle may be equipped with switches to lock the either of the rear axle differentials. Depending on how the vehicle is specified, a combination of individual switches may be available that can lock the interaxle driveline and/or any combination of the forward rear or rear-rear driving axles. The interaxle differential switch allows each axle to turn independently. In certain situations, engaging the interaxle differential lock relieves stress on the rear axles and reduces tire wear. Engaging this switch will also provide better traction in slippery or loose gravel conditions. In the LOCK position, continuous operation on paved, dry surfaces, put stress on the axles, and can possibly damage the internal gears. The switch has a guard to prevent accidental operation of the switch.

Locking the differentials is typically used during ice or snow conditions and without tire chains, unpaved roads that have loose sand, mud or uneven surfaces. Look ahead and predict when the differential needs to be locked. Stop the vehicle and lock the differentials before approaching. While using the differential in the locked position, do not exceed 25 mph (40 km/h). When disengaging the differential lock, reduce the throttle to prevent drivetrain damage.

**WARNING**

Do not put the differential lock in the LOCK position while the wheels are spinning freely (slipping), you could lose control of the vehicle or cause axle damage. Switch to LOCK only when the wheels are not spinning. Failure to comply may result in death, personal injury, equipment or property damage.

Dual Range (Two-Speed) Rear Axle

Your vehicle may be equipped with a two-speed or dual range axle (option). You can select two rear axle ratios for operating

under heavy loads or rough terrain as well as for over the road hauling.



The Low Range provides maximum torque for hauling heavy loads or traveling over rough terrain. The High Range is a faster ratio for highway speeds and general over the road conditions. A switch on the accessory switch panel controls the Dual Range Rear Axle. You will notice that the switch has a guard to protect you from activating it accidentally. Always park your vehicle with the range selector in LOW. Important tips on operating a Dual Range Axle with Interaxle Differential:

- Shift the axle with the inter-axle differential in the unlocked position only.
- When you are driving with poor traction, lock the differential. When you have the differential locked, drive with the axle in LOW range only.
- When you are driving on a surface with good traction, keep the interaxle differential unlocked. You

can drive with the axle in the LOW or HIGH range.

- Always UNLOCK the inter-axle differential before shifting the axle speed range.



WARNING

Never shift the axle when moving downhill. Engine driveline disengagement may occur, eliminating engine retardation and allowing the wheels to spin faster than the current speed of the engine. This may require severe braking to slow the vehicle down and can result in an accident. Failure to comply may result in death, personal injury, equipment or property damage.



CAUTION

If you shift the axle range with the inter-axle differential in LOCK, you could seriously damage the axles. Never shift the axle range with the differential locked.

Proper shifting of the axle depends on the synchronization of engine/driveline and

wheel speed. When you shift the axle, the connection between the engine and wheels is momentarily disengaged while the gearing is synchronized. Normally when the axle is shifted the speed of the engine, axle, and wheels adjust, allowing for proper gear engagement.

When going downhill the wheels will not slow down, but will tend to speed up, which makes gear synchronization almost impossible. As a result, the axle is neither in HIGH nor LOW range and all engine/driveline retardation is lost. Without engine retardation it is more difficult to slow the vehicle down and greater stress is put on the brake system.



CAUTION

To avoid damaging your vehicle shift the axle at slower travel speeds until you are used to driving with a dual range axle.

How to Operate Two Speed Axle - Low to High

These steps should be used if operating a 2 speed axle in LOW range on rough

terrain and preparing to drive on an improved surface.

When you go from rough terrain to highway driving, shift the axle to the HIGH range following this procedure:

1. Be sure the differential is UNLOCKED.
2. Maintain your vehicle speed (accelerator depressed) and move the Range Selector lever to HIGH.
3. Keep driving with the accelerator depressed until you want the axle to shift.
4. To make the axle shift, release the accelerator until the axle shifts. You are now in the HIGH axle range for highway speeds. Shift the transmission normally to reach your desired cruising speed.

How to Operate Two Speed Axle - High to Low

These steps should be used if operating a 2 speed axle in HIGH range on improved roads and preparing to drive on rough terrain.

When you go from highway driving to rough terrain, shift the axle to the LOW range following this procedure:

1. Maintain your vehicle speed (accelerator depressed) and move the Range Selector lever to LOW.
2. Keep driving with the accelerator depressed until you want the axle to downshift.
3. To make the axle downshift, release and depress the accelerator quickly to increase the engine rpm. The axle will shift to LOW range.
4. You are now in the LOW axle range for rough terrain and heavy loads. Shift the transmission normally to maintain the desired speed.

What is an Auxiliary Axle

Adjustable auxiliary axles (commonly known as Pusher or Tag axles) can add to the productivity of the vehicle by increasing the load capabilities of the vehicle when they are in the deployed (down) position.



There are different configurations of axles with different functionality (liftable versus

steerable). Without the extra axle, the excessive weight can reduce the service life of vehicle components such as, but not limited to, the frame rail, axles, suspension and brakes.

Operation of the auxiliary axles includes the proper maintenance of the system and calibration of its controls. Operating the auxiliary axles will also require a firm understanding of the Gross Axle Weight Rating (GAWR) and the load that is being carried.

The vehicle will have switches on the dash to control the position of the auxiliary axles. In certain situations, however, the system will override the controls to protect the axle system. Replace with new text: For Self Steering Lift Axles, the axle will raise when the park brakes are applied or if the vehicle is placed in reverse. For Non-Steer Lift Axles, the axle will only automatically raise if the park brakes are applied and there are no park brakes on the lift axle. Non-Steer Lift Axles do not automatically raise when the vehicle is placed in reverse.

Operating the auxiliary liftable axles must be performed in a manner that does not exceed the axle creep rating. Axle creep ratings are weight and speed limits that are allowed while the vehicle is fully loaded (in excess of the vehicle's standard GAWR)

and the axle is in its up position. Axle creep ratings are assigned by the axle manufacturer and are based on axle model and intended service of the vehicle.

Contact an authorized dealership if you are unable to identify the axle creep rating of this vehicle.

- Lifiable/steerable (axle lift calibration required)
- Lifiable/non-steerable (axle lift calibration required)
- Non-lifiable (some suspensions require dump valve calibration)



WARNING

Do not operate or park the vehicle with auxiliary axles in the down/ loaded position when vehicle is unladen, or is being unloaded. Raise or dump air into driver controlled auxiliary axle(s) prior to unloading vehicle. Failure to do so can result in loss of vehicle control or rollaway that may result in death, personal injury, equipment or property damage.

Related concepts

Auxiliary Axle Pressure Regulator

Information on using the auxiliary axle pressure regulator.

Vehicles with liftable auxiliary axles will have knobs available to adjust the pressure in the auxiliary axle suspension. These knobs are in addition to the tag and pusher axle switches that control the axle position.

Adding more pressure to the auxiliary axle will increase the pressure the auxiliary axle pushes down. Increasing pressure will decrease load on the drive axles and will decrease traction. Decreasing pressure will transfer more weight to the drive axles and will result in more traction from the drive axles.

Deflate the auxiliary axle suspension before coupling or uncoupling a trailer. After the trailer is coupled or de-coupled, then increase pressure to balance traction and axle load requirements. Inflate air springs of the auxiliary axles to the desired pressure after coupling to a loaded trailer while still maintaining proper traction of the drive axles.

Adjust the pressure regulator control knob to a lower pressure until desired traction is obtained. By reducing air pressure at

pusher or tag axle, load will be transferred to drive axles. Do not overload drive axles. Always deflate air springs of the auxiliary axles before attempting to unload vehicle. This allows maximum traction of the drive axles to control the vehicle.

Depending on the suspension, various calibrations may be required. Contact your authorized dealer or axle/suspension manufacturer for specific calibration procedures.

Some suspensions require dump valve calibration. For example, some dead axles do not lift, but the air can be dumped out of them to unload them when empty. Air pressure is controlled via an adjustable regulator. These axles need to be calibrated for load.

Contact your authorized dealer or axle/suspension manufacturer for dump valve calibration procedures.

What is Axle Creep Rating

Vehicles outfitted with auxiliary axles, and full truck configuration, will have an axle creep rating which defines how much load is allowed when the vehicle has a full load and maneuvering the vehicle, at very slow speeds, with auxiliary axles in the up position. In these situations, the load

exceeds the gross axle weight rating of the axles.

Operator's using vehicles equipped with liftable auxiliary axles must consider creep ratings when any liftable axle is unloaded or in the raised position. Liftable auxiliary axles should only be raised (or unloaded) to improve maneuverability in an off-road use or when vehicle is unloaded.

 **WARNING**

Never operate the vehicle with more pressure in the lift axles than is necessary to carry the load, as determined by the calibration procedure described. Failure to do so can result in loss of traction and stability at the steer and/or drive axles and can result in increased braking distance, which could cause loss of vehicle control resulting in an accident. Failure to comply may result in death, personal injury, equipment or property damage.

 **NOTE**

Axle Creep ratings **MUST NOT** be exceeded.

 **CAUTION**

Always lower the axles as soon as possible after receiving a load. Never exceed 5 miles per hour when driving with a load with the auxiliary axle(s) raised/unloaded. Failure to lower the axle(s) can overload the frame and remaining axles, and could cause equipment damage.

 **CAUTION**

DO NOT modify the air system and/or control functionality on a factory installed auxiliary axle(s). Modifying the factory operation of the pusher and/or tag axle(s) will void your warranty, and can cause equipment damage.

 **CAUTION**

A change in tire size on either the auxiliary axles or the drive/steer axles can change the calibration of the auxiliary axles. If tires are installed with a different loaded radius, the calibration procedure must be repeated. Failure to do so can cause equipment damage.

Contact your dealer or axle manufacturer to determine what the creep rating is for your particular axle(s) and configuration. Creep ratings are generally limited to the following:

- Tandem rear axles only
- Straight trucks only
- Maximum spring mount centers per axle manufacturers specifications
- Maximum tire static loaded radius (SLR) per axle manufacturers specifications

Related concepts

Pusher or Tag Suspension Calibration

Calibrating the suspension is important to ensure that the correct axle loads meet

weight limits and obtain the proper load distribution.

Perform this procedure at or near a weight scale. Procedure can be performed while parked on the weight scale if scale is available. To obtain the desired axle load distribution, you must correlate the suspension air gauge pressure to the actual axle load by scaling the axle weight(s) and adjusting the pressure to obtain the desired load. Once the desired load or load range is achieved, document the pressure-to-load ratio or setting for future use.

 NOTE
<p>This procedure must be performed prior to placing the vehicle into service.</p>

Add: Perform this procedure at or near a weight scale. Procedure can be performed while parked on the weight scale if scale is available.

Setting the Pressure-to-Load Ratio To obtain the desired axle load distribution, you must correlate the suspension air gauge pressure to the actual axle load by scaling the axle weight(s) and adjusting the pressure to obtain the desired load. Once the

desired load or load range is achieved, document the pressure-to-load ratio or setting for future use.

These instructions are general in nature. For more specific instructions, review the pusher or tag suspension manufacturers maintenance manual or contact the nearest authorized dealer.

1. Park loaded vehicle on level surface with wheels blocked.
2. Release vehicles spring brakes. (Do not release for Liftable/Non-Steerable pusher or tag axles).
3. Lower the pusher/tag axles with the axle lift control flip valve. (For some non-liftable axles, inflate air suspension).
4. Adjust the amount of load on each axle by turning the pressure regulator clockwise to increase the load or counterclockwise to decrease the load. (The suspension manufacturer may publish pre-established Pressure-to-Load Ratio Pressure Settings to assist you in achieving an estimated ground load).
5. After setting the pressure to obtain the desired axle load, verify proper

ground loading with the weight scale.

 NOTE
<p>Exceeding local, state or federal weight limits may result in citations. Contact your local commercial weight enforcement office for limits in your area.</p>

 NOTE
<p>Steerable-pusher and/or tag axle(s) will raise when the transmission is shifted into reverse or when the parking brakes are applied.</p>

Air Suspension Ride Height

Information on air suspension and adjusting the ride height.

Vehicles equipped with rear or front air suspensions have their ride height and axle (pinion) angle(s) preset at the factory. These are precision settings and should not be altered. Incorrectly adjusted ride height may result in improper interaxle U-

joint working angles. This can result in premature driveline wear and driveline vibration.

If it becomes necessary to reset the ride height, you may temporarily set it by following the next procedure. Proper ride height measurement and values are shown in the illustration and table below.



CAUTION

Completing this procedure will enable you to safely reach the nearest authorized dealer or repair facility to have ride height and pinion angle reset using the proper equipment and technique. Do this as soon as possible to avoid potential driveline damage.



NOTE

Suitable wheel chocks are at a minimum an 18-inch (46 cm) long 4x4.

1. Park the vehicle, engage the parking brakes and clock the wheels.
2. Locate the air suspension ride height valve

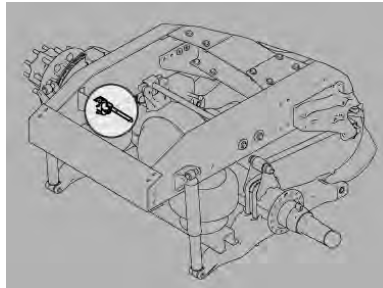

3. Ensure that the tractor is fully laden during this procedure. Do not use these procedures on a vehicle that is not laden (bobtail).
4. Ensure the air supply and delivery plumbing of the height control valve is consistent with the following illustrations.
5. Loosen the fasteners mounting a height control valve to its bracket.

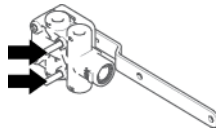

6. Rotate the valve either clockwise or counterclockwise until air pressure in the air springs provides the ride height specified for that

suspension. Measure the ride height from the bottom of the frame rail to the approximate centerline of the rearmost drive axle hub:

- For tandem axles, make the vertical measurement at the centerline of the suspension
 - For a single axle, make the measurement in front of the axle, in the area forward of the tires but not past the suspension bracket.
7. When at the correct ride height, ensure that the height control valve lever is in the neutral position, then install either the built-in alignment pin or a 1/8-inch (3 mm) dowel.

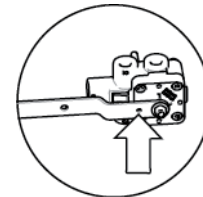

8. Torque the mounting fasteners to 55-75 lb-in (6.2-8.5 Nm.).
9. Remove the alignment pin or dowel.

- Repeat Steps 2 through 6 above for the RH valve on vehicles with a dual-valve system.

Suspension Air Pressure Gauge & Switch

General information about the air suspension pressure gauge and switch.

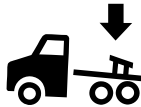

Your vehicle may have an air suspension and a deflation switch which allows the air in the suspension to be exhausted from a switch on the dash. The normal purpose of this feature is to allow you to lower the vehicle for loading. A guard on the switch prevents you from accidentally deflating the suspension.

The Suspension Air Pressure gauge (option) indicates the amount of air pressure in the air suspension springs in pounds per square inch (psi). Air pressure in the spring is related to the rear axle load. The greater the rear axle load, the greater the air pressure in the air bags. Therefore, the air pressure displayed will vary, depending upon the rear axle load.

Air Ride Height Data

These are factory settings for ride height of the rear air suspension.

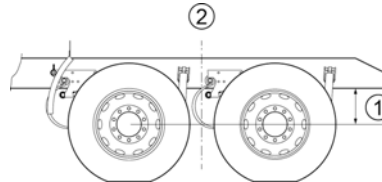

- Ride Height
- Centerline of suspension

Single Axle	Laden Ride Height - inches (mm)
Air Trac	11.00 (279)
Low Air Leaf	6.50 (165)

Single Axle	UnLaden Ride Height - inches (mm)
Air Trac	11.39 (289)
Low Air Leaf Built Before April 2004	8.75 (222)

Single Axle	UnLaden Ride Height - inches (mm)
Low Air Leaf Built After April 2004	6.75 (171)

Tandem Axle	Laden Ride Height - inches (mm)
Air Leaf	11.70 (297)
Air Trac	11.00 (279)
Low Air Leaf	8.50 (216)
Low Low Air Leaf	6.50 (165)
FLEX Air	8.50 (216)

Tandem Axle	Unladen Ride Height - inches (mm)
Air Leaf	12.0 (305)
Air Trac	11.38 (289)
Low Air Leaf	8.75 (222)
Low Low Air Leaf	6.75 (171)

Tandem Axle	Unladen Ride Height - inches (mm)
FLEX Air	8.75 (222)

What to do if an Air Spring Ruptures

If an air spring is ruptured, drive the vehicle to a safe stop off the highway to investigate the problem.



WARNING

Do not continue to drive with ruptured air springs. The air loss can cause the spring brakes to apply allowing your brakes to drag and burn up the linings, which could lead to an accident causing death or personal injury. Do not continue to operate the vehicle in this condition.



WARNING

Do not drive the vehicle if the air pressure is less than 100 psi (690 kPa). Driving the vehicle with less than 100 psi (690 kPa) could make the brakes unsafe to use which could cause an accident involving death or personal injury.



CAUTION

Operating a vehicle with air suspension bags either overinflated or underinflated may cause damage to drive-line components. If a vehicle must be operated under such conditions, do not exceed 5 mph (8 km/h). Failure to comply may result in equipment damage.

You can get to a repair facility by removing the height control link connected to the axle and to the suspension air valve control arm. This will cause the air valve control arm to center in the closed position. Removing the link will allow the air system

of the truck to operate normally so that the vehicle can be driven to a service center.

Aftertreatment System

General information on the emissions aftertreatment system in your vehicle.

This vehicle has an exhaust Aftertreatment System (ATS), to control vehicle exhaust emissions. The exhaust Aftertreatment system consist of a Diesel Particulate Filter (DPF), Selective Catalyst Reduction (SCR), Regeneration Switch and warning lights. The DPF will trap soot from the engine exhaust gases. The SCR uses Diesel Exhaust Fluid to reduce the levels of

NOx in the engine exhaust. The ATS will periodically clean (regenerate) the DPF.

Aftertreatment System Detail

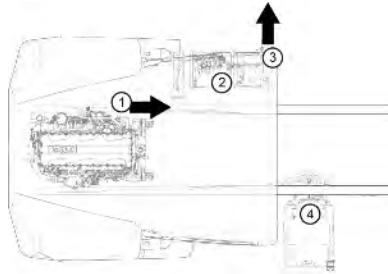

1. Hydrocarbon Doser from Turbo
2. Aftertreatment Unit (DPF, DEF Doser and SCR)
3. Filtered/Treated Exhaust
4. Diesel Exhaust Fluid (DEF) Tank

Please refer to the Exhaust Aftertreatment System Supplement provided with the vehicle for more detailed description of functionality and warnings.

Driving Tips and Techniques

Guidelines for properly driving your vehicle.

This section covers additional driving tips and techniques on how to drive your vehicle more efficiently.

Coasting



WARNING

Do not coast with the transmission in neutral or with the clutch pedal depressed—it is a dangerous practice. Coasting in neutral may result in damage to your drivetrain when you try to re-engage the transmission. You could lose control of the vehicle which can lead to an accident involving death or personal injury.

Do not coast with the transmission in neutral or with the clutch pedal depressed. Besides being illegal and dangerous, coasting is also expensive. It causes premature failure or damage to the clutch and transmission and overloads the brake

system. Coasting with the transmission in neutral also prevents proper transmission component lubrication. During coasting the transmission is driven by the rear wheels, and the countershaft gear (which lubricates the transmission components by oil splash) will only be turning at idle speed.

Descending a Grade



WARNING

Do not hold the brake pedal down too long or too often while going down a steep or long grade. This could cause the brakes to overheat and reduce their effectiveness. As a result, the vehicle will not slow down at the usual rate. To reduce the risk of an accident which could cause death or personal injury, before going down a steep or long grade, reduce speed and shift the transmission into a lower gear to help control your vehicle speed. Failure to follow procedures for proper downhill operation could result in loss of vehicle control.

Engine Overspeed



CAUTION

To avoid engine damage, do not let the engine rpm go beyond the maximum governed rpm—valve damage could result if overspeed conditions occur.



NOTE

Often these recommendations are secondary to maintaining an adequate and safe speed relative to the surrounding traffic and road conditions.

Operate the engine within the optimum engine rpm range and do not allow the rpm's to exceed the maximum governed speed. See your Engine Operation and Maintenance manual for information regarding engine rpm. When the engine is used as a brake to control vehicle speed (e.g., while driving down a grade), do not allow the engine rpm to exceed maximum governed speed. Under normal load and road conditions operate the engine in the lower end of the range.

The tachometer is an instrument that aids in obtaining the best performance of the engine and manual transmission, serving as a guide for shifting gears. Refer to the Engine Operation and Maintenance manual for optimum engine rpm.

- If the engine rpm moves beyond the maximum governed speed, indicating an overspeed condition, apply the service brake or shift to a higher gear to bring engine rpm within the optimum speed range.
- When driving downhill: shift to a lower gear, use the engine brake (if so equipped), and use the service brake, keeping the engine speed below 2,100 rpm.

When the engine speed reaches its maximum governed speed, the injection pump governor cuts off fuel to the engine. However, the governor has no control over the engine rpm when it is being driven by the vehicle's transmission, for example, on steep downgrades. Apply service brakes or shift to a higher gear. Fuel economy and engine performance are also directly related to driving habits:

- The best results in trip time and fuel economy are obtained while driving the vehicle at a steady speed.

- Shift into higher or lower gears (or apply the service brake) to keep engine rpm near the lower end of the optimum operating range.
- Avoid rapid acceleration and braking.



WARNING

Do not look at the Instrument Cluster Display for prolonged periods while the vehicle is moving. Only glance at the monitor briefly while driving. Failure to do so can result in the driver not being attentive to the vehicle's road position or situation, which could lead to an accident and possible death, personal injury or equipment damage.

The Instrument cluster display provides information to help the driver optimize vehicle efficiency. [Optimal RPM Indicator](#) on page 63. A driver will find the section describing Trip Information and the rpm detail useful.

Fuel Consumption

The vehicle's fuel consumption is connected to five important factors: maintenance, driving habits, general

condition of the road, traffic conditions, and vehicle load.

Proper maintenance will keep the vehicle running like new even after long periods of use. The driver must perform the daily and weekly checks of the vehicle.

Maintenance factors affecting fuel consumption:

- air and/or fuel filters partially clogged
- engine valves out of adjustment
- injection pump improperly synchronized
- injection nozzles defective or uncalibrated
- improperly inflated tires
- wheel bearings improperly adjusted
- clutch improperly adjusted or worn (slipping)
- fuel leaks

Wrong driving habits must be corrected and the recommendations on economic driving should be followed. Driving factors affecting fuel consumption:

- excessive speed and unnecessary fast acceleration
- long periods of idling
- driving with foot resting on the (manual transmission) clutch pedal

General Condition Other factors affecting fuel consumption are related to loads and type of roads on which the vehicle operates. It is not always possible to choose the most adequate road, but it must be kept in mind that the ideal road is the one that allows a steady speed in high gear, without requiring frequent braking and acceleration. The following general conditions can affect fuel consumption:

- overload
- unbalanced load
- very high load
- inadequate roads
- traffic conditions

Optimal Engine Speed Indicator

The tachometer displays a green bar just below the most efficient engine speed for the vehicle.



The placement and size of this bar is dependent on the engine as installed at the

factory. The driver's general goal should be to select a gear that keeps the tachometer needle positioned over the green light as much as possible during steady state driving. In addition to proper maintenance and good driving habits, this visual cue can help minimize the fuel consumption.

Driver Performance Assistant (Optional)

Driver Performance Assistant (DPA) is an optional feature that encourages driving habits that result in good fuel economy.



The model of good fuel economy maximizes momentum and minimizes unnecessary throttle application. A current average driver performance score is presented to the driver each time the vehicle is turned on and when viewing the DPA function selectable with the menu control switch. This performance score is the average of the Coasting and Gentle Braking scores. These scores are also displayed on the same screen.

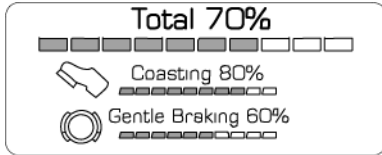

Heavy, aggressive use of the brake pedal, instead of coasting or using the engine brake, will decrease these scores which are averaged over the time and distance logged by the DPA system. The DPA is programmed to provide operational feedback and suggestions that will improve overall fuel consumption (and subsequently, a better score). The highlighted check marks will indicate how well the operator is contributing to increased fuel efficiency and decreased brake wear.



For example, if the vehicle brakes are applied frequently with little coasting or engine braking, a pop-up message appear with the message **Gentler Braking Saves Fuel**.

Adjust the Driver Performance Assistant Feature

The operator is allowed to reset the trip meter that the system uses to calculate the performance scoring, change the coaching tips to 'on' or 'off' and view additional fuel economy improvement tips.

While parked, the operator may modify system messages and reset the calculation interval. If a menu selection is grayed out, then the operator does not have the permission to alter the setting.

1. With the vehicle's Parking Brakes set and the ignition ON or in accessory mode, use the Menu Control switch to navigate to the "Driver Performance" feature.
2. Push the Menu Control switch to enter the "Driver Performance" submenu.
3. Scroll the menu control switch to the submenu item you desire to use.

What to Consider when using a Sleeper Bunk

If your vehicle has an upper and lower bunk, the upper bunk can be folded up out of the way to provide you with more dressing area in the sleeper cab. The lower bunk has storage underneath it to stow your luggage and other belongings. The upper bunk weight limit is 320 lb (145 kg).



WARNING

Always keep the lower bunk in its down (latched) position while the vehicle is moving. If left open, stored items could become loose during an accident and strike you. Before you move the vehicle, check to be sure the lower bunk is latched securely. Failure to comply may result in death or personal injury.

**WARNING**

Be sure the latch that holds the upper bunk in the folded position is working properly so the bunk will not fall down. If the bunk falls, you could be injured.

**WARNING**

Any loose items on the upper or lower bunk should be moved to a secured place before driving the vehicle. Failure to comply may result in death, personal injury, equipment or property damage.

**WARNING**

Be sure the restraint system is used when anyone is occupying the sleeper while the vehicle is moving. In an accident, an unrestrained person lying in a sleeper bunk could be seriously injured. He or she could be thrown from the bunk. Failure to comply may result in death, personal injury, equipment or property damage.

**WARNING**

Be sure no one ever rides in the upper bunk. That person could be thrown out in an accident and could be very seriously injured. The upper bunk is not equipped with a restraint system. Do not use the upper bunk while you are moving. Failure to comply may result in death, personal injury, equipment or property damage.

The sleeper restraint is stored in a compartment on the rear sleeper cab wall. [Sleeper Bunks and Restraints](#) on page 32, for more information on cab/seat restraint systems.

**WARNING**

Failure to properly use the sleeper restraint when an individual is located in the sleeper bunk and the vehicle is moving can result in death or personal injury.

To Lower Upper Bunk

Pull on the lanyard in the upper left corner of the bunk to release the bunk.

To Raise Upper Bunk

This will free it from the anchored position and allow you to lower the bunk.

Fold the upper bunk up and push it against the retaining latch until you hear a click. Pull on the bunk to be sure it is latched securely.

Upper Bunk Ladder Considerations

If your vehicle is equipped with the upper bunk ladder, ensure that you follow the safety tips as detailed in [How to Access the Upper Bunk](#) on page 15.

Stopping the Vehicle

A hot engine stores a great amount of heat. It doesn't cool down immediately after you shut it off. Always cool your engine down before shutting it off. You will greatly increase its service life. Idle the engine at 1000 rpm for five minutes. Then low idle for thirty seconds before shutdown. This will allow circulating coolant and lubricating oil to carry away heat from the cylinder head, valves, pistons, cylinder liners, turbocharger, and bearings. This way you can prevent

serious engine damage that may result from uneven cooling.

Turbocharger

This cooling-down practice is especially important on a turbocharged engine. The turbocharger contains bearings and seals that are subjected to hot exhaust gases. While the engine is operating, heat is carried away by circulating oil. If you stop the engine suddenly, the temperature of the turbocharger could rise as much as 100°F (55°C) above the temperature reached during operation. A sudden rise in temperature like this could cause the bearings to seize or the oil seals to loosen.

Refueling

Air space in your fuel tanks allows water to condense there. To prevent this condensation while you are stopped, fill your tanks to 95 percent of capacity. When refueling, add approximately the same amount to each fuel tank on vehicles with more than one tank.



WARNING

Do not carry additional fuel containers in your vehicle. Fuel containers, either

full or empty, may leak, explode, and cause or feed a fire. Do not carry extra fuel containers. Even empty ones are dangerous. Failure to comply may result in death or personal injury.



WARNING

Diesel fuel in the presence of an ignition source could cause an explosion. A mixture of gasoline or alcohol with diesel fuel increases this risk of explosion. Do not remove a fuel tank cap near an open flame. Use only the fuel and/or additives recommended for your engine. Failure to comply may result in death, personal injury, equipment or property damage.



CAUTION

Use only Ultra Low Sulfur Diesel (ULSD) Fuel, as recommended by engine manufacturers. If you need further information on fuel specifications, consult the Engine Operation and Maintenance Manual.

If your vehicle is equipped with fuel shut-off valves for the take-off and return lines, they are located on the fuel lines entering the top of the fuel tank. Fuel shut-off valves for the fuel crossover line are on the bottom of the fuel tank, at the crossover line connection.

Final Stopping Procedures

These suggestions will help ensure that your vehicle is ready to go after a long stop (such as over night).

Your vehicle will be easier to get going when you are ready, and it will be safer for anyone who might be around it. Please remember, too, that in some states it is illegal to leave the engine running and the vehicle unattended.

**WARNING**

Using the trailer hand brake or air brakes to hold a parked vehicle is dangerous. Because they work with air pressure, these brakes could come loose. Your vehicle could roll, causing an accident involving death or personal injury. Always set the parking brakes. Never rely on the trailer hand brake or truck air brakes to hold a parked vehicle.

1. Set the parking brake before leaving the driver's seat. To hold your vehicle while it is parked, don't rely on:
 - Air Brakes
 - Hand Control Valve for Trailer Brakes
 - Engine Compression
2. If you are parked on a steep grade, block the wheels.

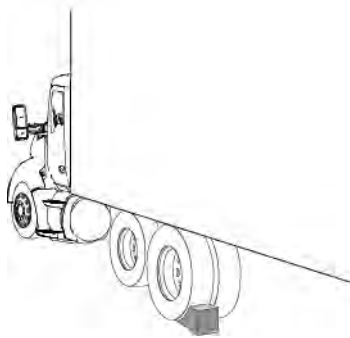

3. Drain water from the air reservoirs. While the engine and air supply system are still warm, drain moisture from the air reservoirs. Open the reservoir drains just enough to drain the moisture. Don't deplete the entire air supply. Be sure to close the drains before leaving the vehicle.

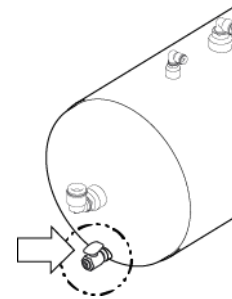

4. Secure the vehicle. Close all the windows and lock all the doors.

Chapter 5 | MAINTENANCE

In this Chapter:

Maintenance Schedule.....	174
New Vehicle Maintenance Schedule.....	204
Lubricants.....	205
Checking Oil Level.....	206
Inspect Power Steering Fluid.....	207
What is the Air System?.....	207
Air Dryer Maintenance.....	209
Air Tanks.....	211
How to Check for Air System Leaks.....	212
What is an Air Compressor?.....	213
Brake System.....	213
Cab Maintenance.....	216
Safety Restraint System - Inspection.....	221
Cooling System Maintenance.....	223

Windshield Wiper/Washer.....	228
Electrical System.....	228
Engine Maintenance.....	237
Fuel System.....	246
Frame.....	247
Front Axle and Suspension.....	248
Heater and Air Conditioner Maintenance.....	250
Noise and Emission Control.....	253
Rear Axle and Suspension.....	255
Steering System.....	258
Driveline.....	260
Tires.....	261
Wheels.....	264
Transmission Maintenance.....	267
Hydraulic Clutch.....	267
Specification Reference Charts.....	268

Maintenance Schedule

Preventive maintenance program begins with the daily checks. Routine vehicle checks can help avoid many large, expensive, and time consuming repairs. The vehicle will operate better, be safer, and last longer. Neglect of recommended maintenance can void your vehicle's warranty. Some maintenance operations demand skills and equipment you may not have. For such situations, please take your vehicle to an authorized Service Center.

 **WARNING**

Before attempting any procedures in the engine compartment, stop the engine and let it cool down. Hot components can burn skin on contact. Failure to comply may result in death, personal injury, equipment or property damage.

 **WARNING**

If the engine must be operating to inspect, be alert and cautious around

the engine at all times. Failure to comply may result in death, personal injury, equipment or property damage.

 **WARNING**

If work has to be done with the engine running, always (1) set the parking brake, (2) block the wheels, and (3) ensure that the shift lever or selector is in Neutral. Failure to comply may result in death, personal injury, equipment or property damage.

 **WARNING**

Exercise extreme caution to prevent neckties, jewelry, long hair or loose clothing from getting caught in the fan blades or anyother moving engine parts. Failure to comply may result in death, personal injury, equipment or property damage.

 **WARNING**

Always support the vehicle with appropriate safety stands if it is necessary to work underneath the vehicle. A jack is not adequate for this purpose. Failure to comply may result in death, personal injury, equipment or property damage.

 **WARNING**

When working underneath the vehicle without appropriate safety stands but with the wheels on the ground (not supported), make sure that (1) the vehicle is on hard level ground, (2) the parking brake is applied, (3) all wheels are blocked (front and rear) and (4) remove the ignition key so that the engine cannot be started. Failure to comply may result in death, personal injury, equipment or property damage.



WARNING

Never start or let the engine run in an enclosed, unventilated area. Exhaust fumes from the engine contain carbon monoxide, a colorless and odorless gas. Carbon monoxide can be fatal if inhaled. Failure to comply may result in death, personal injury, equipment or property damage.



WARNING

Disconnect the battery ground cable whenever you work on the fuel system or the electrical system. When you work around fuel, do not smoke or work near heaters or other fire hazards. Keep an approved fire extinguisher near to you. Failure to comply may result in death, personal injury, equipment or property damage.

The following pages contain a table of maintenance tasks with the related intervals for each task on the right side of

the table. The top of the table displays a guide to a maintenance interval and its schedule. Some tasks are dependent on the vehicle application. These tasks will be shown as separate tasks and will have the words “ON HIGHWAY”, “CITY DELIVERY” or “OFF-HIGHWAY” after the description. These tasks are differentiated because they are dependent on the vehicle’s operating environment. On highway is defined for applications where the vehicle is NOT used off of a paved road during normal operation. City Delivery is defined for applications where frequent start and stopping is required during normal operation and the highway is used infrequently and for short periods of time. Off highway is defined for applications where the vehicle may be driven off the pavement on a regular basis, even if it is an infrequent basis and/or for a brief time period. Please contact an authorized service dealership if there are questions regarding which interval to follow. Consult the supplier for specific recommendations where discrepancies develop between these recommendations in this table and component supplier recommendations.

- Engine lubricating oil change intervals aren’t listed here. Refer to your engine’s operating manual for recommendations. For specific information on maintenance procedures consult your vehicle maintenance manual.
- The initial fill of drive axle lubricant must be changed before the end of the first scheduled maintenance interval. See the axle manufacturer’s operator’s manual for recommended lubrication specifications and service intervals.
- The initial fill of lubricant in manual transmissions must be changed before the end of the first maintenance interval. See the transmission manufacturer’s operator’s manual for recommended lubrication specifications and service intervals.
- If your vehicle is equipped with an automatic transmission, consult the owner’s manual for it that came with your vehicle to obtain lubricant check and change intervals.

Preventative Maintenance Intervals

I	A	B	C	D	E
At first 15,000 mi/ 24,000 km or at first PM	15,000 mi/24,000 km/Monthly	30,000 mi/48,000 km	60,000 mi/96,000 km/ 6 Months	120,000 mi/ 192,000 km/ Annually	240,000 mi/ 384,000 km

Maintenance Schedule

System	Component	Task	I	A	B	C	D	E
Frame	Fifth Wheel	Check the kingpin lock and plate for wear and function: lubricate (NLGI #2 grease).		.				
		Inspect fifth wheel operation; see Frame Fastener Torque Requirements on page 275				.		
	Frame Fasteners	Check for tightness: tighten to the specified torque value as required; see Frame Fastener Torque Requirements on page 275.					.	
	Crossmembers and Mounting Brackets	Inspect for cracks and loose fasteners. Replace or tighten to the specified torque value as required; see Frame Fastener Torque Requirements on page 275.					.	
	Engine Mounting	Inspect engine mounts every 60,000 miles (96,560 km); see Engine Mounting on page 246. Contact an authorized vehicle OEM dealership if engine mounts need servicing.				.		

5

System	Component	Task	I	A	B	C	D	E
Front Axle	Total Vehicle Alignment	Check and adjust as required.	•				•	
	Steering Knuckle Spindles, Thrust Bearings, Kingpins, Drawkeys, Tie Rod Ends, Steering Stops, and Bushings.	Inspect for wear and damage and endplay. Shim or replace as required; see Front Axle and Suspension on page 248.					•	
	Kingpin Bushings, Thrust Bearings, and Tie Rod Ball Ends	Lubricate with approved grease.				•		
	Drawkeys	Tighten nuts	•		•			
Front Axle (Dana)	Total Vehicle Alignment	Check and adjust as required.	•				•	
	Kingpin Bushings, Thrust Bearings, and Tie Rod Ball Ends (ON HIGHWAY)	Lubricate with approved grease.					•	
	Kingpin Bushings, Thrust Bearings, and Tie Rod Ball Ends (OFF-HIGHWAY)	Lubricate with approved grease.				•		
	Steering Knuckle Spindles, Thrust Bearings, Kingpins, Drawkeys, Tie Rod Ends, Steering Stops, and Bushings (ON HIGHWAY)	Inspect for wear and damage and for endplay. Shim or replace as required.					•	
	Steering Knuckle Spindles, Thrust Bearings, Kingpins, Drawkeys, Tie Rod Ends, Steering Stops, and Bushings (OFF-HIGHWAY)	Inspect for wear and damage and for endplay. Shim or replace as required.				•		

System	Component	Task	I	A	B	C	D	E
Front Suspension	Front Spring	Inspect for cracked leaves, worn bushings, and excessive corrosion.				•		
	Spring Pins and Shackles	Inspect for worn parts and excessive joint clearance. Shim or replace as required.				•		
	Shock Absorbers	Inspect for leaking, body damage, and damaged or worn bushings. Replace as required. Check the shock mounting stud torque.				•		
	Spring Pins	Lubricate with approved grease.			•			
		Check for proper function.		•				

5

System	Component	Task	I	A	B	C	D	E
Front Suspension U-bolts	U-bolts (ON HIGHWAY)	Check the general condition and the tightness of the nuts. Tighten the nuts to the specified torque value as required; see Suspension U-Bolts, Grade 8 on page 276.	•			•		
	U-bolts (VOCATIONAL)	Check the general condition and the tightness of the nuts. Tighten the U-bolts after the first day or two of operation. Then tighten the nuts to the specified torque value as required; see Suspension U-Bolts, Grade 8 on page 276.	•			•		
	U-bolts (OFF HIGHWAY)	Check the general condition and the tightness of the nuts. Tighten the U-bolts after the first day or two of operation. Then tighten the nuts to the specified torque value as required; see Suspension U-Bolts, Grade 8 on page 276.		•				

System	Component	Task	I	A	B	C	D	E
Drive Axle (Dana)	Axle Housing	Visually inspect for damage or leaks.				•		
		Check oil level. Check "cold." Torque the drain plug.				•		
		Drain the lubricant while warm. Flush each unit with clean flushing oil. Change the lubricant.	See manufacturer's service requirements.					
	Air Shift Unit	Check the lubricant level.				•		
		Remove the housing cover and drain the lubricant. Wash the parts thoroughly and dry in air.					•	
	Breather	Clean or replace.					•	
	Lube Pump (ON HIGHWAY)	Remove the magnetic strainer and inspect for wear particles. Wash in solvent and dry in air.					•	
	Lube Pump (OFF HIGHWAY)	Remove the magnetic strainer and inspect for wear particles. Wash in solvent and dry in air.				•		
	Lube Filter (ON HIGHWAY)	Change.					•	
Lube Filter (OFF HIGHWAY)	Change.				•			

5

System	Component	Task	I	A	B	C	D	E
Drive Axle (Dana)	Magnetic Drain Plug and Breather (ON HIGHWAY)	Clean or replace.					.	
	Magnetic Drain Plug and Breather (OFF HIGHWAY)	Clean or replace.				.		
Drive Axle (Meritor Line Haul / ON HIGHWAY)	Axle Housing	Check the "cold" fill level at the differential carrier plug for a pinion angle of less than 7 degrees, or at the axle bowl plug for a pinion angle of greater than 7 degrees. Tighten the plug to 35-50 lb-ft (47-68 Nm)			.			
		Visually inspect for damage or leaks.			.			
		Drain and replace the lubricant	See Rear Axle Lubrication on page 257					
	Lubricant Filter	Change the filter					.	
	Breather	Check the operation. If the cap doesn't rotate freely, replace.			.			
	Input Shaft and Pinion Shaft	Check and adjust the endplay.					.	
	Axle Shaft	Tighten the rear axle flange nuts to the specified torque value.					.	
	Interaxle Differential	Check the operation.					.	

System	Component	Task	I	A	B	C	D	E
Drive Axle (Meritor City Delivery / OFF HIGHWAY)	Axle Housing	Check the "cold" fill level at the differential carrier plug for a pinion angle of less than 7 degrees, or at the axle bowl plug for a pinion angle of greater than 7 degrees. Tighten the plug to 35-50 lb-ft (47-68 Nm)		.				
		Visually inspect for damage or leaks.		.				
		Drain and replace the lubricant.	See Rear Axle Lubrication on page 257					
	Lubricant Filter	Change the filter					.	
	Breather	Check the operation. If the cap doesn't rotate freely, replace.		.				
	Input Shaft and Pinion Shaft	Check and adjust the endplay.					.	
	Axle Shaft	Tighten the rear axle flange nuts to the specified torque value.					.	
Interaxle Differential	Check the operation.					.		

System	Component	Task	I	A	B	C	D	E
Drive Axle (SISU)	Axle Housing	Change the oil in the differential carrier and the hubs, and clean the magnetic oil drain plugs.	.				.	
		Check the wheel bearing hubs and adjust if necessary.	.			.		
		Visually inspect for damage or leaks.	.			.		
		Check the oil level in the differential carrier and hubs.				.		
	Breather	Check the breather for proper operation.				.		
	Lube Filter	Clean the suction filter for the optional pressure lubrication system.					.	
S-cam Brakes	Overhaul the brakes: degrease all moving parts, check the bushings and seals for wear.				.			
Rear Suspension	U-bolts	Check the torque. Tighten to specified torque value as	.			.		
	Frame and Crossmembers Bolts	Check the torque. Tighten to specified torque value as					.	
	Mounting Brackets and Fasteners	Check the condition and the fastener torque. Tighten to the specified torque value as required; see <i>Suspension U-Bolts, Grade 8</i> on page 276.	.				.	

System	Component	Task	I	A	B	C	D	E
Drum Brakes (All)	Slack Adjusters	Check the push rod travel and check the control arm for cracks. Adjust at reline; see Auto Slack Adjuster on page 215.		•				
		Lubricate (NLGI #2 grease).		•				
	Brake Camshaft Bearing	Check for excessive camshaft play in the axial and radial directions. Max allowable play is 0.003 in. Lubricate (NLGI #2 grease).				•		
	Brake Treadle Valve	Clean the area around the treadle, boot, and mounting plate. Check the pivot and mounting plate for integrity. Check the plunger boot for cracks. Lubricate roller pin, pivot pin, and plunger (NLGI #2 grease).			•			
	Brake Air System	Check air lines and fittings for leaks; see How to Check for Air System Leaks on page 212. Adjust routing as required to prevent chafing. Check tank mounting and condition.		•				
		Clean or replace the inline filters.				•		
	Brake Lining	Inspect: replace as required.			•			

5

System	Component	Task	I	A	B	C	D	E
Disc Brakes (Bendix®)	Brake Pads	Inspect: replace as required.				•		
	Brake Disc/rotor	Inspect for visible cracks, heat checking, galling, or scoring of surface. Check for runout (max allowable is 0.002 in.).				•		
	Caliper Sliding Function	Ensure caliper slides freely with no obstructions or excessive play.				•		
	Caliper Slide Pins	Inspect protective caps of the guide pins for damage or cracking.				•		
	System Operation	Check operation: inspect as per manufacturer's service literature.				•		

System	Component	Task	I	A	B	C	D	E
Hub, Drum, and Hubcap	Hubs (non-LMS)	Check the bearing endplay and adjust as required; see Wheels on page 264.			•			
	Hubs (non-LMS) with Outrunner Seals	Clean the components and check for excessive wear or damage. Change the oil and seal; see Wheels on page 264.						•
	Hubs (non-LMS) with Standard Seals	Clean the components and check for excessive wear or damage. Change the oil and seal; see Wheels on page 264.					•	
	Hub Seals (all)	Check for leaks: replace as required.			•			
	LMS Hubs (Dana)	Inspect for leaks. Check the bearing endplay and adjust as required; see Wheels on page 264.				•		
	LMS Hubs (Dana) with Synthetic Lubricant	Service the bearings, seals and oil. This interval may be different depending on the results of the regular inspection. See Wheels on page 264.	500,000 miles/ 800,000 km					
	LMS Hubs (Dana) with Mineral Lubricant	Service the bearings, seals and oil. This interval may be different depending on the results of the regular inspection. See Wheels on page 264.	350,000 miles/ 560,000 km					

5

System	Component	Task	I	A	B	C	D	E
Hub, Drum, and Hubcap	Brake Drums	Inspect for visible cracks, heat checking, galling or scoring of the braking surface, and for severe corrosion on the outside surface. Check for out-of-round or oversize condition [0.080 in. (2 mm) more than the original diameter]. Replace as required.			•			
	Hubcaps	Clean the sight window. Check the center plug, mounting flange, and fill plug for leaks and for proper installation. Replace broken or damaged parts. Check the lubricant level and add as required.		•				

System	Component	Task	I	A	B	C	D	E
Main and Auxiliary Transmission (including Eaton Automated or PACCAR Transmission)	Main and Auxiliary Transmission and Transfer Case	Inspect for visible damage, signs of overheating, and leaks.	•	•				
		Check the drain plugs for tightness.			•			
	Mounting Brackets and Fasteners	Check the condition of the fasteners and their torque. Tighten to the specified torque value as required.				•		
	Oil Cooler	Clean the fins (air-to-oil type) and body. Check the hose condition and for leaks: replace as required.				•		
	Main and Auxiliary Transmission	Check the oil level: refill as required.			•			
	Main and Auxiliary Transmission (ON HIGHWAY)	Drain lubricant while warm. Flush each unit with clean flushing oil.	500,000 miles/ 800,000 km					
	Main and Auxiliary Transmission (OFF HIGHWAY)	Drain lubricant while warm. Flush each unit with clean flushing oil.	•			•		
Eaton Automated or PACCAR Transmission (Only)	Air Dryer (Oil-Coalescing Desiccant Cartridge)	Replace Cartridge Air Dryer Maintenance on page 209	Annually regardless of mileage					

System	Component	Task	I	A	B	C	D	E
Auxiliary Transmission	Cotta Transfer Case TR2205 Fabco Transfer Case TC142/TC143/TC170/TC270 Marmon-Harrington Transfer Case MVG2000/MVG2000SD	Inspect: Check oil level, inspect for leaks and any visible damage.		•				
		Initial oil change: Drain oil while warm: flush case with gear oil-compatible fluid, clean magnetic drain plug, and refill. Do not flush the case with any solvent.	•			•		
		Change oil.				•		
Air Intake	Air Intake Piping, Mounting, and Charge Air Cooler	Check the system for broken pipes, leaks, joint integrity, cleanliness, and proper support; see Air Intake System on page 242.				•		
	Air Cleaner	Replace the engine intake air cleaner element.	When required by air restriction indicator or required by the engine manufacturer's operator manual.					
Clutch	Clutch Hydraulic Fluid	Replace fluid and bleed system.	240,000 miles/384,000 km or 2 years, whichever occurs first.					
	Clutch Release Bearing	Lubricate.			•			
		Inspect and adjust when necessary (no adjustment required for SOLO type clutches)			•			

System	Component	Task	I	A	B	C	D	E
Cooling	Hoses	Check the radiator and heater hoses for leaks.	•			•		
	Extended Life Coolant (ELC). See Cooling System Maintenance on page 223.	Check the freeze point.			•			
		Check for contamination using test strips.			•			
		Replace blank water filter if applicable.					•	
		Perform lab analysis. If lab analysis shows coolant is unsuitable for continued use: Flush, drain, and refill. Add ELC Extender.					•	
		Flush, drain, and refill with new coolant.						•
	Fan Clutch	Check for air leaks. See Engine Fan on page 241. Check the fan drive bearings (turn the sheave in both directions to check for worn hub bearings).	•			•		
Solenoid Valve	Check the fan drive for proper engagement and disengagement.	•			•			

System	Component	Task	I	A	B	C	D	E
Tires and Wheels	Tires	Check inflation pressure; see <i>Tires</i> on page 261.	Weekly "cold" using calibrated gauge.					
		Inspect for cuts, irregular wear, missing lugs, sidewall damage, etc.		.				
	Disc Wheels	Inspect the wheel disc for any cracks or surface irregularities. Inspect the rim edge and bead seat area for damage. Replace any damaged wheels - DO NOT ATTEMPT TO REPAIR.		.				
	Demountable Rims	Inspect the mounting ring, rim gutter, side ring, and lock ring for damage: replace as required.		.				
	Wheel Nuts and Studs	Check the tightness of the fasteners and tighten the fasteners to the specified torque as required; see <i>Wheels</i> on page 264.		.				
		Inspect for damaged hex corners, stripped or damaged threads, and excessive corrosion: clean or replace as required.		.				

System	Component	Task	I	A	B	C	D	E
Power Steering	Reservoir	Check the fluid level; see <i>Power Steering Fluid</i> on page 259.		.				
	Reservoir (ON HIGHWAY)	Drain, replace the filter, and refill; see <i>Power Steering Fluid Filter</i> on page 259.	.				.	
	Reservoir (OFF HIGHWAY)	Drain, replace the filter, and refill. See <i>Power Steering Fluid</i> on page 259.	.			.		
	Steering Gear	Check the lash of the sector shaft: adjust as required.				.		
		Grease the trunnion bearing (EP NLGI #2 lithium-based, moly-filled, HD grease).				.		
		Grease the input shaft seal (EP NLGI #2 lithium-based, moly-filled, HD grease).				.		
	Power Assist Cylinder	Lubricate the ball joints. Inspect for leaking rod seals, damaged ball joint boots, and damage to cylinder rod or barrel.		.				
	Hoses and Tubes	Check for leaks and chafing.				.		

System	Component	Task	I	A	B	C	D	E
Steering Components	Steering Linkage	Check all joints for excessive lash: replace as required; see Steering System on page 258.					•	
	Draglink Tube Clamp and Ball Socket	Check the torque: tighten to specified torque value as required.	•			•		
	Pitman Arm Clamp Bolt and Nut	Check the torque: tighten to specified torque value as required.	•			•		
	Steering Intermediate Shaft	Check the torque on the pinch bolt and nut.	•			•		
	Steering Intermediate Shaft U-joints (ON HIGHWAY)	Lubricate [EP NLGI #2 HD grease, +325°F to -10°F (+163°C to -23°C) range].	•			•		
	Steering Intermediate Shaft U-joints (OFF HIGHWAY or CITY DELIVERY)	Lubricate [EP NLGI #2 HD grease, +325°F to -10°F (+163°C to -23°C) range].	•		•			
	Draglink and Tie Rod Arm Ball Sockets (ON HIGHWAY)	Lubricate (EP NLGI #2 lithium-based, moly-filled, HD grease).	•		•			
	Draglink and Tie Rod Arm Ball Sockets (OFF HIGHWAY or CITY DELIVERY)	Lubricate (EP NLGI #2 lithium-based, moly-filled, HD grease).	•	•				

System	Component	Task	I	A	B	C	D	E
Fuel and Tanks	Fuel Tanks	Inspect tanks, brackets, hoses, and fittings for correct location, tightness, abrasion damage, and leaks: repair or replace as required.				.		
	Fuel Tank Breathers	Check for proper function: clean the drain hoses.					.	
	Fuel Tank Straps	Check the strap tightness: tighten to proper torque value as required; aluminum tank - 30 lb-ft (41 Nm) cylindrical steel tank - 8 lb-ft (11 Nm)	.		.			
	Fuel Tank Steps	Check for snug fit of side plates against tank and tank straps. Check for damaged or broken steps, missing bolts, and missing grommet between tank and side plate. Replace missing or damaged parts and adjust for fit as required.		.				

System	Component	Task	I	A	B	C	D	E
Driveshafts	Models SPL-90, 1710 and 1810 Slip Member and U-joints	Lubricate *	•	•				
		Inspect	U-joint inspections should be performed every time a vehicle comes in for scheduled maintenance. **					
	Model SPL-100 Slip Member and U-joints	Lubricate *		•				
		Inspect	U-joint inspections should be performed every time a vehicle comes in for scheduled maintenance. **					
	Models SPL- 140/140HD/170/ 170HD/ 250/250HD Slip Members and U-joints (ON HIGHWAY and LINEHAUL)	Lubricate *				•		
		Inspect	U-joint inspections should be performed every time a vehicle comes in for scheduled maintenance. **					
	Models SPL- 140/140HD/170/ 170HD/ 250/250HD Slip Members and U-joints (OFF HIGHWAY)	Lubricate *	•					
		Inspect	U-joint inspections should be performed every time a vehicle comes in for scheduled maintenance. **					

System	Component	Task	I	A	B	C	D	E
Driveshafts	Models SPL-140XL/ 170XL/250XL Slip Members and U-joints (ON HIGHWAY and LINE HAUL)	Lubricate *	350,000 mi (560,000 km) 1st interval and then every 100,000 mi (160,00 km) after that.					
		Inspect	U-joint inspections should be performed every time a vehicle comes in for scheduled maintenance. **					
	Models SPL-140XL/ 170XL/250XL Slip Members and U-joints (OFF HIGHWAY and CITY)	Lubricate *					.	
		Inspect	U-joint inspections should be performed every time a vehicle comes in for scheduled maintenance. **					
* Use only Spicer Driveshaft approved lubricants when greasing Spicer U-joints. ** Refer to Spicer Driveshaft service manual DSSM-0100 (3264-SPL) for detailed instructions.								

System	Component	Task	I	A	B	C	D	E
Battery Boxes, Tool Boxes, and Steps	Battery Cables	Check the condition of the cables, cushion clamps, nylon tie straps, and routing. Replace a cushion clamp if the rubber has deteriorated. Repair or tighten terminals, and secure cables to prevent chafing. Replace damaged cables (cuts, cracks, or excessive wear); see Batteries on page 231.		.				
	Batteries (ON HIGHWAY and LINE HAUL)	Check for cracks and damage, electrolyte level, condition of terminals, and tightness of holddowns; see Batteries on page 231.				.		
	Batteries (OFF- HIGHWAY)	Check for cracks and damage, electrolyte level, condition of terminals, and tightness of holddowns; see Batteries on page 231.		.				
	Battery Box and Tray (ON HIGHWAY and LINE HAUL)	Check the box integrity. Clean the drain tube and check for acid leaks. Check condition of all equipment mounted under the box.				.		
	Battery Box and Tray (OFF-HIGHWAY)	Check the box integrity. Clean the drain tube and check for acid leaks. Check condition of all equipment mounted under the box.		.				

System	Component	Task	I	A	B	C	D	E	
Battery Boxes, Tool Boxes, and Steps	Battery Cable Fasteners	Check battery cable fasteners and tighten as necessary to 10-15 lb-ft (13.6-20.3 Nm) as specified on the battery label.		•					
Electrical and Lights	Headlamps	Check the aim and adjust as required.				•			
	Warning Lights in Light Bar	Check at the ignition start position to verify bulbs and driver information display function.		•					
	Turn, Stop, Reverse Lights and Signals	Visual check.		•					
	Alternator	Check operation and output.					•		
		Check tightness of the pulley nut.					•		
Check the tension of the drive belt; see Install Engine Belt on page 240.						•			
	Check tightness of the terminal hex nuts.					•			

System	Component	Task	I	A	B	C	D	E
Electrical and Lights	Starter	Check torque on hex nuts.				•		
	ECM Connector	Check the tightness of the ECM connector.				•		
	Wheel Sensors	Check for damaged sensors and connectors, and worn or frayed wires.				•		
	Fuel and Diesel Exhaust Fluid Tank Sending Unit	Check the mounting screws and electrical connections for worn or damaged wires and connectors.	•		•			
	Power Supply Harnesses (engine, Transmission, etc.)	Check for worn or damaged insulation, corroded terminals, frayed wires, and oil or fluid leaks on the connectors or wiring.			•			
Check for worn or damaged insulation, corroded terminals, frayed. Wash to remove excess grease.						•		
Cab Structure, Doors and Hoods	Hood	Lubricate the lower hood pivot (only if lube fittings are present).				•		
	Hinges and Latch	Lubricate with silicone spray.				•		
	Body and Cab Holddown Bolts	Check the condition and tightness.					•	

System	Component	Task	I	A	B	C	D	E
Heating and Air Conditioning	Air Conditioner	Operate the system.		•				
	Heater and Air Conditioner	Perform the checks per <i>Heater and Air Conditioner Maintenance</i> on page 250			•			
		Full operational and diagnostic check.					•	
	Cabin Fresh Air Filter (ON HIGHWAY)	Inspect and clean, replace if necessary.		•				
	Cabin Fresh Air Filter (OFF-HIGHWAY)	Inspect and clean, replace if necessary.		•				
	Condenser	Clear any debris from the front of the condenser.				•		
	Sleeper Air Filter	Inspect and clean, replace if necessary.					•	
	Recirc Cab Air Filter (ON HIGHWAY)	Please contact an authorized dealer when the service interval is required to inspect the cabin recirculation air filter.					•	
Recirc Cab Air Filter (OFF-HIGHWAY)	Please contact an authorized dealer when the service interval is required to inspect the cabin recirculation air filter.					•		

System	Component	Task	I	A	B	C	D	E
Aftertreatment System	System	Check for leaks and proper support; see <i>Noise and Emission Control</i> on page 253.		•				
	Diesel Particulate Filter	Clean filter.	Refer to the Engine Maintenance Manual.					
	Diesel Exhaust Fluid Tank	Inspect the tank, straps, brackets, hoses and fittings for abrasion damage, leaks, tightness and fully engaged connectors.				•		
	Diesel Exhaust Fluid Supply Module	Replace filter.	Refer to the Engine Maintenance Manual.					

System	Component	Task	I	A	B	C	D	E
Air	Air Compressor Governor	Replace air strainer.			.			
	Air Lines	Check condition and routing to prevent chafing.			.			
	System	Lubricate; see What is the Air System? on page 207.				.		
	Inline Filters	Replace elements or clean with solvent.				.		
	Air Dryer	Perform the checks listed; see Air Dryer Maintenance on page 209.			.			
	Air Dryer (ON HIGHWAY)	Replace Cartridge Air Dryer Maintenance on page 209	360,000 miles/576,000 km					
	Air Dryer (OFF HIGHWAY)	Replace Cartridge Air Dryer Maintenance on page 209					.	
	Air Dryer (Oil-Coalescing Desiccant Cartridge)	Replace Cartridge Air Dryer Maintenance on page 209	Annually regardless of mileage					
Engine	Basic Engine	Maintenance and service interval recommendations are detailed in the engine manufacturer's Operations and Maintenance Manual included with the vehicle. The engine manufacturer's recommendations vary depending engine model. Information is also available from authorized dealers, the engine manufacturer's authorized service centers, and the engine manufacturer's web site.						

System	Component	Task	I	A	B	C	D	E
Safety	Three-point Safety Belt System	Inspect.						20,000 miles/32,000km If the vehicle is exposed to severe environmental or working conditions, more frequent inspections may be necessary.

5

New Vehicle Maintenance Schedule

Maintenance tasks to perform in the first 5,000 miles (4,800 km).

Operation/ Frequency	First Day	First 50-100 mi/ 80-160 km	First 500 mi/800 km	First 2,000 mi/3,218 km	First 3,000-5,000 mi/4,800 - 8,000 km
Steering Shaft U-Bolts. (OFF-HIGHWAY)	.				
Wheel Mounting		.			
Front Axle U-Bolt Torque			.		

Operation/ Frequency	First Day	First 50-100 mi/ 80-160 km	First 500 mi/800 km	First 2,000 mi/3,218 km	First 3,000-5,000 mi/4,800 - 8,000 km
Charge Air Cooler and Air Intake Pipe Clamps, re- torque fasteners.			.		
Rear Suspension Fasteners				.	
Transmission Lubrication	See the manufacturer's operator's manual				
Axle Lubrication	See the manufacturer's operator's manual				

Lubricants

In this section you will find the basic information you need to do the routine lubrication your vehicle requires.

Of course you will want to schedule service more frequently if you are operating under severe conditions such as extreme heat or cold, with very heavy loads, off-road, etc. For any special service requirements, consult your service manuals and your lubricant supplier. Please remember: one key to keeping your truck running at top

economy and in prolonging its life is proper lubrication servicing. Neglecting this essential aspect of vehicle care can cost time and money in the long run.



WARNING

Handle lubricants carefully. Vehicle lubricants (oil and grease) can be poisonous and cause death, personal injury or sickness. They can also damage the paint on the vehicle.



CAUTION

DO NOT mix different types of lubricants. Mixing lubricants (oil and grease) of different brands or types could damage vehicle components; therefore, drain (or remove) old lubricants from the unit before refilling it.

Engine

Proper engine lubrication depends on the outside temperatures where you will be driving. Use the oil recommended for the conditions you are most likely to be

operating in. You will find a complete engine lubrication service guide in the Engine Operation Manual that came with your vehicle. The engine operator manual contains specific maintenance tasks that you or a qualified service technician need to perform to maintain the engine.



WARNING

Exhaust fumes from the engine contain carbon monoxide, a colorless and odorless gas. Do not breathe the engine exhaust gas. A poorly maintained, damaged or corroded exhaust system can allow carbon monoxide to enter the cab. Entry of carbon monoxide into the cab is also possible from other vehicles nearby. Failure to properly maintain your vehicle could cause carbon monoxide to enter the cab, resulting in death or personal injury.



WARNING

Never idle your vehicle for prolonged periods of time if you sense that exhaust fumes are entering the cab. Investigate the cause of the fumes and

correct it as soon as possible. If the vehicle must be driven under these conditions, drive only with the windows open. Failure to repair the source of the exhaust fumes may result in death, personal injury, equipment or property damage.



NOTE

Keep the engine exhaust system and the vehicles cab ventilation system properly maintained. It is recommended that the vehicles exhaust system and cab be inspected (1) By a competent technician every 15,000 miles (24,140 km) (2) Whenever a change is noticed in the sound of the exhaust system (3) Whenever the exhaust system, underbody, or cab is damaged.



NOTE

Use only an exact replacement DPF in exhaust systems. Using a noncompliant DPF as a replacement could vio-

late these standards and also void the emission system's warranty.

Transmissions, Axles and Hubs

See the manufacturer's operator's manual for recommended lubrication specifications and maintenance intervals.

Driveline Universal Joints

Refer to the Spicer Universal Joints and Driveshafts service manual and lubrication specifications.

Checking Oil Level

For oil reservoir with side filler plugs (transmission, axles, steering gear boxes, transfer cases, etc.) the oil must be level with the filler opening. Use care when checking the oil level with a finger. Just because you can reach the oil level with a finger, does not mean the oil level is correct.

Improper Oil Level



Correct Oil Level



Inspect Power Steering Fluid

Regularly check the power steering fluid for proper level and fluid condition.

Access the power steering reservoir in the engine compartment. Take all safety precautions when opening the hood.



CAUTION

When adding fluid, be sure to use fluid of the same type. While many fluids have the same description and intend-

ed purpose, they should not be mixed due to incompatible additives. Mixing incompatible fluids may lead to equipment damage.

1. Turn engine off and open hood.
2. Wipe outside of power steering reservoir cover so that no dirt can fall into the reservoir.
3. Verify that the fluid level is at the correct level. Add more fluid if required.
4. Check fluid for air bubbles which may indicate contamination, discoloration, or burnt smell; correct source of such problems before replacing fluid and filter.

If incompatible (insoluble) fluids are mixed in a power steering system, air bubbles can be produced at the interface of the two fluids. This can cause cavitation, which reduces the lubrication between moving parts in the gear. This could result in worn components. The mixture of two different fluids, although harmless to individual internal components, may initiate a chemical reaction that produces a new compound that will attack seals and other internal components. Do not mix different fluids.

What is the Air System?

Important safety information about your vehicle's air system.

The operation of the vehicle's braking system and many vehicle accessories depends upon the storage and application of a high-pressure air supply.



WARNING

Do not attempt to modify, alter, repair or disconnect any component of the air system. Repairs or modifications to the air system, other than what is described in this section, should only be performed by an authorized dealer. Failure to comply may result in death or personal injury.



WARNING

Prior to the removal of any air system component, always block and hold the vehicle by a secure means other than the vehicle's own brakes. Depleting air system pressure may cause the vehicle to roll unexpectedly resulting in an accident causing death or personal injuries. Keep hands away from chamber push rods and slack adjusters, they may apply as system pressure drops.



WARNING

After completing any repairs to the air system, always test for air leaks, and check the brakes for safe operation before putting the vehicle in service. Failure to comply may result in death, personal injury, equipment or property damage.



WARNING

Never connect or disconnect a hose or line containing air pressure. It may whip as air escapes. Never remove a component or pipe plug unless you are certain all system pressure has been depleted. Failure to comply may result in death, personal injury, equipment or property damage.



WARNING

Never exceed recommended air pressure and always wear safety glasses when working with air pressure. Never look into air jets or direct them at anyone. Failure to comply may result in death, personal injury, equipment or property damage.



WARNING

Never attempt to disassemble a component until you have read and understood recommended procedures. Some components contain powerful

springs and injury can result if not properly disassembled. Use only proper tools and observe all precautions pertaining to use of those tools. Failure to comply may result in death, personal injury, equipment or property damage.



WARNING

Completely bypassing a Bendix® ADIS air dryer will bypass the system's pressure protection valves. This could lead to loss of air pressure or damage to the vehicle's air system, which could cause an accident involving death or personal injury. Always adhere to the manufacturer's procedure if it is necessary in an emergency to temporarily bypass an ADIS series air dryer. Failure to comply may result in death, personal injury, equipment or property damage.



WARNING

If a different air dryer brand or model is installed on the vehicle other than what was originally installed, it could cause the air system to not perform correctly unless the full air system design is reviewed and modifications made to comply with Federal Motor Vehicle Safety Standards (FMVSS) 121 AirBrake Systems. Failure to abide by this warning and maintain compliance to FMVSS 121 could cause loss of vehicle control and may lead to death or serious personal injury.



WARNING

If the supply and service air tanks are not drained at the recommended frequency, water could enter the air lines and valves. This could cause corrosion or blockage, which could compromise the brake system safety and potentially cause an accident. Failure to comply may result in death, personal injury, equipment or property damage.

Your vehicle's compressor takes outside air and compresses it, usually to 100-120 psi (689-827 kPa). The compressed air then goes to the reservoirs to be stored until needed. When you operate your air brakes, the stored compressed air flows into the chambers where it is used to apply your truck and trailer brakes. That is why, when you push down on your brake pedal, you don't feel the same amount of pressure on the pedal that you do when you apply the brakes on your car. All you are doing on your truck is opening an air valve to allow air to flow into the brake chambers. Contamination of the air supply system is the major cause of problems in air-operated components such as brake valves, and suspension height control valves. To keep contaminants to the lowest possible level, follow these maintenance procedures.

Daily Checks

- Drain moisture from the supply and service air tanks.
- Operate air devices to circulate lubricants within the unit.

Periodically

- Clean filter screens ahead of the valves by removing the screens

and soaking them in solvent. Blow them dry with pressurized air before reinstalling them.

Twice a Year

- Maintain the air compressor to prevent excessive oil by-pass. See your maintenance manual for details.
- Replace worn seals in valves and air motors as they are needed.

Air Dryer Maintenance

The function of the air dryer is to collect and remove air system contaminants in solid, liquid and vapor form before they enter the brake system. It provides clean, dry air to the components of the brake system, which increases the life of the system and reduces maintenance costs.



NOTE

Because no two vehicles operate under identical conditions, maintenance and maintenance intervals will vary. Experience is a valuable guide in determining the best maintenance interval for any one particular operation.



NOTE

A small amount of oil in the system may be normal and should not, in itself, be considered a reason to replace the desiccant cartridge. Oil stained desiccant can function adequately.

Every 900 operating hours or 25,000 miles (40,200 km) or every three (3) months check for moisture in the air brake system by opening air tanks, drain cocks, or valves and checking for presence of water. A tablespoon of water found in the air tank would point to the need for a desiccant cartridge change. However, the following conditions can also cause water accumulation and should be considered before replacing the desiccant cartridge.

- Air usage is exceptionally high and not normal for a highway vehicle. This may be due to accessory air demands or some unusual air requirement that does not allow the compressor to load and unload (compressing and non-compressing cycle) in a normal fashion or it may be due to excessive leaks in the air system.
- In areas where more than a 30°F (17°C) range of temperature occurs in one day, small amounts of water can accumulate in the air brake system due to condensation. Under these conditions, the presence of small amounts of moisture is normal and should not be considered as an indication that the dryer is not performing properly.
- An outside air source has been used to charge the air system. This air did not pass through the drying bed.

Maintenance



CAUTION

Replace oil-coalescing desiccant air dryer cartridge every 1 year regardless of mileage. Only use oil-coalescing desiccant replacement cartridge when replacing. Failure to perform this maintenance task will void the PACCAR Transmission warranty and may result in expensive transmission damage.

Replace (non-oil-coalescing) desiccant cartridge:

- On-highway operation replace every be 2 - 3 years, 350,000 miles or 10,800 hours.
- High duty cycle usage such as transit bus, refuse hauler, dump truck, cement mixers and off-highway operation replace every 1 year, 100,000 miles or 3,600 hours.



NOTE

Review the warranty policy before performing any maintenance procedures. An extended warranty may be voided if unauthorized maintenance is performed during this period.

Bendix® AD-IS Series Air Dryer

Your vehicle may be equipped with a Bendix® AD-IS series air dryer. Any air dryer replacement should be made with an identical component.



WARNING

Use of an air dryer brand or model that differs from what was originally installed could cause the air system to not perform correctly unless the full air system design is reviewed and modifications are made to comply with Federal Motor Vehicle Safety Standard (FMVSS) 121 Air Brake Systems. Failure to abide by this warning and maintain compliance with FMVSS 121

could cause loss of vehicle control and may lead to death or serious personal injury.

The AD-IS Series air dryer has incorporated into its design various components that have typically been installed separately on the vehicle (see below for components/areas affected):

- Pressure protection valves
- Safety valve
- Governor and plumbing
- Plumbing of the front and rear service air tanks
- Plumbing to accessory systems

These components are required to meet the Federal Motor Vehicle Safety Standards (FMVSS 121 - Air Brake Systems). As the Warning above states, any other type of air dryer installed in the place of an AD-IS Series will require changes, modifications and/or additions to your vehicle's air system to maintain compliance with FMVSS 121.

Air Tanks

Air tanks on the vehicle act as a reservoir for the air system to use without running the air compressor all of the time. These air tanks require maintenance to keep them operational.



WARNING

If the supply and service air tanks are not drained at the recommended frequency, water could enter the air lines and valves. This could cause corrosion or blockage, which could compromise the brake system safety and potentially cause an accident. Failure to comply may result in death, personal injury, equipment or property damage.



CAUTION

DO NOT use penetrating oil, brake fluid, or wax-based oils in the air system. These fluids may cause severe damage to air system components.

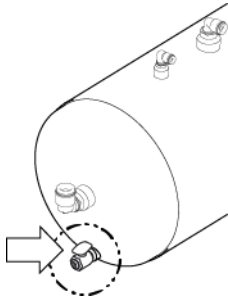

To eject moisture from the air system tanks, pull the line that is connected to the moisture ejection valve. Continue pulling until the air comes out free of water.

Daily

The supply and service air tanks, must be drained on a daily basis. Operate air devices daily to circulate lubricants within the unit.

Periodically

Clean filter screens ahead of the valves by removing the screens and soaking them in solvent. Blow them dry with pressurized air before reinstalling them.

- Maintain the air compressor to prevent excessive oil bypass.

- Replace worn seals in valves and air motors as they are needed. Your authorized dealer carries rebuild kits for most units.

How to Check for Air System Leaks

Use these steps if the air gauges in the dash or any warning lights turn on that indicate that a air leak exists in the system. Checking for air leaks should also be done after any service or repair has been done to the air system.



WARNING

Do not operate the vehicle if leakage in the air system is detected. Conduct the following procedure and contact an authorized dealer (or any other properly equipped service center) if a leak is detected. Failure to check the brakes or follow these procedures could cause a system failure, increasing the risk of an accident and may result in

death, personal injury, equipment or property damage.

1. Build up air pressure in the system to the governor cutout point or until 120 psi (827 kPa) is reached.
2. Stop the engine and release the service brakes.
3. Without applying the brake pedal, observe the rate of air pressure drop. This rate should not exceed 2.0 psi (14 kPa) per minute.
4. Start the engine and build up the air pressure again.
5. Stop the engine, and apply the brakes fully. Apply the brake pedal and hold it down for five minutes. The pressure drop should not exceed 3.0 psi (21 kPa) per minute.
6. If you detect excessive leakage (air pressure loss greater than 3.0 psi (21 kPa) after five minutes of brake application), a leakage test should be made at the air line connections and at all air brake control units.

These tests should determine where air is escaping.

What is an Air Compressor?

Air systems have an air compressor that provides compressed air to the system.

All compressors, regardless of make or model, run continuously while the engine is running. System pressure is controlled by the governor. The governor acts in conjunction with the unloading mechanism in the compressor cylinder block to start and stop compression of air. The compressor is unloaded when the system pressure reaches 120 psi (827 kPa) and compression is reestablished when system pressure falls to 100 psi (690 kPa).

Preventive Maintenance

The following service checks are provided for your information only and should be performed by a certified mechanic. Contact your dealer or the engine manufacturer's Maintenance Manual for further information on servicing air compressors. After completing any repairs to the air system, always test for air leaks, and check the brakes for safe operation before putting the

vehicle in service. Below is a list of areas to maintain for the air compressor:

- Inspect compressor air filter element, if so equipped, and replace element if clogged. Check compressor mounting and drive for alignment and belt tension. Adjust if necessary.
- Remove compressor discharge valve cap nuts and check for presence of excessive carbon. If excessive carbon is found, clean or replace the compressor cylinder head. Also, check compressor discharge line for carbon, and clean or replace the discharge line if necessary.
- Disassemble compressor and thoroughly clean and inspect all parts. Repair or replace all worn or damaged parts, or replace compressor with a factory exchange unit.



CAUTION

When draining the engine cooling system is required, to prevent damage from freezing, the compressor must al-

so be drained at the cylinder head and block. Engine damage could occur if the cooling system is not periodically drained and maintained. See Cooling System for further information.

Brake System

General information about your vehicle's brake system and its components.

To operate your vehicle safely and profitably, you need some understanding of its brake systems. For more on brakes, see the Index, under Brakes.



WARNING

Do not work on the brake system without the parking brake set and wheels chocked securely. If the vehicle is not secured to prevent uncontrolled vehicle movement, it could roll and cause death, serious personal injury or damage to the vehicle.



CAUTION

The air brake system of this vehicle was configured for ONE of the following operations: tractor or truck, and complies with the respective portions of FMVSS 121. A tractor shall not be operated or configured as a truck, nor shall a truck be operated or configured as a tractor, without significant modifications to the air brake system in order to retain compliance with FMVSS 121. Contact your dealer for instructions.



WARNING

Do not use brake linings with a thickness below the specified minimum. Such linings will have lining rivets exposed that can damage the brake drum and reduce brake efficiency, which could cause death, personal injury or system failure.



WARNING

Do not use any replacement part in the brake system unless it conforms exactly to original specifications. A non-conforming part in your vehicle's brake system could cause a malfunction resulting in an accident causing death or personal injury. Sizes and types are so related to one another that a seemingly unimportant change in one may result in a change in how well the brakes work for you on the road. If parts do not work together properly, you could lose control of your vehicle, which could cause a serious accident.

Brake adjustment and brake balance must be set carefully to (1) make the most efficient use of the forces available for braking and (2) allow equal stopping forces at all wheels. Once a brake system is set to specifications, changing any one of its components or any combination of components may cause the system to not work as well. All parts have to work together to perform as they should. Any replacement components in your brake system should be exactly equal to the original components. Any changes from

the original specifications can affect the whole system. All of the following areas are interrelated and must conform to original specifications:

- Tire Size
- Drum brakes
- Cam Radius
- Wedge Angle
- Drum Radius
- Brake Linings
- Brake Chambers
- Slack Adjusters
- Disc Brakes
- Disc Rotors

All vehicle operators should check their brakes regularly.

Air Disc Brakes

This vehicle may have disc brakes instead of drum brakes.

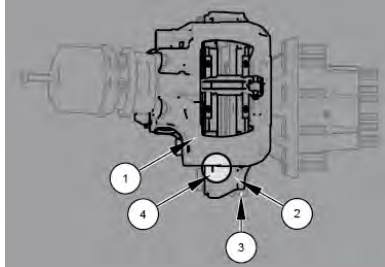

1. Brake Caliper
2. Caliper Mounting Flange
3. Brake Rotor
4. Inspection Notches

How to inspect brake pads on disc brakes

Have brake pads inspected by a qualified mechanic for wear at regular intervals according to the Preventive Maintenance Schedule. In severe service or off-highway applications inspect the linings more frequently.

To inspect the brake pads:

1. Park on level ground and chock the wheels.
2. Temporarily release the parking brakes.
3. Looking from the ground up at the bottom of the caliper and rotor, compare the relative position of two notches; one located on the caliper and the other on the carrier.
4. Take a measurement from between these two notches and compare them to the specifications to determine if the pads need to be replaced.

Have a qualified mechanic perform a detailed inspection if the notches are not found. The pads and rotors should be measured and compared against the manufacturer's specifications located in the brake manufacturer's service manual.

Inspect Disc Brake Caliper for Running Clearance

Running clearance describes the amount of movement between the caliper and the mounting flange.

Regularly inspect caliper for Running Clearance:

1. Stop the vehicle on level ground and let the brakes cool down. Hot

brake calipers can burn skin on contact.

2. Chock the wheels.
3. Temporarily release the parking brakes.
4. Grab the caliper and move it. This movement is Running Clearance.
5. Proper Running Clearance is 0.08 inch (2 mm) of movement of the brake caliper (approximately the thickness of a nickel) in the inboard/outboard direction.

Have a qualified mechanic provide further inspection if the caliper does not move or appears to move more than the specified clearance

Auto Slack Adjuster

The autoslack adjuster is a mechanism to maintain the correct amount of space

between the braking surface and the friction material.

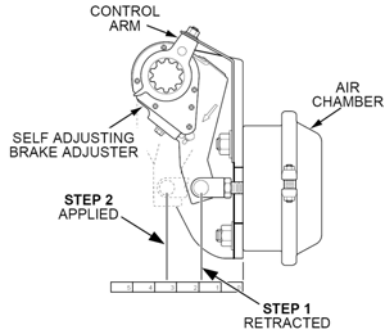

1. Retracted Position, no brake pedal applied
2. Applied Position, brake pedal engaged

Drum Brake Inspection

Important information about checking the brakes.

Have brake drum linings inspected by a qualified mechanic for wear at regular intervals according to the maintenance schedule. In severe service or off-highway applications inspect the linings more

frequently. In addition, periodically check the brake chamber stroke. Replace the slack adjuster if proper stroke cannot be maintained.

Operational checks of automatic slack adjusters

1. Start the vehicle and get the air system up to normal operating pressure. Do not apply the parking brake.
2. Apply pressure to the brake pedal and measure the distance the air chamber pushrod traveled.
3. Compare the results to the specification to determine if the automatic slack adjusters need replacing.



WARNING

Manual adjustment of automatic slack adjusters is a dangerous practice that could have serious consequences. It gives the operator a false sense of security about the effectiveness of the brakes. Contact the Service Department at your dealership if the stroke exceeds specifications. A stroke exceeding specifications may indicate a

problem with the slack adjuster or the brake foundation.

Automatic Slack Adjuster Stroke Specification

Replace the slack adjuster if proper stroke cannot be maintained.

Chamber Type	Stroke
36 (rear brakes)	1 1/2" - 2 1/2" (38-57mm)
30 (rear brakes)	1 1/2" - 2" (38-51 mm)
16,20 and 24 (front brakes)	1" - 1 3/4" (25.4-44.4 mm)

Cab Maintenance

General recommendations for cleaning the exterior and interior of the cab.

Cab exterior and interior components need maintenance to ensure longevity and safe operations.



WARNING

Always allow hot surfaces to cool down before attempting to work near them. Failure to comply may result in death or personal injury.



WARNING

Handle cleaning agents carefully. Cleaning agents may be poisonous. Keep them out of the reach of children. Failure to comply may result in death, personal injury, equipment or property damage.



WARNING

Do not use gasoline, kerosene, naphtha, nail polish remover or other volatile cleaning fluids. They may be toxic, flammable or hazardous in other ways. Failure to comply may result in death, personal injury, equipment or property damage.



WARNING

Do not clean the underside of chassis, fenders wheel covers, etc. without protecting your hands and arms. You may cut yourself on sharp edged metal parts. Failure to comply may result in death, personal injury, equipment or property damage.



WARNING

Moisture, ice, and road salt on brakes may affect braking efficiency. Test the brakes carefully after each vehicle wash. Failure to comply may result in death, personal injury, equipment or property damage.

Vehicle Cleaning

- Observe all caution labels.
- Always read directions on the container before using any product.
- Do not use any solution that can damage the body paint.
- Most chemical cleaners are concentrates that require dilution.

- Only use spot removing fluids in well ventilated areas.
- Any vehicle is subjected to deterioration from industrial fumes, ice, snow, corrosive road salt, etc., to name just a few causes.

Exterior

Wash painted surfaces frequently to remove grime and caustic deposits which may stain the finish.

To prevent rust, keep chromed parts clean and protected with wax at all times, especially in winter conditions where the roads are salted.

- If necessary, use a commercial chrome cleaner to remove light rust.
- Chrome surfaces are best cleaned with fresh water. Wipe dry to preserve their luster. A commercial chrome cleaner will remove light rust. After cleaning, wax flat surfaces and apply a thin coat of rust preventive lubricant around bolts or other fasteners.
- Clean aluminum wheels and bumpers with warm water. Tar remover will get rid of heavy deposits of road grime. To prevent

spotting, wipe aluminum surfaces dry after washing.

- Under corrosive conditions, such as driving on salted roads, clean aluminum parts with steam or high pressure water from a hose. A mild soap solution will help. Rinse thoroughly.

To maintain the tailpipe quality finish, wash the tailpipe with a soft cloth, mild soap and water or glass cleaner. A non-abrasive chrome polish can be used sparingly on hard to clean areas. Do Not clean your high heat chrome using scouring pads, abrasive chrome polish, highly acidic chemical cleaners or any other abrasive cleaners.

Even high quality stainless steel parts can rust under prolonged exposure to salt water, especially when the salt-laden moisture is held against the metal surface by road grime. It is, therefore, important to frequently clean salty moisture and grime from stainless steel surfaces.

- If surface rust is encountered, wash the surface and use a commercial polishing compound to clean off the rust, followed by a coating of wax.
- Never use steel wool when cleaning stainless steel because

minute particles of the steel wool can embed in the surface of the stainless steel and cause rust staining.

Weather Stripping

Frequent washings of the vehicle are required to remove grime and contaminants that can stain and oxidize paint and accelerate corrosion of plated and polished metal surfaces. Waxing offers added protection against staining and oxidation. But to allow enough time for your truck's finish to cure, wait about 30 days after the date of manufacture before waxing. Do not apply wax in the hot sun and do not friction burn the paint with a buffing machine. Occasionally spray weather-stripping on doors and windows with silicone compound to help preserve resiliency. This is especially useful in freezing weather to prevent doors and windows from sticking shut with ice.

Cleaning Interior Vinyl and Upholstery



NOTE

Strong cleaning agents such as hand sanitizer, solvents, paint thinners, window cleaner and gasoline/ diesel fuel must never be used on your vehicle's interior. Repeated exposure to chemicals such as sunscreen, insect repellents containing DEET, or brake fluid may cause accelerated wear, tackiness or discoloration of interior surfaces.

Wipe vinyl upholstery and lining with a good commercial upholstery cleaner. Do not use acetone or lacquer thinner. Clean fabric upholstery with upholstery shampoo specially formulated for this purpose.

- First remove loose dirt, dust or debris with a vacuum cleaner.
- Use a soft brush to loosen caked on dirt before vacuuming it away.
- Wipe the fabric surface with a slightly damp cloth and dry the seat fabric thoroughly. If the fabric is still dirty, wipe using a mixture of mild

soap and lukewarm water, then dry thoroughly.

- If the stain does not come out use an upholstery shampoo specially formulated for this purpose. Test the cleaner on a hidden place to make sure it does not affect the fabric adversely. Follow the instructions on the container.

Other interior surfaces may be cleaned using a mixture of mild soap and lukewarm water or an automotive interior cleaner, used on its intended surface (i.e. use leather conditioner on leather surfaces, etc.).

Avoid frequent or repeated use of the following products on interior surfaces:

- Alcohol-based cleaners (including hand sanitizer)
- Methanol-based cleaners
- Bleach
- Acetone
- Any other strong solvent
- Abrasive cleaners
- Sunscreen

How to Wash the Exterior of the Vehicle

A well-cared-for vehicle can look like new many years later. Regular and correct care will contribute to maintaining the beauty and the value of your vehicle. Your dealer has a number of vehicle-care products and can advise you on which ones to use for cleaning the exterior and interior of your vehicle.

	WARNING
<p>Handle cleaning agents carefully. Cleaning agents may be poisonous. Keep them out of the reach of children. Failure to comply may result in death, personal injury, equipment or property damage.</p>	

	WARNING
<p>Do not use gasoline, kerosene, naphtha, nail polish remover or other volatile cleaning fluids. They may be toxic, flammable or hazardous in other ways. Failure to comply may result in death,</p>	

<p>personal injury, equipment or property damage.</p>

	WARNING
<p>Do not clean the underside of chassis, fenders wheel covers, etc. without protecting your hands and arms. You may cut yourself on sharp edged metal parts. Failure to comply may result in death, personal injury, equipment or property damage.</p>	

	WARNING
<p>Moisture, ice, and road salt on brakes may affect braking efficiency. Test the brakes carefully after each vehicle wash. Failure to comply may result in death, personal injury, equipment or property damage.</p>	



CAUTION

DO NOT aim the water jet directly at door locks or latch. Tape the key holes to prevent water from seeping into the lock cylinders. Water in lock cylinders should be removed with compressed air. To prevent locks from freezing in the winter, squirt glycerin or lock deicer into the lock cylinders.



NOTE

To allow enough time for your truck's finish to cure, wait at least thirty days after the date of manufacture before waxing.

1. Begin by spraying water over the dry surface to remove all loose dirt before applying the car wash and wax solution.
 - Do not wash the vehicle in direct sunshine.
 - Do not spray water directly into the cab vents.
2. Using soapy water, wash the vehicle with a clean soft cloth or a

soft brush made for automotive cleaning.

- Use cool or warm water and a mild, household type soap. Strong industrial detergents and cleaning agents are not recommended.
 - Do not use stiff brushes, paper towels, steel wool, or abrasive cleaning compounds because they will scratch painted, plated, and polished metal surfaces.
3. Rinse surfaces frequently while washing to flush away dirt that might scratch the finishes during the washing operation.
 4. Hose dirt and grime from the entire chassis.

If an oil leak develops, you will be able to detect it easier.

Corrosive materials used for ice and snow removal and dust control can collect on the underbody. If these materials are not removed, accelerated corrosion (rust) can occur on underbody parts such as fuel lines, frames, floor pan, and exhaust system, even though they have been provided with corrosion protection.

At least every spring, flush these materials from the under body with plain water. Be

sure to clean any area where mud and other debris can collect. Sediment packed in closed areas of the frame should be loosened before being flushed. If desired, your dealer can do this service for you.

5. Wipe everything dry with a chamois to avoid water spots. To prevent water spotting, dry off the cosmetic surfaces with a clean cloth or chamois.
6. Remove road tar with an automotive type tar remover or mineral spirits.
7. After cleaning and drying, apply a quality automotive wax.

Care of Display Screens on the Dashboard

From time to time it may be necessary to clean the display screen.

To clean the screen, dampen a clean, soft, lint-free cloth with water only. A mild glass cleaner that does not contain alcohol or ammonia may also be used. Cleaners that contain alcohol and/or ammonia will eventually dry-out, crack and "yellow" the screen. Wipe the screen gently back and forth. You can also use a commercial

cleaner especially designed for LCD screens.

Safety Restraint System - Inspection

The seat belt system, including webbing, buckles, latches, and mounting hardware, endures heavy use in heavy-duty vehicles, much more than seat belt systems in passenger cars. All users should be aware of the factors contributing to this heavy use and reduced belt life.



WARNING

Failure to properly inspect and maintain restraint systems can lead to injury or loss of life. Without periodic inspection and maintenance to detect unsafe conditions, seat restraint components can wear out or not protect you in an accident.



WARNING

It is important to remember that any time a vehicle is involved in an accident, the entire seat belt system must be replaced. Unexposed damage caused by the stress of an accident could prevent the system from functioning properly the next time it is needed. Failure to comply may result in death or personal injury.

Seat Belt Inspection Points

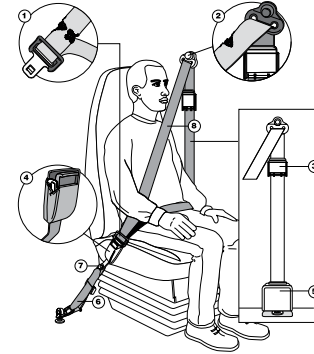

1. Web cut or frayed or extremely worn at latch area.
2. Web cut or frayed at D-loop web guide.
3. Comfort Clip cracked or damaged.
4. Buckle casting broken.
5. Retractor Web Storage for damage. (located behind trim panel)
6. Tethers for web wear and proper tightness of mounting hardware.

- 7. Mounting hardware for corrosion, proper tightness of bolts and nuts.
- 8. Web for deterioration, due to exposure to the sun.

Factors contributing to reduced seat belt life:

- Heavy trucks typically accumulate twice as many miles as the average passenger car in a given time period.
- Seat and cab movement in trucks causes almost constant movement of the belt due to ride characteristics and seat design. The constant movement of the belt inside the restraint hardware and the potential for the belt to come in contact with the cab and other vehicle parts, contributes to the wear of the entire system.
- Environmental conditions, such as dirt and ultraviolet rays from the sun, will reduce the life of the seat belt system.

Due to these factors, the three-point safety belt system installed in your vehicle requires thorough inspection every 20,000 miles (32,000 km). If the vehicle is exposed to severe environmental or working conditions, more frequent inspections may

be necessary. Any seat belt system that shows cuts, fraying, extreme or unusual wear, significant discoloration due to UV (ultraviolet) exposure, abrasion to the seat belt webbing, or damage to the buckle, latch plate, retractor hardware or any other obvious problem should be replaced immediately, regardless of mileage.

Inspection Guidelines

Follow these guidelines when inspecting for cuts, fraying, extreme or unusual wear of the webbing, and damage to the buckle, retractor, hardware, or other factors. Damage to these areas indicates that belt system replacement is necessary.



WARNING

Replace the entire belt system (retractor and buckle side) if replacement of any one part is necessary. Unexposed damage to one or more components could prevent the system from functioning properly the next time it is needed. Failure to comply may result in death or personal injury.

1. Check the web wear in the system. The webbing must be closely

examined to determine if it is coming into contact with any sharp or rough surfaces on the seat or other parts of the cab interior. These areas are typical places where the web will experience cutting or abrasion. Cuts, fraying, or excessive wear would indicate the need for replacement of the seat belt system.

2. The pillar web guide (D-loop) is the area where almost constant movement of the seat belt webbing occurs because of relative movement between the seat and cab.
3. Check the Komfort-Latch for cracks or possible damage and check for proper operation.
4. Check buckle and latch for proper operation and to determine if latch plate is worn, deformed, or damaged.
5. Inspect the retractor web storage device, which is mounted on the floor of the vehicle, for damage. The retractor is the heart of the occupant restraint system and can often be damaged if abused, even unintentionally. Check operation to ensure that it is not locked up and

- that it spools out and retracts webbing properly.
6. If tethers are used, be sure they are properly attached to the seat and, if adjustable, that they are adjusted in accordance with installation instructions. Tethers must also be inspected for web wear and proper tightness of mounting hardware.
 7. Mounting hardware should be evaluated for corrosion, and for tightness of bolts and nuts.
 8. Check web in areas exposed to ultraviolet rays from the sun. If the color of the web in these areas is gray to light brown, the physical strength of the web may have deteriorated due to exposure to the sun's ultraviolet rays. Replace the system.

Once the need for replacement of the seat belt has been determined, be certain it is only replaced with an authorized PACCAR Parts replacement seat belt. If the inspection indicates that any part of the seat belt system requires replacement, the entire system must be replaced. An installation guide is attached to every replacement belt. Utilize the proper guide for your type of seat, and follow the

instructions very closely. It is vitally important that all components be reinstalled in the same position as the original components that were removed and that the fasteners be torqued to specification. This will maintain the design integrity of the mounting points for the seat belt assembly. Contact your dealer if you have any questions concerning seat belt replacement.

Cooling System Maintenance

Information about concentration and condition of coolant, including filter.

The cooling system in your vehicle was factory filled with extended life coolant that meets or exceeds all ASTM D6210 and Caterpillar EC-1 requirements. PACCAR recommends only using a 50/50 mixture of distilled water and ELC when cooling system service is required. A 50/50 mixture of ELC and distilled water will provide freeze protection down to -34°F (-36.7°C), which is adequate for most locations in North America. For extremely cold operating conditions, a 60/40 mixture (coolant/water ratio) can be used to

provide freeze protection down to -62°F (-52.2°C).

Unless otherwise optioned, factory fill coolant is an ethylene glycol, nitrated organic acid technology (NOAT) extended life coolant (ELC) formulation at a 50:50 coolant-to-distilled water mixture. The factory fill exceeds ASTM D6210 and Caterpillar EC-1 requirements. Maintaining coolant chemistry and freeze protection is critical to engine and cooling system component health and longevity.



WARNING

Coolant is toxic. DO NOT get the fluid in eyes. If contact occurs, flood eyes with large amounts of water for 15 minutes. Avoid prolonged or repeated contact with skin. In case of contact, immediately wash skin with soap and water. DO NOT take internally. If swallowed, seek immediate medical attention. DO NOT induce vomiting. Failure to comply may result in death, personal injury, equipment or property damage.



CAUTION

The engine cooling system has very specific maintenance and inspection requirements. Failure to follow requirements can damage the engine. Engine damage can include but is not limited to freezing, boiling, corrosion, pitted cylinder liners. This information is found in the engine manufacturers owner's manual. It is the owner's responsibility to follow all requirements listed in the engine manufacturers owner's manual.



CAUTION

Use of non-genuine coolant filters can cause severe engine damage.

Concentration

Check the level of freeze/boilover protection, which is determined by the glycol concentration. Use a glycol refractometer to determine glycol level. Add coolant to obtain the coolant/water ratio required to provide the protection you need. A 50/50 mix of coolant and water is adequate for most applications. For extremely cold operating conditions, the ratio can be adjusted to a higher concentration of coolant.



NOTE

Coolant is harmful to the environment. Unused coolant must be stored as a toxic hazardous material in leakproof containers. Used coolant must be processed as industrial chemical waste. Please follow HAZMAT guidelines with both used and unused coolants.



NOTE

Maximum recommended ELC concentration is 60% ELC and 40% water by volume (a 60/40 coolant mixture). The minimum recommended concentration is 40%.

Glycol Concentration Level

Level	Desired Coolant / Water Ratio	Freeze Point °F (°C)
Recommended Levels	40%	-12 (-24)
	45%	-23 (-31)
	50%	-34 (-37)
	55%	-50 (-46)
	60%	-62 (-52)

Condition

Perform a visual inspection of the coolant. It should have no cloudiness or floating debris. Determine the chemical inhibitor concentration level by using an extended life coolant specific test kit or test strips. Inhibitor concentration level determines corrosion protection. If you are concerned about possible coolant quality, contamination, or mechanical problems, submit a coolant sample for analysis. Improper maintenance may cause coolant

degradation and could result in damage to the cooling system and engine components. Consult your dealer or the coolant manufacturer's representative for recommended extended life coolant test kits, test strips, and laboratory sample procedures.

Coolant Extender

Add extended life coolant extender, if necessary, according to the corrosion inhibitor concentration required. DO NOT add coolant extender to nitrite-free coolant.

Checking Coolant Level

Check the coolant level daily. When adding coolant, avoid mixing different brands and formulations. If the coolant is mixed with more than 25% of a different formulation, engine corrosion damage could occur. If mixing exceeds 25% of total system volume, it is recommended to flush and refill the system completely with one type of coolant.

Coolant Filter

Your engine is equipped with a coolant filter designed to capture and remove harmful deposits from the cooling system to help prolong system life. It is a "blank filter" and does not contain chemicals or

time-release additives. Replace it only with a blank filter at the interval specified in the Preventative Maintenance Schedule. Never use filters that contain supplemental coolant additives (SCAs) in an ELC-filled system.



CAUTION

Use of non-genuine coolant filters can cause severe engine damage.

Cooling System Sealing Additives and Soluble Oils

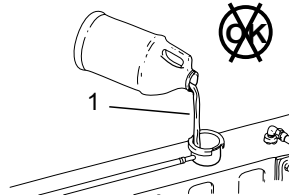

1. Do not use soluble oils or sealing additives.



CAUTION

The use of sealing additives or soluble oils in the cooling system can cause damage to the engine. These additives can plug various areas of the radiator, EGR system and oil cooler. The plugging of the cooling system can hamper heat transfer, causing internal engine damage. Do not use sealing additives or soluble oils in the cooling system. The use of sealing additives can:

- Build up in coolant low-flow areas.
- Plug the radiator and oil cooler.
- Damage the water pump seal.
- Damage heat transfer surfaces.
- Damage seals and hoses.
- Corrode brass and copper.

Failure to comply may result in equipment or property damage.

Inspect Coolant Level

Inspect the vehicle's coolant surge tank for proper coolant level. Add coolant if the

level in the tank is below the line marked **MIN**.

The minimum fluid level is determined by the line on the surge tank indicated by the letters "MIN". This indicator is located below the fill cap. The cooling system will need fluid if the surge tank level does not rise to the "MIN" line regardless if the system is hot or cold.

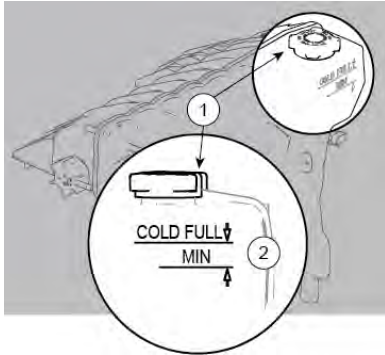

1. Fill location
2. Fill line

How to Add Coolant to the Cooling System

Add coolant through the surge tank fill cap. Do not remove the pressure cap to fill the cooling system.

WARNING

Do not remove the radiator fill cap while the engine is hot. Scalding steam and fluid under pressure may escape. You could be badly burned. Failure to comply may result in death or personal injury.

NOTE

If frequent topping off is necessary and there are no visible signs of coolant leaks when the engine is cold, check for leaks with the engine operating at normal temperature.

NOTE

Do not use the pressure cap to fill the surge tank with fluid.

NOTE

Do not overfill a cooling system. Excess coolant may result in overflow, loss of antifreeze, and reduced corrosion protection.

1. If your cooling system is built with drain valves in the upper engine coolant pipe, open them before filling the surge tank.
2. Close any open coolant drains in the system.
3. Remove the surge tank fill cap (do not remove the surge tank pressure cap).
4. Fill the system with premixed coolant through the surge tank fill cap. Pour coolant at a steady flow rate until the surge tank is full (to the base of the fill neck). It may be necessary to pause for 1 minute and then re-fill if the fluid level dropped.
5. Close any drain valves that were opened in Step 1.
6. Start the engine and idle at low rpm.

7. During low rpm idle, air will purge from the cooling system which will lower the coolant level in the surge tank. Continue to fill the surge tank until the coolant level remains approximately ½ in. above the "MIN" line. This may take up to 2 minutes, depending on the outside temperature.
8. Operate the engine throttle until the operating temperature stabilizes (when the thermostat opens).
9. Fill the surge tank as necessary to raise the coolant level to ½ in. above the "MIN" level.
10. Operate the engine at high idle for another 10 minutes and then fill the surge tank again to ½" above the "MIN" level.
11. Replace the surge tank fill cap.

Check the coolant level after each trip. Add coolant as necessary. You may find your coolant level is not up to the correct level soon after you have filled the radiator. This may be because all the trapped air in the system has not yet been purged. It takes a little time for all of the air to leave the system after you fill your radiator. Use a solution of half ethylene glycol antifreeze and half water for best heater

performance. Do not use more than 65 percent concentration of antifreeze, as a shortened heater life will result. After servicing the cooling system, operate the vehicle for a day or two before using the heater. Trapped air inside the engine needs time to escape.

Extended Life Coolant

Information on using Extended Life Coolant (ELC).

Perform these maintenance procedures according to the Preventative Maintenance Schedule.

- Conduct coolant maintenance checks including freeze point, pH, nitrite and carboxylate tests at least twice annually to maintain engine protection.

Nitrited Extended Life Coolant

For nitrited formulations (NOAT), a heavy-duty extended life coolant that meets ASTM D6210 and Caterpillar EC-1 specifications must be used.

The change interval for extended-life coolant containing nitrite and molybdate is 750,000 miles (1,200,000 km) or 12,000 hours of on-road use (8 years or 15,000 hours of off-highway use) on initial fill with

no extender added. The change interval is 1,000,000 miles (1,600,000 km)/20,000 hours/8 years with an extender addition at 500,000 miles (800,000 km)/10,000 hours/4 years.

Nitrite-Free Extended Life Coolant

Nitrite-free organic acid technology coolant (OAT) may be used if it meets DAF 74002. The change interval for nitrite free coolant is 600,000 miles (1,000,000 km) or 6 years, with no extender needed. DO NOT add coolant extender to nitrite-free coolant. Follow the coolant supplier's drain/flush/fill/diluting percentages when servicing a vehicle filled with nitrite-free coolant.

Additional Recommendations:

- Antifreeze is essential for freeze, overheat, and corrosion protection. The use of supplemental coolant additives (SCAs) is not recommended for extended-life coolants.

Recommended Extended Life Coolant Suppliers

Authorized PACCAR Engine dealer



Windshield Wiper/Washer

The windshield wiper system is maintenance free. Check wiper blades annually or every 60,000 miles (96,000 km).



CAUTION

DO NOT use antifreeze or engine coolant in the windshield washer reservoir, damage to seals and other components will result.

Washer Reservoir

Daily: Check reservoir water level, located in the engine compartment. If necessary, refill to the proper level.

Electrical System



WARNING

Battery posts, terminals and related accessories contain lead and lead

compounds, chemicals known to the State of California to cause cancer and reproductive harm. Wash hands after handling.



WARNING

Before attempting any work on the batteries or electrical system, remove all jewelry. If metal jewelry or other metal comes in contact with electrical circuits, a short circuit may occur causing you to be injured, as well as electrical system failure and damage.



CAUTION

DO NOT modify or improperly repair the vehicles electrical system or power distribution box. All electrical repairs should be performed by an authorized dealer. Improper repair or modifications will void your warranty and/or cause serious damage to your vehicle.

Aftertreatment System Power Requirements

The aftertreatment system uses battery power for up to 10 minutes after the ignition is turned off. After the ignition turns off, the aftertreatment system circulates DEF to help cool down the fluid and prevent overheating. For situations where the battery will be disconnected (ie for service or maintenance of the vehicle), please wait 10 minutes before disconnecting battery power.



CAUTION

Wait at least 10 minutes after the key switch is turned OFF before disconnecting battery power. The system uses battery power to circulate DEF and prevent overheating of the DEF system. Failure to comply may result in equipment or property damage.

What is Low Voltage Disconnect?

General information on low voltage disconnect.

The LVD may increase battery life and prevent unnecessary jump start conditions by ensuring that an unattended load does not deplete the battery charge to a level

that will prevent you from starting your vehicle.

WARNING

Do not use the Spare Battery A and B circuits or other circuits that are controlled by the LVD to power electronic engine controls, ABS circuits, or safety/work related lighting. Before adding any device to the vehicle's electrical system, consult your nearest authorized dealer or read the contents of TMC RP136. Failure to do so may cause equipment damage or lead to personal injury.

NOTE

The determination of what circuits/loads that were connected to the LVD was based upon the recommendation from Technology and Maintenance Council (TMC) of the American Trucking Association. To review the recommended practice, see TMC RP-136.

The LVD will disconnect non-vital battery loads when battery voltage drops below

12.2V for 2 minutes and the key switch is in the ACC or OFF position. During the next 30 seconds, the LVD will flash the Battery Disconnect Telltale in the Driver Information Display. As the telltale flashes an audio warning will also sound. During the last 2 minutes the LVD will emit a slow audible beep. After 2 minutes of flashing the warning on the DPC, the LVD will shut-off any circuit connected through the LVD system. Even if the ignition switch is cycled OFF and ON again, the LVD will continue to fault until it sees battery voltage at, or above, 12.2V.

Circuits Disconnected By LVD

- Cab Dome Lamps
- Cab Accessories
- Spare LVD wiring for customer added accessories

NOTE

All LVD circuits are color-coded blue on the central electrical panel cover label.

How to Replace Headlamp Bulb

Replacing a headlight bulb is accomplished by accessing the rear of the headlight via a access panel in the front fender. Open the hood to get access to this panel.

Access Door

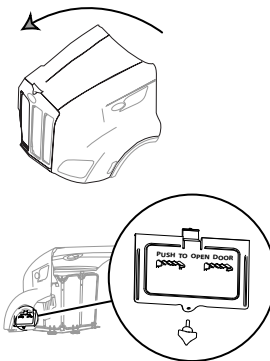

1. Park the vehicle and apply the parking brakes
2. Open the hood and secure it in the open position
3. Locate and open the access panel on the inside of the fender well

- Find the lock ring for the headlamp bulb holder, twist counter clockwise to loosen and pull out the holder and bulb



WARNING

Optional HID headlights have high voltage circuits and should only be serviced by a trained technician. Attempting to service the HID ballast without proper training may result in severe electrical shock which could lead to death or personal injury.

Do not touch the surface of the light bulb. The glass could become contaminated and cause bulb failure.

Vehicle Light Bulb specifications

Bulb Location	Type of Bulb	Notes
Low Beam Halogen	H11-LL (SAE), H7 (ECE)	(long life version not required)
Low Beam HID	D1-S	

Bulb Location	Type of Bulb	Notes
High Beam Halogen	HB3A – LL	(long life version not required)
Daytime Running Lamp/ Position Lamp/Turn Signal/ Side Marker	4157K (SAE), 3157K (ECE)	
Rear tail light/ Turn Signal	N/A	LED lighting
Interior map/ dome/ indirect light	N/A	LED lighting

Aiming Headlights

Please have an authorized dealership aim the headlights.

The headlights were properly aimed at the factory to meet safety specifications. If the headlights need to be adjusted, please

have an authorized dealership aim the headlights.

Fuses, Circuit Breakers and Relays

Fuse information for both cab and sleeper.

Fuses, circuit breakers, and relays are located in the Power Distribution Center (PDC) to the left of the steering column, behind the clutch pedal. Additional fuses are located in the engine compartment (driver's side firewall) and also in the sleeper (driver's side of vehicle) under the bunk storage compartment. Refer to the fuse labels affixed at each fuse panel location (generally under the fuse panel cover) for information about the location and amp ratings of each circuit.

Altering the Electrical System

Refer to a wiring diagram for your chassis before adding electrical options to ensure proper electrical system performance.

 **WARNING**

Do not replace a fuse with a fuse of a higher rating. Doing so may damage the electrical system and cause a fire. Failure to comply may result in death, personal injury, equipment or property damage.

 **WARNING**

Never install a circuit breaker/poly-switch in a location indicated for “fuse only.” Using a polyswitch (circuit breaker) in a fuse-only circuit may cause the circuit to overheat when a short exists, which could lead to equipment damage and/or personal injury.

 **NOTE**

Polyswitches/circuit breakers are allowed in certain locations as indicated

by the label on the fuse box. In these applications, a fuse may be used instead of a circuit breaker.

 **CAUTION**

Follow all manufacturers' circuit protection recommendations for the components and wires being added. Failure to comply may result in equipment damage.

 **NOTE**

If you are unfamiliar with proper electrical repair practices and procedures, see your authorized dealer for assistance.

Batteries

Information on maintaining your vehicle's batteries.

Regular attention to the charging system will help prolong the service life of the batteries.

 **WARNING**

Batteries contain acid that can burn and gasses that can explode. Ignoring safety procedures may result in death, personal injury, equipment or property damage.

 **WARNING**

Never remove or tamper with battery caps. Ignoring this could allow battery acid to contact eyes, skin, fabrics, or painted surfaces. Failure to comply may result in death, personal injury, equipment or property damage.

 **WARNING**

Replace only with AGM (Group 31) batteries. Use of other batteries could result in acid leaks causing personal injury in the event of a vehicle accident. Failure to comply may result in death, personal injury, equipment or property damage.



WARNING

Battery cables and air/electrical harnesses are mounted to the bottom of the floor. Do not drill or screw into floor pan without first checking the location of the cables, harnesses or any other component that might be damaged. Damaging any component could result in electrical shock which could cause personal injury and/or loss of a critical truck system. Failure to comply may result in death, personal injury, equipment or property damage.



WARNING

Electrical damage or battery explosion can occur when improperly charging batteries. Failure to comply may result in death, personal injury, equipment or property damage.



WARNING

Batteries release gases that are flammable. Batteries are equipped with

vent tubes and flash arrestors which vent battery gases out of the cab. Ensure all vent tubes, flash arrestors and grommets are properly installed and ensure they are clear and functioning properly. Failure to reinstall or keep the vent tubes and grommets clear or ensure the flash arrestor(s) are functioning properly could result in death, personal injury, equipment or property damage.



CAUTION

DO NOT store other items in the battery box. Failure to comply could result in damage to the truck and/or batteries.



CAUTION

Properly secure battery tie downs and battery box cover when reinstalling batteries after service. DO NOT over tighten. Over tightening can crack the battery case which can lead to equipment damage.



CAUTION

The Diesel Exhaust Fluid (DEF) system purges to prevent damage from freezing. If your vehicle is equipped with battery disconnect switches, DO NOT disconnect battery power within two minutes of switching the ignition key off. Failure to comply may result in vehicle or property damage.

Here are some common causes of battery failure:

Overcharge: this condition results from improper voltage regulator adjustment. It results in overheating of the battery, warped plates, and evaporation of electrolyte.

Undercharge: the voltage regulator is malfunctioning, the drive belt is slipping, or your vehicle has undergone long periods of standing idle or short distance driving.

These conditions result in battery plates becoming covered with a hard coating.

Vibration: loose battery hold-downs may cause battery plate failure.

Short Circuits: these discharge the battery by draining electricity.

Dirty or Loose Connections: improper connections may stop the flow of electrical power to and from the battery.

Battery Charging



WARNING

Batteries can injure you severely. They contain acid, produce poisonous and explosive gases, and supply levels of electric current high enough to cause burns. A spark or flame near a battery on charge may cause it to explode with great force. Never remove or tamper with the battery caps. Failure to comply may result in death, personal injury, equipment or property damage.

Except for using small trickle charges to maintain battery condition, you should have your vehicle's batteries charged by a qualified service facility. To help reduce the risk of personal injuries, follow these guidelines carefully when recharging a battery:

- Before attempting any service in the electrical installation, disconnect the battery negative cable.

- Allow no sparks or open flame anywhere near the charging area.
- Charge a battery only in a well-ventilated area, such as outdoors or in a fully open garage which contains no pilot lights or other flames. Gases generated during the charging process must be allowed to escape.
- Always make sure the battery charger is OFF before connecting or disconnecting the cable clamps.
- To avoid short circuits, damage to the vehicle, or personal injury, never place metal tools or jumper cables on the battery or nearby. Metal that accidentally comes in contact with the positive battery terminal or any other metal on the vehicle (that is in contact with the positive terminal), could cause a short circuit or an explosion.
- Never attempt to place the vehicle in motion, or run the engine with batteries disconnected.
- Keep the battery clean and dry.
- Look for any signs of damage.
- Battery terminals should not be coated with improper grease. Use petroleum jelly or commercially available, noncorrosive, nonconductive terminal coatings.
- Never use a fast charger as a booster to start the engine. This can seriously damage sensitive electronic components such as relays, radio, etc., as well as the battery charger. Fast charging a battery is dangerous and should only be attempted by a competent mechanic with the proper equipment.

Charging Reminders

- Use protective eyewear.
- Keep all batteries away from children.
- Never reverse battery poles.

Under Cab Battery Access

The vehicle is originally equipped with three or four batteries. These procedures apply to batteries that are located in the under cab access step battery box.

The battery compartment is located on the left side of the vehicle, under the cab access steps.

1. Remove the 6 bolts that are located in the 2 cab access step plate.
2. Remove battery cover for access.

In Cab Battery Access

Your vehicle may be equipped with Absorbed Glass Mat (AGM) batteries located in the cab under the passenger's seat. The glass mat in AGM batteries are designed to absorb the battery acid inside the battery that can leak or spill out in conventional batteries. This design feature allows batteries to be positioned in any orientation without risk of leaking.

To access the batteries:

1. Enter the cab
2. Remove 6 fasteners securing the passenger side seat base to the battery box assembly.
3. Remove the seat and seat base as one unit to gain access to the batteries.

Cranking Battery Specification

Replacement batteries must meet the following specifications.

Category	Specification
General	Maintenance free
Group	31
Stud Type	Thread
Cold Crank Amp	650
Voltage	12V
Reserve Capacity	160 minutes

Removing Batteries

Information on removing batteries.

After accessing the battery, these steps can be used to remove them from the vehicle.

1. Be sure all switches on the vehicle are turned OFF.
2. Wait 2 minutes after turning ignition off then disconnect negative ground cable first.
3. Disconnect positive cable.
4. Unscrew the holding plate bolts with open end wrench.



NOTE

Always dispose of automotive batteries in a safe and responsible manner. Contact your authorized dealer for disposal standards. Call your local authorized recycling center for information on recycling automotive batteries.

Follow the procedures below to reinstall batteries on the vehicle and replace parts removed for access.

Installing Batteries

Follow the procedure below to reinstall main batteries on the vehicle:



NOTE

Always dispose of automotive batteries in a safe and responsible manner. Contact your authorized dealer for disposal standards. Call your local authorized recycling center for information on recycling automotive batteries.



NOTE

Make sure to reconnect the ground (negative) cable last.



WARNING

Battery replacement may alter or disturb battery cable routing. Check to insure battery cables are free from any point of chaffing. Failure to comply may result in death, personal injury, equipment or property damage.

1. Place batteries in vehicle and tighten bolt of holding plate.
2. Reconnect positive cable.
3. Reconnect ground (negative) ground cable.

Replace Battery Box Cover

Certain parts must be reinstalled when accessing the under cab battery box.



WARNING

Always reinstall steps before entering the cab or accessing the deck plate. Without steps you could slip and fall. Failure to comply may result in personal injury or death.



WARNING

Fairings not installed properly could come loose and cause other motorists to have an injury accident. It is important that fairings be installed properly. Failure to comply may result in death, personal injury, equipment or property damage.

1. Replace battery cover.
2. Install 2 bolts in step strut. Torque to 24-32 lb-ft (33-43 Nm).
3. Install fairing and install 4 bolts. Torque to 6-7 lb-ft (8-9 Nm).
4. Install steps by installing 2 bolts in each step. Torque to 24-32 lb-ft (33-43 Nm).

Slow Battery Charging

A slow trickle charge is recommended for optimum performance from the batteries.



WARNING

Charger cables must be connected positive to positive (+ to +) and negative to negative (- to -). If connected improperly, batteries could explode. Failure to comply may result in death, personal injury, equipment or property damage.



WARNING

Always make sure the battery charger is OFF before connecting or disconnecting the cable clamps. To reduce the danger of explosions and resulting death or personal injury, do not connect or disconnect charger cables while the charger is operating.



NOTE

Some vehicles may have an ultra capacitor mounted in the battery box. These devices have a similar shape to a battery but have two positive posts and one negative posts. Do not attach battery chargers to these devices to recharge the vehicles batteries. Connect directly to the conventional two post charging batteries to charge them.



NOTE

Follow the instructions that come with your battery charger.

1. Access the battery terminals, the batteries do not have to be removed from the vehicle.
2. Make sure the battery charger is turned off.
3. Disconnect the battery cables.
4. Connect charger cables.
5. Start charging the battery at a rate not over 6 amperes. Normally, a battery should be charged at no

more than 10 percent of its rated capacity.

6. After charging, turn OFF charger and disconnect charger cables.

Alternator

Take the following precautions to avoid burning out alternator diodes:

- Do not start the engine with alternator disconnected (connections removed) from the circuit.
- Before welding, disconnect all electronic connections to the vehicle batteries.
- Remove battery power cable and insulate it from the vehicle.
- Do not run the engine with the batteries disconnected.
- Do not disconnect the battery cables or alternator connection cables with the engine running.
- Never turn the ignition switch from the ON position to the START position with the engine running.
- When charging the battery (installed in the vehicle) disconnect the battery cables.

- Do not reverse the cables of the alternator, starter motor, or battery.
- Do not polarize the alternator. The alternator should not be polarized like a generator. To ensure correct polarity, use a test lamp or a voltmeter.

Remote Keyless Entry

The remote keyless entry system may become inoperational due to a key fob battery.

If you have issues with a key fob, replace the battery and re-synchronize the key fob. In some situations, the key fob may need to be replaced and in others, a fuse may have failed and may render both key fobs inoperative. Contact your dealer for more help if a key fob does not work and it is not because of a bad battery.

Related concepts

Remote Keyless Entry Key Fob Battery

Batteries should last approximately three years, depending on use. Consistently reduced range is an indicator that the battery needs replacement.

Quantity	Type
1	CR2032

Synchronize Key Fob

How to synchronize the key fob.

The key fob may need to be synchronized to the truck when the battery is replaced or when the key fob has not been used for an extended period of time.

1. Hold the key fob near the passenger door.
2. Press and hold both the **LOCK** and **UNLOCK** buttons at the same time for approximately seven seconds.

When the key fob is resynchronized, the doors will lock then immediately unlock. If the fob fails to synchronize, it could be programmed to a different truck or could have failed. Contact your dealer to re-program your key fob.

Engine Maintenance

Important precautions before performing engine maintenance on your vehicle.

These topics relate to the operator maintenance tasks for the engine. Information provided here is in addition to information contained in the Engine Operator Manual supplied with the vehicle.



WARNING

Exhaust fumes from the engine contain carbon monoxide, a colorless and odorless gas. Do not breathe the engine exhaust gas. A poorly maintained, damaged or corroded exhaust system can allow carbon monoxide to enter the cab. Entry of carbon monoxide into the cab is also possible from other vehicles nearby. Failure to properly maintain your vehicle could cause carbon monoxide to enter the cab, resulting in death or personal injury.



WARNING

Never start or let the engine run in an enclosed, unventilated area. Exhaust fumes from the engine contain carbon monoxide, a colorless and odorless gas. Carbon monoxide can be fatal if inhaled. Failure to comply may result

in death, personal injury, equipment or property damage.



WARNING

Never idle your vehicle for prolonged periods of time if you sense that exhaust fumes are entering the cab. Investigate the cause of the fumes and correct it as soon as possible. If the vehicle must be driven under these conditions, drive only with the windows open. Failure to repair the source of the exhaust fumes may result in death, personal injury, equipment or property damage.

i NOTE

Keep the engine exhaust system and the vehicles cab ventilation system properly maintained. It is recommended that the vehicles exhaust system and cab be inspected (1) By a competent technician every 15,000 miles (24,140 km) (2) Whenever a change is noticed in the sound of the exhaust system (3) Whenever the exhaust system, underbody, or cab is damaged.

al injury, equipment or property damage.

i NOTE

It takes approximately 15 minutes for all the oil to run into the sump when the engine is 'warm.' If the level is checked immediately after switching off the engine, the dipstick will show a low oil level.

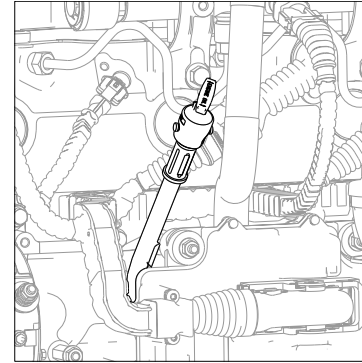

5

Check Engine Oil Level

Refer to the engine manufacturer's Engine Operation and Maintenance Manual supplied with your vehicle for information about draining and refilling engine oil, engine crank case capacity, engine oil type, and changing oil filters, etc.

! WARNING

Hot engine oil can be dangerous. You could be burned. Let the engine oil cool down before changing it. Failure to comply may result in death, person-

1. Make sure that the vehicle frame rail is standing on a flat and level surface.
2. Make sure that the vehicle is horizontal, both lengthwise and crosswise. Check this carefully on a vehicle with air suspension. Note that the engine may be inclined up to 4° depending on the vehicle model and wheelbase.
3. Twist the dipstick handle to unlock it, then pull the dipstick out of the holder.
4. Wipe the dipstick clean with a lint-free cloth.
5. Place the dipstick back into the holder.
6. Pull the dipstick out again and check the oil level. The oil level

should always be between the 2 marks on the dipstick.

Engine Oil Dip Stick Markings

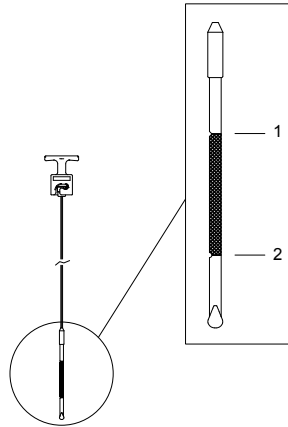

1. High oil level (1)
2. Low oil level (2)
7. Reinstall the dipstick and twist to lock it in place.

Topping Up the Engine Oil

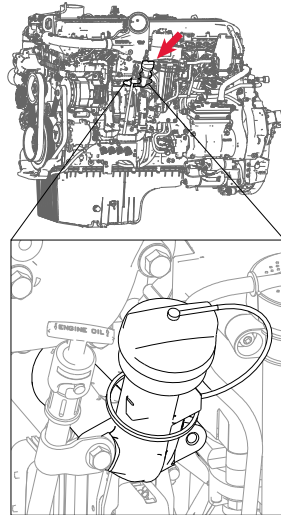

1. Top up with oil, if necessary, via the filler opening. Use the correct grade in the correct quantity. For oil replacement, please see engine Operator's Manual included with this chassis.
2. After topping up, wait 1 minute and check the oil level again.
3. Reinstall the oil fill cap and twist to lock it in place.

Pipe and Hose Clamp Torque Values

Torque specifications for engine parts.

These references are for pipes and hoses in the engine area.

Application	Type of Clamp	in-lb	N•m
Radiator and Heat Exchanger Hoses	Constant Torque CT-L	10.2-12.5	90-110
Heater Hoses	Constant Tension	not required	not required
Air Intake Pipes	Hi Torque HTM-L	11.3-14.2	100-125
Plastic Air Intake Pipes	Constant Torque CT-L	4.5	40 (maximum)
Charge Air Intake Hoses	Flex Seal	7.9-11.3	70-100
	B9296	6-7	50-60
Fuel, Oil and Water Heat Exchangers (for hoses less than 9/16" diameter).	Miniature 3600L	1.1-1.7	10-15

Install Engine Belt

You can extend the reliability and service life of your vehicle's drive belts with proper attention to installation, and maintenance. Neglect could cause belt failure. The result could be the loss of the electrical or air system as well as possible engine damage from overheating. So it's a very good idea

to check your belts frequently and replace them as soon as you detect trouble.



NOTE

See the engine manufacturer's operator's manual for further information on replacing engine drive belts.

Follow this procedure to install an accessory drive belt:

1. Route the new belt around the pulleys, and then rotate the automatic tensioner so that the idler pulley swings toward the belt routing. The following figure shows an example of the rotation direction to release the tensioner.

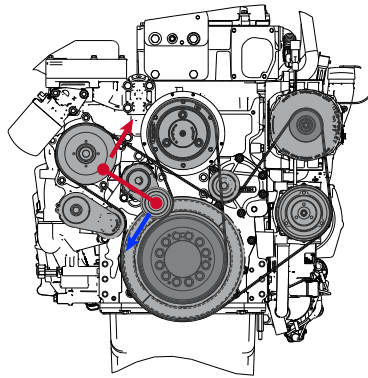

2. Slip the belt around the idler pulley attached to the automatic tensioner.
3. Release the automatic tensioner.
4. Check the belt alignment on each pulley. The belt must fall between the flanges of each pulley.

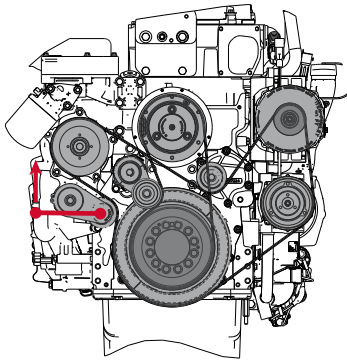

Engine Fan

General maintenance information and precautions about the engine fan.



WARNING

Do not work on or near the fan with the engine running. Anyone near the engine fan when it turns on could be injured. If it is set at **MANUAL**, the fan will turn on any time the ignition key switch is turned to the **ON** position. In **AUTO**, it could engage suddenly without warning. Before turning on the ignition or switching from **AUTO** to **MANUAL**, be sure no workers are near the fan. Failure to comply may result in death or personal injury.

Your truck may be equipped with an On/Off or Viscous Fan Drive. Follow these guidelines to check your engine fan:

- Check the fan bearings for fan hub bearing looseness, loss of lubricant and any abnormal conditions. (For example, fan belt misaligned or excessive wear/damage.) Before starting the engine and with the engine off, look and feel for looseness in the fan hub.
- With the engine idling and the hood open, stand at the front of the vehicle. Listen for any noises coming from the fan hub. Bearings that have lost lubricant, and are dry, will typically emit a squeal or a growl when the engine is at operating temperature and the fan clutch is engaged. If noise is detected, have the fan bearings inspected by an authorized dealership.

Engine Fan Blade

Verify that there is enough fan blade clearance with the fan shroud. Around the fan shroud, the recommended distance is 1 in. (25 mm) from front edge of any fan blade-to-radiator side member. Minimum clearance is 3/4 in. (19 mm).

- Rear edge of any blade must be no closer than 3/8 in. (9 mm) to the nearest engine component. If this cannot be obtained, the fan spacer or fan is not correct.
- The leading edge of any fan blade must be 1 in. (25 mm) from the inside edge of the shroud.

Air Intake System

General information and precautions on how to maintain the air intake system.

Engine heat, vibration, and age combine to loosen air intake connections and cause cracks in the tubing and elbows. Leaks in the intake system allow abrasive dust to enter the engine and quickly cause expensive damage. During your daily walk-around inspection, carefully check all tubing, elbows, clamps, supports and fasteners for condition and tightness. Check the Charge-Air-Cooler for air leaks annually. The air leaks can be caused by cracked tubes or header. For service see your authorized dealer.



CAUTION

DO NOT use air intake pipes and connections as a step or to pull yourself up. This could loosen the connections and open the system to unfiltered air which could damage the engine.

Turbocharger

General information about maintaining the turbocharger.



WARNING

Do not operate engine with turbocharger intake piping disconnected. A suction is created when the engine is running. This suction could draw your hand or anything else near it into the impeller fan. You could be injured. Always keep the intake piping connected when you will be running the engine.

When servicing the air intake and exhaust systems on a turbocharged engine, check the items listed below:

Lubricating System

Check the oil lines, housing, and connections. Look for leaks, damage, or deterioration. Leaks could mean you have damaged oil lines or oil seals.

Manifold

With the engine operating, check for leaking manifold or flange gaskets.

High Frequency Vibration

Vibration may indicate turbo rotor imbalance. Have your dealer investigate this immediately. If you detect any deficiencies, take the vehicle to an authorized dealer for servicing. Delay could lead to severe and expensive damage to your vehicle.

Air Cleaners

General information about servicing air cleaners.

The following service information is basic to all air cleaner makes and models.



WARNING

Do not use air cleaner components as grab handles. These components may break if you are using them to support your weight. Failure to comply may result in personal injury or damage to vehicle components.



WARNING

Do not push on the under hood air door with hands. This door is held closed with a spring which may shut close unexpectedly. Failure to comply may result in personal injury.



CAUTION

Failure to replace air filter at proper intervals may result in passage of dirt/debris into the engine or the “dusting” of an engine resulting in significant equipment damage.

Your vehicle is equipped with an air inlet restriction indicator. Service the filter

elements when the air inlet restriction indicator locks in the extreme Up position. Paper elements require care and proper handling because they are critical to engine service life.

The engine air filter is located on the top of the engine just below the hood. There are (4) fasteners that hold the cover to the filter housing.

If the vehicle has the under hood air intake option, the air intake solenoid and the airline will need to be removed to access the air filter.

Remove and Install Optional Solenoid on Air Cleaner

Maintenance instructions for servicing the engine air cleaner.

These instructions are for removing and installing the under hood air intake solenoid from an air cleaner housing for vehicles with the optional under hood air intake switch on the dash. This solenoid must be removed to access the air filter. With the under hood air intake option, there is an additional step required to disconnect the air line attached to the air cleaner housing to access the air filter.



WARNING

Drain the air tank to depressurize the air system before disconnecting any air hoses. Failure to perform this step may result in personal injury.



CAUTION

Ensure no foreign debris enters in solenoid/airline. Failure to comply may result in equipment damage.

1. Park the vehicle, set the parking brake and turn the ignition OFF.
2. Open hood.
3. Drain front air service tank of all air pressure.
4. Disconnect the air line at the connection on the air filter housing. Push in on the collar and then pull the air hose out.



WARNING

Do not disconnect any lines at the solenoid body. They could be pressurized which may result in personal injury.

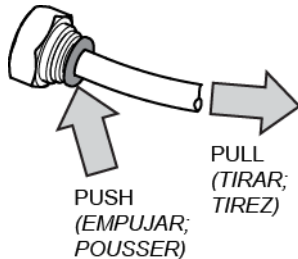
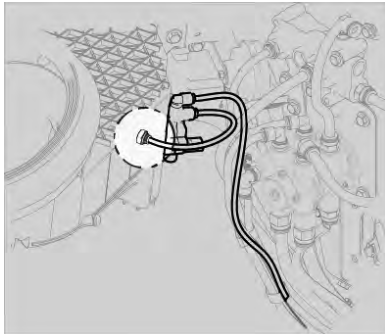

- Remove the single bolt (with a 13 mm wrench) that holds the solenoid to the filter housing.

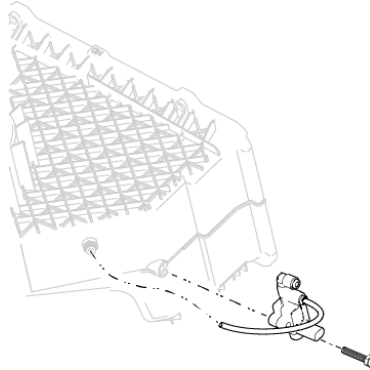

- Cover the air hose end and the fitting with tape or something lint free to keep airline free from debris.
- To reinstall the air solenoid, tighten the 13 mm bolt to 70 ± 5 in- lbs.
- To reinstall the air line to the solenoid, push the air hose into the fitting then pulling on the air hose to ensure that it is properly seated.

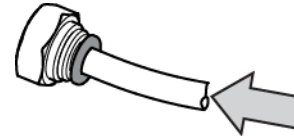

PUSH
(EMPUJAR;
POUSSER)

- Verify that there are no air leaks, start the engine and allow the air system to reach operating pressure. Activate the under hood air switch and verify that there are no air leaks.

Disconnecting the air solenoid will allow the air cleaner housing to be removed to access the air filter.

Replace Engine Air Filter

Maintenance information about servicing the engine air intake filter.

If the vehicle has under hood air intake option, remove the air solenoid first.

Engine Air Intake Filter Module

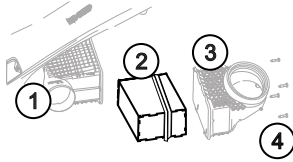

1. Main enclosure
2. Air filter
3. Housing
4. Screws

1. Park the vehicle. Set the parking brake and turn the ignition OFF.
2. If air intake is located under the hood, open hood.
3. Loosen the (4) screws, with a 10 mm wrench, that hold the housing to the main filter enclosure. (These screws will not come out of the housing.)
4. Pull the air filter housing away from the main enclosure to access the filter.
5. The filter can be removed by gently pulling directly out of the main enclosure. Be careful not to

drop or tap the filter on the housing during removal as this could loosen dirt and dust trapped in the filter. DO NOT clean and reuse the original filter.

6. Inspect the sealing surface and clean out any debris from the air filter housing and enclosure before installing a new filter. Be careful to not push any contaminant into the engine inlet.
7. Visually inspect the new filter and the filter housing for damage, especially the sealing surfaces and filter media.
8. Install the filter housing. DO NOT use the housing to drive the filter into position. Tighten screws to 30 lb-in \pm 5 (3.4 N·m \pm 0.56).
9. Start the engine and allow the air system to reach operating pressure. Activate the under hood air switch and verify that there are no air leaks.

Ember Packs (Optional)

Certain vocational models will have an Ember pack on either side of the hood rather than the air pre-cleaner. This ember

pack is installed to keep burning embers from entering the air filter.

Maintenance is required to ensure proper performance of the pack. At each engine intake filter change, remove these packs and clean them with water. Be sure to rinse with water in opposite direction of normal air flow.

How to remove the ember pack:

1. Remove the 7 M6 fasteners using an 8 mm wrench.

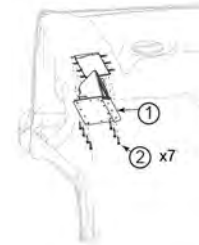

2. Pull the pack away from the hood until the outboard hooks clear the opening.

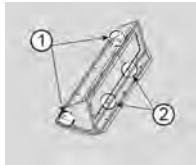

3. Rotate the pack about the hooks and pull further away which will allow the inboard hooks (2) to clear the opening that leads to the air cleaner.

Exhaust System

General information on maintaining the exhaust system.

The exhaust system is part of the noise and emission control system. Periodically check the exhaust system for wear, exhaust leaks, and loose or missing parts. For details on how to maintain the emissions components in the exhaust system, see "Noise and Emission Control" in your vehicle operator's manual. Please refer to the Engine Operator's Manual for more details on how to maintain the emission's components in the exhaust system.

Engine Mounting

Periodic Inspection: Inspect engine mounts every 60,000 miles (96,560 km).

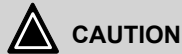

DO NOT re-torque or reuse existing flange head bolts. These bolts are factory set to the specified torque. If bolts are loose or damaged, they must be replaced with the new bolts. Failure to comply may result in equipment or property damage.

Check for the following:

- Inspect both mount and leg fasteners. Check for loose or broken bolts. Replace as necessary.
- Check mount and leg for fractures, breaks or deformation. Replace as necessary.
- Check for complete insertion of motor mount. Replace as necessary.
- New leg to mount flange head bolts should be torqued to 210-230 lb-ft (284-311 Nm).

Fuel System

Important information on your vehicle's fuel system.

Location of Fuel Shut-off Valves

Fuel shut-off valves for the fuel crossover line are on the bottom of the secondary fuel tank, at the crossover line connection. They are optional on the primary fuel tank.

Specification

Use only diesel fuel as recommended by engine manufacturers.



Diesel fuel in the presence of an ignition source could cause an explosion. A mixture of gasoline or alcohol with diesel fuel increases this risk of explosion. Do not remove a fuel tank cap near an open flame. Use only the fuel and/or additives recommended for your engine. Failure to comply may result in death, personal injury, equipment or property damage.



CAUTION

If anyone ever pours gasoline into your fuel tank, drain the entire system. Otherwise, the pump and engine will be damaged. Don't try to dilute the gasoline by adding diesel fuel (See Warning above).

Fuel Filters

See Engine Manufacturer's Operator Manual provided with this chassis.

Frame



WARNING

Do not cut, splice or weld frame rails or drill through the top or bottom flanges of the rails. These operations could affect frame rail strength leading to a failure resulting in an accident. Rail failures resulting from such modifications are not warrantable. Failure to

comply may result in death, personal injury, equipment or property damage.



WARNING

Frame welding is NOT recommended. The high heat of welding nullifies the special heat treatment of the rails, greatly reducing the tensile strength of the frame rail. If a frame member becomes cracked from overloading, fatigue, surface damage or a collision, the only permanent repair is to replace the damaged frame member with a new part.

Emergency Welding

In an emergency, a temporary repair may be performed. Observe the following precautions to protect electronic systems during welding operations. Emergency welding procedures are further explained in the maintenance manuals. Please refer to the ordering information on the back cover to obtain a maintenance manual. In the event of emergency welding of a frame rail and when welding any other part of your truck or any component attached to

your truck, observe the following precautions before welding:

- Disconnect all electronic devices. It is not possible to list all of the electronics that could be affected, but a few examples include the following: alternator, engine Electronic Control Unit (ECU), transmission ECU, ABS ECU, navigation devices, diagnostic devices, and monitoring devices.
- Disconnect battery cables and insulate them from the vehicle.
- Do not use the ECU or engine ground stud for the ground of the welding probe.
- Ensure that the ground connection for the welder is as close to the weld point as possible. This ensures maximum weld current and minimum risk to damage of electrical components on the vehicle.

Painting

Do not electrostatically paint your truck or any component on your truck without first removing all of the electronic components from the truck. It is not possible to list all of the electronics that could be affected, but a

few examples include the alternator, engine Electronic Control Unit (ECU), transmission ECU, ABS ECU, navigation devices, diagnostic devices, and monitoring devices.

Related reference

Fifth Wheel Monthly Maintenance

Proper preventive maintenance is essential to trouble-free service and safe operation of the fifth wheel.

- Refer to specific manufacturer's literature for any special instructions.
- Steam clean the fifth wheel.
- Check lock guard operation using a commercial lock tester.
- Clean and oil all moving parts.
- Lubricate the lock mechanism with a lithium-base grease.
- All grease fittings (especially those which grease the top surface of the fifth wheel).

Fifth Wheel Bi-Annual Maintenance

Proper preventive maintenance is essential to trouble-free service and safe operation of the fifth wheel.



NOTE

Whenever possible, torque all frame fasteners on the nut end, not the bolt head.

- Refer to specific manufacturer's literature for any special instructions.
- Remove fifth wheel from vehicle. Refer to the Shop Manual, "Fifth Wheel Removal."
- Steam clean the fifth wheel and mounting brackets.
- Check all moving parts for excessive wear or damage. Replace all worn or broken parts.
- Complete two-month service procedure.
- Install fifth wheel. Refer to the Shop Manual, "Fifth Wheel Installation."

Tighten all frame fasteners with a torque wrench. See [Frame Fastener Torque Requirements](#) on page 275.

Sliding Fifth Wheels

Lubricate bearing surface of support bracket through the grease fittings on the side of the fifth wheel plate. Use a water resistant lithium-base grease.



NOTE

The plate must be lifted up slightly to relieve the weight of the bracket while applying grease.

Front Axle and Suspension

Lubrication and inspection of front axle assemblies.

Axle Lubrication

Refer to the axle manufacturer's operator's manual for lubrication specifications and service intervals.

Kingpin Lubrication

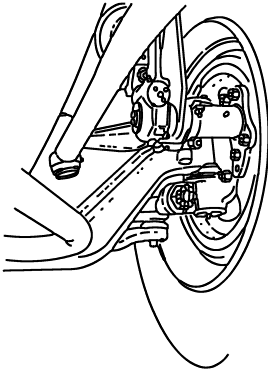

Lubricate with approved lubricant. Lubricate knuckle thrust bearings, knuckle pins, and tie rod ends. Lack of lubrication causes premature wear and hard steering. Lubrication schedule may be shortened if necessary.

Suspension Lubrication

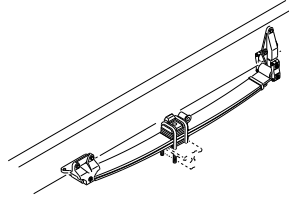

Each standard spring anchor pin has a grease fitting. Pressure lubricate spring pins as specified. At regular intervals, the spring leaves may be lubricated with a rust-inhibiting oil applied with a spray gun or brush. Depending on your suspension, lubricate all spring pins until grease flows out of both ends of the bushing. Look for signs of rust or water in the flushed grease. If a pin will not accept grease, it should be removed, cleaned, and inspected.



CAUTION

DO NOT spray the suspension with chemical products or mineral oil; it can cause damage to the bushings.

Inspection

For all vehicles, mandatory maintenance procedures include retightening all U-bolts and inspecting the suspension for loose fasteners, abnormal wear, or damage. However, even with proper maintenance, the service life of leaf springs is affected by many factors, such as: fatigue, vehicle gross weight, type of load, road conditions, and vehicle speed. Check for cracks, wear marks, splits, or other defects on the surface of the spring. Defective parts must be replaced. Because repaired springs cannot be fully restored to their original service life, replace the complete assembly if cracks or other defects are detected. Visually inspect shock absorbers and rubber bushings.

Wheel Alignment

For driving safety and comfort, and to prolong the life of your vehicle, it is important to have wheels correctly aligned. Check tire wear frequently. Uneven tire wear is a sign that the wheels may be misaligned. If you see uneven wear, take your vehicle to an authorized dealer familiar with aligning wheels on your vehicle.

Suspension U-Bolts

It is important that U-bolts remain tight. Severe use of your vehicle will cause them to loosen faster. But all vehicles need to have their U-bolts checked and tightened regularly. Be sure someone with the proper training and the right tools checks and tightens the U-bolts on your vehicle. New springs can settle in after service, relieving the tension on the U-bolts. Loose U-bolts can cause leaf spring breakage, axle misalignment, hard steering and abnormal tire wear. All vehicles should have suspension U-bolts tightened after the first 500 miles (800 km) of operation. Re-torque the front spring pinch bolts and shackle pinch bolts.



WARNING

Do not operate the vehicle if the suspension U bolts are not properly tightened. Loose U bolts will cause the axle to not be properly secured to the suspension, which could cause loss of vehicle control and an accident. Loose U bolts can also cause uneven tire wear and poor alignment. Failure to

comply may result in death, personal injury, equipment or property damage.

U-bolts are difficult to tighten unless you have the right equipment. If you cannot tighten them correctly yourself, be sure to have them checked and tightened regularly by an authorized mechanic. Tighten U-bolt nuts to the specified torque value with the vehicle loaded to its normal gross weight. See [Suspension U-Bolts, Grade 8](#) on page 276 specifications for torque values applying to U-bolts and nuts, with clean threads lubricated with Chevron zinc lubricant (SAE 20 or 30 oils acceptable but not preferred).



WARNING

Do not replace U bolts and nuts with common U bolts or standard nuts. These parts are critical to vehicle safety. If the wrong U bolts or nuts are used, the axle could loosen or separate from the vehicle and cause a serious accident. Use only U bolts and nuts of SAE Grade 8 specification or better. Failure to comply may result in

death, personal injury, equipment or property damage.

Related reference

Heater and Air Conditioner Maintenance

Important information to know about maintaining the air conditioner.

The combination heater-air conditioner provides comfort for those in the cab through accurate control of the cab environment in all weather conditions. Regular attention to the items below will help you keep the heater-air conditioner unit running well. Keep the vehicle's ventilation system, engine exhaust system and cab joints properly maintained. It is recommended that the vehicle's exhaust system and cab be serviced as follows:

- Inspected by a competent technician every 15,000 miles
- Whenever a change is noticed in the sound of the exhaust system
- Whenever the exhaust system, underbody or cab is damaged

To allow for proper operation of the vehicle ventilation system, proceed as follows:

- Keep the inlet grille at the base of the windshield clear of snow, ice, leaves and other obstructions at all times.
- Keep the exhaust pipe area clear to help reduce the buildup of exhaust gas under the vehicle.
- Check the drain tube of the fresh air inlet for trapped water before assuming that there is a leak in the heating system.

Special Precautions



WARNING

Excessive heat may cause the pressurized components of the air conditioning system to explode. Never weld, solder, steam clean, or use a blow torch near any part of the air conditioning system. Failure to comply may result in death, personal injury, equipment or property damage.



WARNING

Air conditioning refrigerant can be hazardous to your health. Do not expose yourself to leaking refrigerant for prolonged periods near excessive heat, open flames, or without proper ventilation. Failure to do so may result in death or personal injury.

If a refrigerant leak develops in the presence of excessive heat or an open flame, hazardous gases may be generated. If you become aware of a refrigerant leak on your vehicle have your system serviced immediately and observe the following precautions: Stay away from the hot engine until the exhaust manifold has cooled. Do not permit any open flame in the area. Even a match or a cigarette lighter may generate a hazardous quantity of poisonous gas. Do not smoke in the area. Inhaling gaseous refrigerant through a cigarette may cause violent illness.

Heater



CAUTION

During extreme cold weather, DO NOT blow hot defroster air onto cold windshields. This could crack the glass. Turn the Air Flow Control Dial to Defrost and adjust the fan speed accordingly while the engine warms. If the engine is already warm, move the Temperature Control Dial to "cool," then gradually increase the temperature when you see that the windshield is starting to warm up. Failure to comply may result in equipment damage.

- Check all heater controls for full-range operation.
- Check hoses, connections, and heater core for condition and leaks.

Air Conditioner



WARNING

The air conditioning system is under pressure. If not handled properly during servicing, it could explode. Any servicing that requires depressurizing and recharging the air conditioning system must be conducted by a qualified technician with the right facilities to do the job. Failure to comply may result in death, personal injury, equipment or property damage.



WARNING

Wear eye protection any time you blow compressed air. Small particles blown by compressed air could injure your eyes.

- Listen to the compressor and drive clutch for noise and vibration. If you find problems, have the system checked thoroughly. A malfunctioning clutch usually indicates trouble elsewhere in the system.

- Check the evaporator core, filter, and condenser core for debris restricting air flow. Clean if necessary. Small particles may be removed with compressed air blown through the core in the opposite direction of normal air flow.
- Check the engine belt for condition and proper tension.
- Check all hoses for kinks, deterioration, chafing, and leaks. Adjust kinked or chafing hoses to eliminate restrictions and prevent further wear.
- Check all components and connections for refrigerant leaks. If you discover a leak, do not try to tighten a connection. Tightening a connection may cause a leak to worsen. Have a qualified technician correct the problem.



NOTE

A leaking evaporator or condenser core cannot be repaired; it must be replaced.

Have the air conditioning system fully serviced annually by your authorized dealer. Qualified service technicians will have to evacuate and recharge the system.

How to Replace Air Conditioner Filter

The fresh air filter for the cab HVAC is located in the air intake housing that is located in the passenger rear corner of the engine compartment. The filter can be replaced without using any tools.

Inspect and clean cab air filter element every 3 - 6 months of service. Depending on the operating environment, if air flow from the air conditioner and heater is less efficient or windows fog easier, you may need to replace the cab air filter.

1. Tilt the hood open.
2. Locate air intake housing at passenger rear corner of vehicle under the rain tray.
3. Locate filter cover labeled "OPEN" with an arrow pointing rearward in vehicle. Slide filter cover rearward in vehicle until you are able to remove the cover.
4. Remove and inspect filter referring to maintenance interval schedule.

5. Replace filter in housing taking care to align the airflow direction that is indicated on the side of the side of the filter element with the airflow direction that is clearly marked on the air intake housing.
6. Replace the filter cover on the air intake housing and slide the cover forward in vehicle. An audible snap sound can be heard when the cover is correctly in place. If the snap feature is damaged there are two screw features that may be utilized to retain the cover in place.
7. Close and secure hood of vehicle.

Replace the Recirculation Air Filter

Please contact an authorized dealer when the service interval is required to inspect the cabin recirculation air filter.

Sleeper HVAC Air Filter

The sleeper recirculation filter is located under the sleeper bunk on the passenger side of the vehicle. Lift the bottom bunk to access the unit. The filter can be replaced without using any tools.

1. Lift the sleeper bunk to expose the sleeper HVAC module.
2. Find the retention tab at the side of the filter element and move it to release the filter. Moving this tab will allow the filter to be removed in an upward direction.
3. Align the airflow direction that is indicated on the side of the filter element such that it points into the HVAC housing.
4. Insert the filter and make sure the retention tab has re-engaged to secure the filter.
5. Close the bunk.

Noise and Emission Control

Information about the federal law prohibiting tampering with the noise and emissions systems.

There are specific components on the vehicle that are designed to meet certain Environmental Protection Agency (EPA) emissions and noise regulations. To maintain conformance with the regulations,

these components need to be functional and properly maintained.

Noise Emission Warranty

Peterbilt warrants to the first person who purchases this vehicle for purposes other than resale and to each subsequent purchaser that this vehicle as manufactured by Peterbilt, was designed, built and equipped to conform at the time it left Peterbilt's control with all applicable U.S. EPA Noise Control Regulations. This warranty covers this vehicle as designed, built and equipped by Peterbilt, and is not limited to any particular part, component or system of the vehicle. Defects in design, assembly or in any part, component or system of the vehicle as manufactured by Peterbilt, which, at the time it left Peterbilt's control, caused noise emissions to exceed Federal standards, are covered by this warranty for the life of the vehicle.

Tampering with Noise Control System

Federal law prohibits the following acts or the causing thereof:

1. The removal or rendering inoperative by any person other than for purposes of maintenance,

repair, or replacement, of any device or element of design incorporated into any new vehicle for the purpose of noise control prior to its sale or delivery to the ultimate purchaser or while it is in use, or

2. The use of the vehicle after such device or element of design has been removed or rendered inoperative by any person. Among those acts presumed to constitute tampering are the acts listed below:
 - Air Intake System
 - Removing or rendering inoperative the air cleaner/ silencers or intake piping.
 - Engine Cooling System
 - Removing or rendering the fan clutch inoperative.
 - Removing the fan shroud.
 - Engine
 - Removing or rendering engine speed governor inoperative so as to allow engine speed to exceed manufacturer's specifications.
 - Modifying ECU parameters.
 - Exhaust System

- Removing or rendering inoperative exhaust system components.
- Fuel System
 - Removing or rendering engine speed governor inoperative, allowing engine speed to exceed manufacturer's specifications.
 - Removing of air signal attenuator on engines equipped with this device.
 - Removing of diesel exhaust fluid tank and system.
- Inner Fender Shields and Cab Skirts
 - Removing shield or skirts.
 - Cutting away parts of shields, skirts or damaged or loose portions of shields or skirts.
- Noise Insulating Blankets
 - Removing noise insulators from engine block or from around the oil pan.
 - Cutting holes in, or cutting away part of noise insulators.
 - Removing hood-mounted noise insulation.

Inspecting Noise and Emission Components

If, during periodic inspection and maintenance of other systems and components, it is found that parts of the noise control system require attention, we recommend that those parts be inspected at more frequent intervals to assure adequate maintenance and performance.

The following instructions are based on inspection of the noise control system at regular intervals as indicated in the [Noise Control System - Maintenance Log](#) on page 274.

Air Intake System

- Do all checks and maintenance procedures listed in this manual under Engine Air Intake System and Air Cleaner.
- Check the induction tubing, elbow connections, clamps, brackets, and fasteners for deterioration, cracks, and security.
- If you find an air leak anywhere between the air cleaner and the engine, repair that leak immediately.



CAUTION

Air leaks cause excessive noise and may result in serious damage to the engine. If you do not repair them the engine damage will not be covered by your warranty. Repair all air leaks as soon as you find them.

Engine Mounted Noise Insulators

- Check condition. Is the insulator secure? How you do this will depend on the method of attaching the noise insulators on the engine and around the oil pan (bolts, snap fasteners, or straps). Tighten loose fasteners and repair or replace any worn or damaged fasteners.
- Check insulators around fasteners and stress points, especially where they may be affected by engine vibration. Repair any cracked or damaged mounting points. Use suitable reinforcing plates to ensure that the insulators will remain in position.

Exhaust System

- Check for exhaust leaks, which would indicate a leaking manifold

gasket; replace gasket if necessary.

- Check cap screws for tightness, including those at the flanges. Refer to the engine manufacturer's service manual for proper tightening sequence and torque values.

Joints and Clamps

- Check for leaks, and tighten as necessary. Check for deterioration or dents in pipes and clamps which could allow exhaust to escape.
- Replace any serviceable joints, flexible pipes and gaskets at the service intervals.

Selective Catalysts Reduction (SCR)

- Check SCR canister filter, clamps and mounting brackets. Tighten if necessary. Inspect SCR canister for signs of rust or corrosion.

Exhaust Piping

- Check exhaust piping for rust, corrosion, or damage. Replace deteriorated piping before holes appear. If piping is perforated at any point, temporary patching or lagging is acceptable until you can have permanent repairs made. On turbocharged engines, check joints

at flanges and mounting brackets for tightness.

Diesel Particulate Filter (DPF)

- Check diesel particulate filter (DPF), clamps, and mounting brackets. Tighten if necessary. Inspect diesel particulate filter (DPF) for signs of rust or corrosion.
- Check internal baffling. You can do this by listening for rattling sounds while tapping on the diesel particulate filter (DPF) with a rubber mallet or revving the engine up and down through its normal operating range.

Diesel Exhaust Fluid Tank (See Aftertreatment System manual.)

Exhaust Tail Pipe

Engine Fan and Shroud

Hood Insulation Blanket

Inner Fenders Shields and Cab Skirts

Rear Axle and Suspension

Maintenance requirements for rear axle suspension.

Your vehicle's suspension, by design, requires a minimal amount of maintenance.

However, suspensions in over-the-road operations require periodic inspection to ensure trouble-free performance.



WARNING

Do not work on the vehicle without the parking brake set and wheels blocked securely. If the vehicle is not secured to prevent uncontrolled vehicle movement, it could roll and may result in death, personal injury, equipment or property damage.



WARNING

Do not operate the vehicle if the suspension U bolts are not properly tightened. Loose U bolts will cause the axle to not be properly secured to the suspension, which could cause loss of vehicle control and an accident. Loose U bolts can also cause uneven tire wear and poor alignment. Failure to comply may result in death, personal injury, equipment or property damage.



WARNING

Failure to maintain the specified torque values or to replace worn parts can cause component system failure, possibly resulting in an accident. Improperly tightened (loose) suspension U bolts can lead to unsafe vehicle conditions, including: hard steering, axle misalignment, spring breakage or abnormal tire wear. Failure to comply may result in death, personal injury, equipment or property damage.



CAUTION

DO NOT spray the suspension with chemical products or mineral oil; it can cause damage to the bushings.



NOTE

Failure to follow these recommendations could void warranty.

Visual Inspection

For all vehicles, mandatory maintenance procedures include retightening of U-bolts and complete inspection. However, even with proper maintenance, many factors affect the service life of springs and suspension components, such as: fatigue, vehicle gross weight, type of load, road conditions, and vehicle speed. It is important that U-bolts remain tight. Severe use of your vehicle can cause them to loosen faster. But all vehicles need to have their U-bolts checked and tightened regularly. Be sure someone with the proper training and the right tools checks and tightens the U-bolts on your vehicle. After the first 500 miles (800 km) of operation, inspect the suspension periodically, as noted below:

- Visually check for loose or missing fasteners, cracks in hanger, or axle connection brackets.
- Check that springs are centered in hangers and in good condition.
- Check for cracks, wear marks, splits, or other defects on the surface of the spring.
- Replace defective parts. Because repaired springs cannot be fully restored to their original service

life, replace the complete assembly if cracks or other defects are detected.

- After replacement of any part or discovery of loose components, check the torque of all fasteners.
- New springs settle-in after the vehicle's initial service, causing the U-bolts to become loose.

Rear Suspension Fasteners

To maintain the performance of the air suspension, check fastener torque values after the first 2,000 miles (3,218 km) of service and every 60,000 miles (96,000 km) thereafter. Torque recommendations apply to fasteners supplied and installed by vehicle manufacture. The values listed in the at the back of this chapter (Specification Reference Charts), are for cadmium plated or phosphate and oil fasteners only. U-bolts are difficult to tighten unless you have the right equipment. If you cannot tighten them correctly yourself, be sure to have them checked and tightened regularly by an authorized mechanic.

Rear Suspension U-Bolts

	NOTE
To ensure an accurate torque reading, use properly maintained and calibrated torque wrenches. Clean the nut and bolt. No dirt, grit, or rust should be present.	

	WARNING
Do not operate the vehicle if the suspension U bolts are not properly tightened. Loose U bolts will cause the axle to not be properly secured to the suspension, which could cause loss of vehicle control and an accident. Loose U bolts can also cause uneven tire wear and poor alignment. Failure to comply may result in death, personal injury, equipment or property damage.	

	NOTE
Whenever possible, torque all frame fasteners on the nut end, not the bolt head.	

Load the vehicle to its normal gross weight before tightening U-bolts. Loading the vehicle ensures proper adjustment of the U-bolt and spring assembly.

	WARNING
Do not replace U bolts and nuts with common U bolts or standard nuts. These parts are critical to vehicle safety. If the wrong U bolts or nuts are used, the axle could loosen or separate from the vehicle and cause a serious accident. Use only U bolts and nuts of SAE Grade 8 specification or better. Failure to comply may result in death, personal injury, equipment or property damage.	

Related reference

Rear Axle Lubrication

Lubrication requirements for rear axles.

See the axle manufacturer's operator's manual for lubrication specifications and service intervals.

Check oil level with the vehicle parked on level ground and the fluid warm. The level

should be even with the bottom of the filler hole.

Rear Axle Alignment

Continual road shock and load stresses may force the rear axles out of alignment. If you detect rapid tire wear on the rear axles, you may have misaligned axles. If you suspect rapid tire wear, have your rear axle alignment checked and adjusted by an authorized dealer.

Suspension alignment should be checked when any one of the following conditions exist:

- Discovery of loose suspension fasteners. (Loose, defined as any torque below the recommended torque value.)
- Discovery of elongated holes in a suspension component.
- Bushing replacement.
- Excessive or abnormal tire wear.

Steering System

The steering system consists of a power steering pump, gearbox and reservoir.



WARNING

Do not operate the vehicle if the steering system is not working properly. You could lose control of your vehicle if the steering system is not in good working condition, which could result in a serious accident. For driving safety, visually check the steering gear and components. Frequent checks are important for driving safety, especially after traveling over rough roads. Failure to comply may result in death, personal injury, equipment or property damage.



WARNING

If this chassis is equipped with an electronic stability system (ESC) and any part of the steering system (e.g., linkage, steering driveline, column, front end alignment, etc) is repaired, removed, or disassembled in any way, or if the steering angle sensor is replaced, the steering angle sensor must be recalibrated. Any repairs or adjustments to any part of the steering system must be performed by an author-

ized dealer. Failure to comply may result in death, personal injury, equipment or property damage.

Oil (under low pressure) provides the power to operate the steering gear. It also serves to lubricate moving parts and remove heat. A loss of steering efficiency will occur if too much heat builds up in the system.

If the steering feels unbalanced from side-to-side while turning, check for the following possible causes:

- unequal tire pressures
- vehicle overloaded or unevenly distributed load
- wheels out of alignment
- wheel bearings improperly adjusted.

If you cannot correct the problem, check with an authorized dealer.

Your vehicle is equipped with integral power steering. The system includes an engine-driven fluid pump, a fluid reservoir, the steering gear, and connecting hoses. Because of the hydraulic power assist, little effort is required to turn the steering wheel. When no input is applied through the steering wheel, the steering gear will return to the neutral position. If, for any reason,

the power assist system goes out, steering the vehicle is still possible, yet it will require much greater effort.

Visually check the following parts:

- Crosstube: Is it straight?
- Draglink tube clamp: Check for looseness or interference.
- Ball joints and steering U-joints: Check for looseness.
- Steering wheel for excessive free-play. Check the simplest probable causes first: a. unequal tire pressures b. loose cap nuts c. bent crosstube d. lack of lubrication.

If these checks do not reveal the problem, or if you correct them and still have a steering problem, take your truck to an authorized dealer for evaluation.

Power Steering Fluid

Have the power steering fluid and filters changed at an authorized dealer.

 **CAUTION**

When adding fluid, be sure to use fluid of the same type. While many fluids have the same description and intended purpose, they should not be mixed

due to incompatible additives. Mixing incompatible fluids may lead to equipment damage.

 **NOTE**

Before removing reservoir cover, wipe outside of cover so that no dirt can fall into the reservoir.

Check and completely change the fluid level. Use the following procedure:

1. Park the vehicle on level ground and turn the engine off.
 2. Open hood
 3. Open the fill cap to the power steering reservoir. In addition to the reservoir itself, the cap has a dipstick that indicates fluid level when the fluid is hot and when it is cold. Each of the conditions have a MAX and a MIN mark.
- If you check the fluid with the engine and steering system COLD, the fluid level should be at/or above the Minimum indicator level and should generally not exceed the middle

- point between Maximum and Minimum level indicators.
- If you check the fluid with the engine and steering system WARM, the fluid should NOT exceed the Maximum level indicator and should generally not drop below the middle point between the Maximum and Minimum level indicators.

Power Steering Fluid Filter

The power steering system has a filter that needs to be maintained.

 **CAUTION**

Servicing the power steering system without bleeding it of trapped air may cause damage to the power steering pump.

1. Park the vehicle and turn the engine off
2. Open the hood and locate the power steering filter housing
3. Open the housing by taking off the top of the housing
4. Replace the filter

5. Replace the fluid
6. When adding new fluid, bleed the power steering system by turning on the engine and turning the steering wheel full right and then full left. Add fluid when necessary as air bleeds out of the system.

Steering Shaft Bolt Torque Specifications

Fastener torque specifications for steering shaft.

For off-highway vehicles, tighten the U-bolts after the first day or two of operation. Then check weekly. The following are common torque specifications for most steering shafts.

Steering U-joint Pinch Bolt

Fastener Size	Tightening Specification ft-lb (N•m)
7/16 inch	55-60 (74-81)

Pitman Arm Clamp Bolt

Fastener Size	Tightening Specification ft-lb (N•m)
3/4 inch	300-320 (406-433)



WARNING

If this chassis is equipped with an electronic stability control (ESC) and is modified (e.g. adding or removing an axle, converting from a truck to a tractor, converting from a tractor to a truck, changing the body, lengthening of the wheelbase and/or frame, relocating frame components, or modifying pneumatic or electrical ABS/ESC harnesses) the ESC must be disabled by a qualified technician. If you have any questions, contact your authorized dealer. Failure to comply may result in death, personal injury, equipment or property damage.

Driveline

General lubrication information for drivelines.

See the driveshaft manufacturer's operator's manual for lubrication specifications and service intervals.



WARNING

Improper lubrication of U joints can cause them to fail prematurely. The driveshaft could separate from the vehicle and result in an accident. Make sure lubricant is purged at all four ends of each U joint and loosen caps if necessary. Also, regularly inspect U joints for excessive wear or movement, and repair or replace as necessary. Failure to comply may result in death, personal injury, equipment or property damage.

Tires

Information on maintaining your vehicle's tires.

Your tires are a very important part of your vehicle's whole braking system. How fast you can stop depends in large measure on how much friction you get between the road and your tires. In addition, keeping your tires in good condition is essential to the safe, efficient operation of your vehicle. Regular, frequent inspection and the right care will give you the assurance of safe and reliable tire operation. Here are some tips on maintaining your tires.

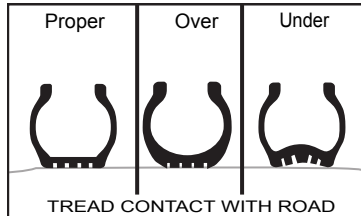

WARNING

Do not repair damaged tires unless you are fully qualified and equipped to do so. Wheel and tire assemblies cannot be worked on without proper tools and equipment, such as: safety cages or restraining devices. Have all tire repairs performed by an expert. Stand away from the tire assembly while the expert is working. Failure to do this may result in death or injury.

Checking Inflation Pressure

Low pressure is a tire's worst enemy. Underinflation allows tires to flex improperly, causing high temperatures to build up. Heat causes early tire damage such as flex break, radial cracks, and ply separation. Low pressure may affect control of your vehicle, especially at the front wheels. Most tire wear problems are caused by underinflation as the result of slow leaks, so you'll want to check tire pressure regularly. Lower tire pressure does not provide better traction on ice or snow. Give your tires a visual test every day, and check inflation with a gauge every week:

- When checking tire pressure, inspect each tire for damage to sidewalls, cuts, cracks, uneven wear, rocks between duals, etc. If a tire appears underinflated, check for damage to the wheel assembly. Don't forget to check between dual wheels. If you find wheel damage, have an expert tire service repair it.
- Maximum tire pressure will be indicated on the sidewall of a tire.
- Check pressure only when the tires are cool. Warm or hot tires cause pressure buildup and will give you an inaccurate reading. So never deflate a warm tire to the specified pressure.



WARNING

Do not operate a vehicle with underinflated tires. The extra heat caused by underinflation can cause sudden tire failure such as a tire fire or blow out, which can cause an accident resulting in death or personal injury. Low pressure may affect control at the front wheels, which could result in an accident involving death or personal injury. Keep your tires inflated to the manufacturer's recommended air pressure.



WARNING

Do not attempt to raise the vehicle to remove or install a damaged tire and wheel assembly if you are not fully qualified and not equipped with the proper tools and equipment. Do not attempt to reinflate a tire that has been run flat. Obtain expert help. A person can be seriously injured or killed if using the wrong service methods. Truck tires and wheels should be serviced only by trained personnel using proper

equipment. Follow OSHA regulations per section 1910.177.



NOTE

Follow all warnings and cautions contained within the tire and wheel manufacturers literature.

Overloaded Tires

Overloading your truck is as damaging to your tires as underinflation. The following chart shows how neglect or deliberate abuse can affect the life of your tires.

Effects of Load and Pressure on Tire Life

Vehicle Load	Tire Pressure	Expected Total Tire Mileage
Normal	Normal	Normal
20% Over	20% Low	70%
40% Over	30% Low	50%

Vehicle Load	Tire Pressure	Expected Total Tire Mileage
60% Over	35% Low	40%
80% Over	45% Low	30%
100% Over	55% Low	25%

Overinflated Tires

Overinflating the tires reduces the tread contact area with the road surface, concentrating all of the vehicle weight on the center of the tread. This causes premature wear of the tire.



WARNING

Overinflated tires can cause accidents. They wear more quickly than properly inflated tires and are more subject to punctures, cracks, and other damage. They could fail and cause you to lose control of your vehicle resulting in an accident causing death or personal injury. Be sure all tires are inflated correctly according to the manufacturer's recommendations.

Matching Tires

Be sure to buy matched tires for your vehicle, especially on the rear axles. Mismatched tires can cause stress between axles and cause the temperature of your axle lubricant to get too hot. Matched tires will help your driveline last longer and will give you better tire mileage.



WARNING

Do not mismatch tires, it can be dangerous. Never mix tires of different design such as steel belted radials and bias ply tires, etc. Mixing tire types and

sizes will adversely affect the road holding ability of both types of tires and can lead to loss of vehicle control and causing death or personal injury.



WARNING

Do not install regrooved or reinforcement repaired tires on steering axles. They could fail unexpectedly and cause you to lose control of your vehicle resulting in an accident causing death or personal injury.

Replacing Tires

Front: Replace front tires when less than 4/32 in. of tread remains. Check at three places equally spaced around the tire.
 Drive Axles or Trailers: Replace tires on drive axles or trailers when less than 2/32 in. of tread depth remains in any major groove. Check at three places equally spaced around the tire.



WARNING

Do not replace original equipment tires with load ratings less than the original

tires. Doing so could lead to unintentional overloading of the tire, which could cause a failure resulting in loss of vehicle control and an accident. Failure to comply may result in death, personal injury, equipment or property damage.



NOTE

To prolong your tires' life and make them safer, have their radial and lateral run-out checked at your dealer. And of course you should have your tires balanced anytime you change a tire.

Tire Chains

If you need tire chains, install them on both sides of each driving axle.



CAUTION

Chains on the tires of only one tandem axle can damage the driveline U-joints and the interaxle differential. Repairs could be costly and time-consuming. Failure to comply may result in equipment damage.

Speed Restricted Tires



WARNING

This vehicle may be equipped with speed restricted tires. Check each tire's sidewall for maximum rated speed. The vehicle should not be operated at sustained speed in excess of maximum rated speed. Failure to comply with these speed restrictions could cause sudden tire failure which can result in death, personal injury or property damage.

Greenhouse Gas Certified Tires

Verify if your vehicle is equipped with Greenhouse Gas certified tires by checking

the Vehicle Emission Control label on the driver's side door frame. If these tires were installed at the factory, Lower Rolling Resistance codes (LRR) identify which tires are certified.



NOTE

The tires installed on this vehicle at the factory as original equipment may be certified for Greenhouse Gas and Fuel Efficiency regulations. Replacement tires must be of equal or lower rolling resistance level (TRRL or Crr). Consult with your tire supplier(s) for appropriate replacement tires.

In order to limit the rolling resistance of the tires and optimize fuel economy, the maintenance procedures specified by the tire manufacture must be followed. Please see Vehicle Emissions Limited Express Warranty for warranty on greenhouse gas certified tires.

Wheels

Information on maintaining your vehicle's wheels.

After the vehicle travels about 50 to 100 miles (80 to 160 km), wheel mountings seat in and will lose some initial torque. Check hub/wheel mountings after this initial period and retighten. Threads should be clean and dry. Do not lubricate wheel nuts or studs.



WARNING

Never use oil or grease on studs or nuts; improper torque readings will result, which could cause improper wheel clamping and could lead to a wheel failure resulting in an accident. Failure to comply may result in death, personal injury, equipment or property damage.

Wheel Replacement with Disc Brake Option



WARNING

Use only the wheel brand, size and part number originally installed. Use of a different wheel brand or size could cause valve stem to interfere with a brake component which could lead to loss of vehicle control. Failure to comply may result in death, personal injury, equipment or property damage.

Vehicles equipped with front disc brakes are fitted with wheels designed specifically for disc brake applications. If it ever becomes necessary to replace an original equipment wheel, the replacement wheel must be the same brand and size as the take-off wheel. On vehicles equipped with 22.5 in. disc wheels, installing the wrong replacement wheel could result in the wheel valve stem making contact with the disc brake assembly. When installing any replacement wheel, always inspect the tires/wheels to ensure there is adequate clearance between other vehicle components. With the hood open, check for clearance between the wheel and disc brake assembly. Use a hydraulic jack to

raise the front of the vehicle off the ground to allow the wheel to spin freely. While rotating the wheel, check to ensure there is adequate clearance between the wheel and disc brake assembly.



WARNING

Improperly mounting and demounting tire and rim assemblies is dangerous. Failure to observe proper precautions could cause the tire rim assembly to burst explosively, causing death or personal injury. See the wheel manufacturer's literature for the proper way to mount and demount your tires and rims. Follow their precautions exactly.



WARNING

Always ensure the hood hold open latch is engaged to keep the hood fully open any time anyone gets under the hood for any reason. Failure to do so may cause the hood to close uncontrollably which may result in death or personal injury.



WARNING

Always support the vehicle with appropriate safety stands if it is necessary to work underneath the vehicle. A jack is not adequate for this purpose. Failure to comply may result in death, personal injury, equipment or property damage.

Disc Wheels



WARNING

Use the correct components and tools when working on wheels. Grooves in the wheel disc or other damage to the disc can weaken the wheel and cause it to eventually come off. This could cause you to lose control of your vehicle, and may result in an accident. Failure to comply may result in death, personal injury, equipment or property damage.

The end of the wheel wrench must be smooth. Burrs on the end of the wrench can tear grooves in the disc. These

grooves may lead to cracks in the disc, and can cause it to fail.

Wheel Bearings

For safe, reliable operation and adequate service life, your wheel bearings must be adjusted properly at the recommended intervals. Contact your authorized dealer to make sure the wheel bearings are properly adjusted.

Tightening Wheel Cap Nuts

Tightening sequence for hub and stud piloted disc wheels.



WARNING

Tighten wheel cap nuts properly. If they are not tightened properly, wheel nuts could eventually cause the wheel to become loose, to fail, and/or to come off while the vehicle is moving, possibly causing loss of control and may result in death, personal injury, equipment or property damage.

Hub Piloted Disc Wheels

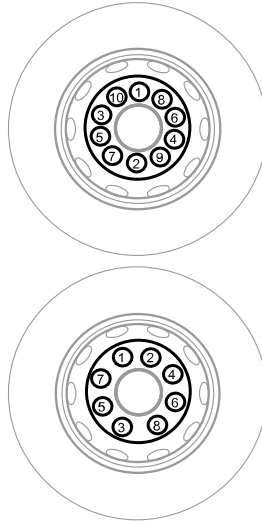

Proper wheel torque can best be obtained on level ground. Install lug nuts and finger-tighten in the numerical sequence as shown below. This procedure will ensure that the wheel is drawn evenly against the hub. Contact an authorized dealer for information on the proper installation procedure for the wheels on your truck.

This is a job you may not be able to do yourself. You need the right torquing equipment to do it.

Stud Piloted Disc Wheels

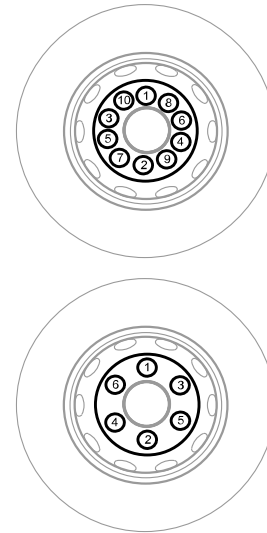

Transmission Maintenance

General maintenance recommendations for maintaining your vehicle's transmission.

See the transmission manufacturer's operator's manual for lubrication specifications and service intervals.



CAUTION

When adding oil, types and brands of oil should not be intermixed because of possible incompatibility, which could decrease the effectiveness of the lubrication or cause component failure.

Vehicles configured with Eaton Automated or a PACCAR transmission must maintain the oil coalescing desiccant cartridge of the air dryer as part of transmission maintenance.



CAUTION

Replace oil-coalescing desiccant air dryer cartridge every 1 year regardless of mileage. Only use oil-coalescing

desiccant replacement cartridge when replacing. Failure to perform this maintenance task will void the PACCAR Transmission warranty and may result in expensive transmission damage.

Hydraulic Clutch

The clutch pedal transmits force from the operator to the clutch via hydraulic and air assist action. The clutch pedal position is factory set and does not require adjustment.

Clutch Hydraulic Fluid

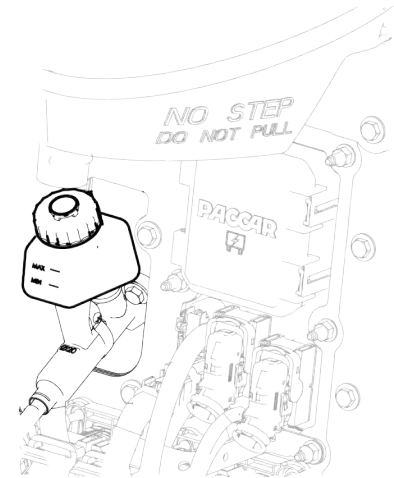

Visually inspect the clutch fluid from the reservoir. There are molded lines with the letters MIN to indicate minimum fluid level and MAX to indicate the maximum fluid level recommended for proper operation. Be sure to maintain the fluid between the MIN and MAX levels indicated on the plastic reservoir. If the fluid level repeatedly goes below the MIN line, then it is time to have your clutch adjusted or the hydraulic system inspected for service. To replace

the fluid, locate the drain fitting on the air solenoid mounted to the transmission housing. Open this fitting and allow fluid to drain out of the system. Once all the fluid is drained out, close the fitting and fill the system through the master cylinder reservoir in the engine compartment. Once the system is full, then purge the system of air by simultaneously pressing on the pedal and opening the fitting to allow air to escape. Close the fitting when fluid starts coming out. Then refill the reservoir. Repeat this until all air has been purged from the system. Replace with the recommended fluid per [Lubrication Specification Chart](#) on page 270.

Clutch Adjustment

Some clutches are self-adjusting, however; there are manually adjusted clutches that will require the operator to know when to adjust the clutch. The clutch will need adjustment when your clutch pedal stroke seems to get longer and its effectiveness at a seamless shift becomes less. Another sign of the clutch needing adjustment is the level of the fluid in the reservoir. If the hydraulic fluid is not leaking, but the fluid level is getting lower, then the clutch may need to be adjusted. Please take the vehicle to an authorized dealership to have the clutch adjusted. See the clutch

manufacturer's Service Manual for the proper adjustment procedures.

Specification Reference Charts

Pipe and Hose Clamp Torque Values

Torque specifications for engine parts.

These references are for pipes and hoses in the engine area.

Application	Type of Clamp	in-lb	N•m
Radiator and Heat Exchanger Hoses	Constant Torque CT-L	10.2-12.5	90-110
Heater Hoses	Constant Tension	not required	not required
Air Intake Pipes	Hi Torque HTM-L	11.3-14.2	100-125
Plastic Air Intake Pipes	Constant Torque CT-L	4.5	40 (maximum)

Application	Type of Clamp	in-lb	N•m
Charge Air Intake Hoses	Flex Seal	7.9-11.3	70-100
	B9296	6-7	50-60
Fuel, Oil and Water Heat Exchangers (for hoses less than 9/16" diameter).	Miniature 3600L	1.1-1.7	10-15

Wheel Cap Nut Torque Specifications

Torque specifications for wheel cap nuts, including standard and metric fasteners.

At the first scheduled lube interval, have all wheel cap nuts torqued to their specified value. After that, check wheel cap nuts at least once a week.

Contact an authorized dealer for information on the proper installation procedure for the wheels on your truck. This is a job you may not be able to do yourself. You need the right torquing equipment to do it.

Wheel and Nut Configuration	Stud Size	Torque for Two Piece Flanged Cap Nuts	
		lb-ft	N•m
Hub-Piloted Disc-Type Wheel w/Two Piece Flanged Cap Nuts: Steel or Aluminum Wheel PHP-10; Budd Uni-Mount-10; WDH-8	M22-1.5	450-500	610-680
Stud Backnuts (when used)	3/4-16	175-200	240-270
	1-14	175-300	240-410

Wheel and Nut Configuration	Stud Size	Torque for Two Piece Flanged Cap Nuts	
		lb-ft	N•m
Cast Spoke Wheel Assembly Rim Clamp Nut Torque	1/2" Dia. 5/8" Dia. 3/4" Dia.	80-90	110-120
	1/2" Dia. 5/8" Dia. 3/4" Dia.	160-185	220-250
	1/2" Dia. 5/8" Dia. 3/4" Dia.	225-245	305-335

*Consult manufacturer or lubricant supplier for special details.

Lubrication Specification Chart



NOTE

The responsibility for meeting these specifications, the quality of the product, and its performance in service rests with the lubricant supplier.

Lubricant Symbol Key

Type	Application
ATF	MD3 or MERCON®-approved automatic transmission fluid
BB	High temperature ball bearing grease. Chevron SRI Mobile Grease HP, Texaco Multifax 2
CB	Engine oil for mild to moderate requirements

Type	Application
CC/CD	Engine oil for severe requirements (MIL-L-2104B /MIL-L-45199B w/ 1.85% max. sulfated ash
CD	Engine oil meeting API "Five engine test sequence"
CD50	SAE50W synthetic transmission fluid
CE	Engine oil meeting severe duty service requirements for direct-injection turbocharged
CJ-4	Engine oil for PACCAR MX and Cummins EGR engines
CL	Multipurpose chassis grease
EP	Extreme Pressure Lubricant (Lithium 12-hydroxystearate base NGLI 2)
GL	Straight mineral gear lubricant
HD	Hypoid Gear Oil, A.P.I. - GL-5, SAE 75W-90FE synthetic gear lubricant
HT	High Temperature grease (Timken Spec. 0-616)
MP	Multipurpose gear lubricant (MIL-L-2105B)
DOT3 or DOT4	Brake Fluid

Component Lubrication Index

Application	Type
Steering Column	CL
Alternator Bearing	BB (1)
Fan Hub	BB (1)
Power Steering Reservoir	ATF
Steering Drag Link	CL
Steering Knuckles	CL
Spring Pins	CL
Clutch Release Bearings	BB
Brake Shoe Anchor Pins	HT
Brake Cam Bearings	HT
Slack Adjusters	CL
Starter Bearings	CC
Turbocharger Aneroid	CC
Water Pump	BB (1)
Suspension Fittings (other than threaded pins and bushings)	EP

Application	Type
Steering Shaft Grease Fittings	EP
Brake Treadle Hinge and Roller	Engine oil
Lock Cylinders	Lock lubricant
Door Hinges	Not required - Teflon bushings
Door Latches and Striker Plates	Polyethylene grease stick
Door Weatherstrip	Silicone lubricant
Hub-piloted Aluminum Wheels	Coat the wheel pilot or hub pads with Freylube #3 lubricant (light colored) or Chevron Zinc lube. Do not get lubricant on the face of the wheel or the hub.
Manual Transmission Hydraulic Clutch	DOT3 or DOT4 (Brake Fluid)
(1) Consult manufacturer or lubricant supplier for special details.	

Steering Gear Lubrication

The following recommendations are for general purpose steering systems (both TRW and Sheppard).

Application	Type
For normal temperatures	Automatic Transmission Fluid (ATF) Type E or F or Dexron® III
For cold temperatures of -22°F (-30°C) and above	ATF Type A

Application	Type
For extremely cold temperatures between -22°F (-30°C) and -40°F (-40°C)	ATF Type B

**Noise Control System -
Maintenance Log**

To ensure your vehicles noise control requirements are maintained, record

maintenance checks. Use the following log sheet and retain copies of documents regarding maintenance services performed and parts replaced on the vehicle.

5

Component	Recommended Interval (Miles)	Date & R.O. No.	Repair Facility & Location	Work Performed	Date & R.O. No.	Repair Facility & Location	Work Performed
Exhaust System Routing Integrity	25,000						
Shutters Shrouds	25,000						
Hood Insulation Blanket	10,000						
Engine Mounted Hose Insulators Fasteners	10,000						
Inner Fender Shields	50,000						
Cab Skirts Fasteners	50,000						

Component	Recommended Interval (Miles)	Date & R.O. No.	Repair Facility & Location	Work Performed	Date & R.O. No.	Repair Facility & Location	Work Performed
Air Intake System Integrity Element	5,000						
Clutch Type Fan Drive	10,000						

Frame Fastener Torque Requirements

Torque specifications for standard and metric frame fasteners, including the fifth wheel.

Use ESNA Style Lock Nut, with nylon insert. Lubricate nylon insert nut lightly with SAE 20/30 oil. Tighten all frame fasteners with a torque wrench. Torque specifications apply to the following fasteners with lightly lubricated threads. These values are applicable to fasteners on the frame and do not apply to u-bolts for the suspension.

Fastener Size	Tightening Specification lb-ft (N•m)
5/16	16-22 (22-30)

Fastener Size	Tightening Specification lb-ft (N•m)
3/8	30-40 (41-54)
7/16	55-65 (75-88)
1/2	80-90 (109-122)
9/16	115-140 (156-190)
5/8	165-195 (224-265)
3/4	290-340 (394-462)
7/8	380-460 (517-626)
1	700-830 (952-1,129)
1-1/8	990-1,170 (1,346-1,591)

Fastener Size	Tightening Specification lb-ft (N•m)
1-1/4	1,380-1,630 (1,877-2,217)

Metric Fastener Size (with nylon insert nuts)	Tightening Specification lb-ft (N•m)
M5	6-9 (8-12)
M6	7-11 (9-15)
M8	17-23 (23-31)
M10	24-32 (33-43)
M12	55-75 (75-101)

Metric Fastener Size (with nylon insert nuts)	Tightening Specification lb-ft (N•m)
M16	120-160 (163-217)
M20	260-340 (352-460)
M20 (All Metal Lock Nuts)	315-350 (427-475)

Related concepts

Suspension U-Bolts, Grade 8

Torque specifications for suspension u-bolts.

Tighten all U-Bolts with a torque wrench. Torque specifications apply to the following fasteners with lightly lubricated threads. Chevron Zinc Lubricant or SAE 20/30 oil should be used on U-Bolt threads. Torque requirements apply to manufacturer proprietary suspensions. All other suspensions must refer and adhere to original manufacturers shop manual.

Standard and Metric Fastener Torque for Grade 8 U-Bolts

U-Bolt Size Diameter (inches)	Torque (N•m)	Torque (lb-ft)
3/4	333-408	245-300
7/8	598-734	440-540
1	925-1,060	680-780
1 1/8	1,470-1,660	1,080-1,220
1 1/4	1,890-2,120	1,390-1,560
1 1/2	3,130-3,860	2,300-2,840
M20	475 +/- 27	350 +/- 20

The values shown here are for suspension u-bolts and should not be applied to bolts and fasteners for the frame.

Related concepts

Rear Suspension Fasteners

Torque requirements for rear suspension fasteners, including standard and metric fasteners.

Torque requirements apply to manufacturer proprietary suspensions. All other suspensions must refer and adhere to original manufacturers shop manual.

SIZE/TYPE	TORQUE	
	N•m	Lb-Ft
M16 nylon-insert nuts	163-217	120-160
M20 nylon-insert nuts	352-460	260-340
M20 all-metal lock nuts	427-475	315-350
1/2 in. nut	109-122	80-90
3/4 in. nut	394-462	290-340
1-1/4 in. nut	1,877-2,217	1,380-1,630

Chapter 6 | INFORMATION

In this Chapter:

Consumer Information.....	279
Vehicle Identification Labels.....	279
Clean Idle.....	282
Greenhouse Gas Certification Label.....	283
Vehicle Emissions Limited Express Warranty.....	283

Consumer Information

How to Order Replacement Parts

Replacement parts may be obtained from an authorized dealership. When you order, it is **IMPORTANT** that you have the following information ready:

- Your name and address.
- Serial number of the truck.
- The name of the part you need.
- The name and number of the component for which the part is required.
- The quantity of parts you need.
- How you want your order shipped.

National Highway Traffic and Safety Administration (NHTSA)

If you believe that your vehicle has a defect, which could cause a crash or could cause death or personal injury, you should immediately inform the National Highway Traffic Safety Administration (NHTSA) in addition to notifying the vehicle manufacturer. If NHTSA receives similar complaints, it may open an investigation, and if it finds that a safety defect exists in a group of vehicles, it may order a recall and

remedy campaign. However, NHTSA cannot get involved in individual problems between you, your dealer, and vehicle manufacturer. Contacting NHTSA is possible through telephone, written mail and email. NHTSA also has a website where you can input your comments directly to them on the web. Please use any of the four ways to contact NHTSA:

Toll Free 888-327-4236 (800-4249153
TTY) 8:00 am to 10:00 pm ET Monday-Friday

Office of Defects Investigations/CRD
NVS-216 1200 New Jersey Ave SE.
Washington, D.C. 20590

www.safercar.gov

email: nhtsa.webmaster@dot.gov

Transport Canada

Canadian customers who wish to report a safety-related defect to Transport Canada, Defect Investigations and Recalls, may telephone the toll free hotline 1-800-333-0510, or contact Transport Canada by mail at:

Transport Canada, ASFAD Place de Ville
Tower C 330 Sparks Street Ottawa ON
K1A 0N5

For additional road safety information, please visit the Road Safety website at: <http://www.tc.gc.ca>

Related information

Vehicle Identification Labels

Information explaining the vehicle identification number location, component, chassis weight, and tire labels.

Each vehicle completed by Peterbilt Motors Company uses a Vehicle Identification Number (VIN) that contains the model year designation of your vehicle. The practice is in compliance with 49 CFR 565, Code of Federal Regulations.

The full, 17-digit VIN is located on the Weight Rating Data Label. The label is located on the driver's side door edge or on the driver's side door frame.

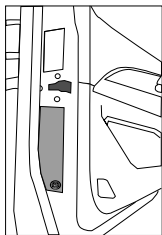
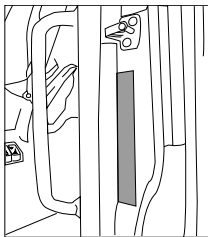

- Cab back, left-hand rear panel, lower edge
- Tire, Rim, and Weight Rating Data label (truck)
- Components and Weights label
- Noise Emission label
- Paint Identification label

Certification Labels

Your vehicle information and specifications are documented on labels. As noted below, each label contains specific information pertaining to vehicle capacities and specifications that you should be aware of.

Components and Chassis Weight Label

The Components and Chassis Weight Label is located on either the driver's side door edge or on the driver's side door frame. It includes chassis number, chassis weight and gross weight, plus model information for the vehicle, engine, transmission, and axles.

Tire, Rim and Weight Rating Data Label

The Tire, Rim and Weight Rating Data Label is located on the driver's side door

edge or on the driver's side door frame. It contains the following information:

- GVWR - Gross Vehicle Weight Rating
- GAWR FRONT, INTERMEDIATE and REAR - Gross Axle Weight Ratings for Front, Intermediate and Rear Axle
- TIRE/RIM SIZES AND INFLATION PRESSURES - Tire/Rim Sizes and Cold Pressure Minimums
- VIN including CHASSIS NUMBER.

The components of your vehicle are designed to provide satisfactory service, if the vehicle is not loaded in excess of either the gross vehicle weight rating (GVWR), or the maximum front and rear gross axle weight ratings (GAWRs).



WARNING

Do not exceed the specified load rating. Overloading can result in loss of vehicle control, either by causing component failures or by affecting vehicle handling. Exceeding load ratings can also shorten the service life of the vehicle. Failure to comply may result in death or personal injury.

Chassis Number

The Chassis Number refers to the last six characters of the VIN. This number will allow your dealer to identify your vehicle. You will be asked for this number when you bring it in for service. Chassis Number Locations

- Right frame rail, top flange, about 3 ft. from the front end

	<p>NOTE</p>
<p>GVW is the TOTAL SCALE WEIGHT the vehicle is designed to carry. This includes the weight of the empty vehicle, loading platform, occupants, fuel, and any load.</p>	

Noise Emission Label

The Noise Emission Label is located in the driver's side door frame. It contains information regarding U.S. noise emission regulations, chassis number, and date of manufacture.

Paint Identification Label

The Paint Identification Label contains the paint colors used by the factory to paint your vehicle. It lists frame, wheels, cab interior and exterior colors. This label is located inside the glove box.

Federal Safety Standard Certification Label

The NHTSA regulations require a label certifying compliance with Federal Safety Standards, for United States and U.S. Territories, be affixed to each motor vehicle and prescribe where such label may be located. This certification label, which

indicates the date of manufacture and other pertinent information, is located on the driver's side door edge or on the driver's side door frame.

Component Identification

Each of the major components on your vehicle has an identification label or tag. For easy reference, record component numbers such as, model, serial, and assembly number.

Engine:	For further information, please refer to the Engine Operation and Maintenance Manual.
Transmission:	For both manual and automatic transmissions, the identification number is stamped on a tag affixed to the right rear side of the transmission case.
Clutch:	Enclosed in clutch housing. Location depends on manufacturer.
Steer Axle:	The front axle serial number is stamped on a plate located on the center of the axle beam.
Axle Specification Number:	Usually stamped on the right rear side of the axle housing. This number identifies the complete axle.
Axle Housing Number:	Usually located on the left forward side of the housing arm. This tag identifies the axle housing.

Axle Differential Carrier Identification:	Usually located on the top side of the differential carrier. The following information is either stamped, or marked with a metal tag: Model No., Production Assembly No., Serial No., Gear Ratio, and Part Number.
---	--

Clean Idle

To comply with CARB emissions requirements your vehicle will either have the Certified Clean Idle label or an Engine Shutdown System (ESS). Some vehicles, however, are exempt from these requirements because of their configurations (for example: fire truck service).

Your vehicle may have either of these labels affixed to the vehicle to identify that its engine meets the strict low exhaust emission regulations instituted by the state of California (and other states that have chosen to adopt CARB emissions requirements). Trucks with this type of engine will not require an Engine Shutdown System and will be allowed to idle continuously. It is important that you do not remove or deface this label. Do not block it from view. Please contact your authorized dealership if you need to replace this label. The dealership will be

able to help you to determine whether or not your vehicle's engine may be a candidate for a Certified Clean Idle label if it did not already have the label. If you have a PACCAR PX-6 or PX-8 engine, your label will look like the image below.



If you have a Cummins engine, your label will look like the image below.



Engine Shutdown System

If the vehicle's engine does not meet the low exhaust emission standard it will have an Engine Shutdown System (ESS) to meet limited idle regulations implemented by CARB and some additional states. These regulations require that the engine have an automatic system to restrict the idle time on certain vehicles. An Engine Shutdown System will shut down the engine after 5 minutes if the vehicle idles with the park brake set and the transmission in 'neutral' or 'park'. The ESS will also allow the vehicle 15 minutes of idle time if the driver does not set the park brake and shifts the transmission to 'neutral' or 'park'. The ESS, however, will not shut down the engine if the engine is operating in Power Take Off (PTO) mode, if the engine coolant is below 60 degrees Fahrenheit, or if the engine is performing a parked regeneration. The check engine light will alert you when the ESS shutdown timer reaches the last 30 seconds before the engine shuts down. The last 30 seconds prior to engine shutdown is the

only time the driver may reset the idle time by pressing on the accelerator. More detailed information may be available in the Engine Operator's Manual provided with your vehicle.

Greenhouse Gas Certification Label

Definition of greenhouse gas label identifiers.

This vehicle may be equipped with components that are identified as Greenhouse Gas Certified components (GHG). A label on the door is printed with codes that identify the components manufactured on the vehicle that are part of the GHG certification. The codes are translated in the following table:

Emission Control Identifier	Emissions Related Components
VSL, VSLS, VSLE, or VSLE	Engine Software parameters that affect the Vehicle Speed Limiter
IRT5, IRTE	Engine software parameters that affect the automatic engine shutdown timer
ATS	Aerodynamic side skirts and/or fuel tank fairings
ARF	Aerodynamic roof fairing
ARFR	Adjustable height aerodynamic roof fairing
TGR	Gap reducing fairing (tractor to trailer)
LRRR, LRRD, or LRRS	Greenhouse Gas (GHG) Tires

Vehicle Emissions Limited Express Warranty

Original Equipment Tires

PACCAR Inc warrants the tires installed as original equipment on this vehicle only against defects in materials and workmanship which cause the vehicle to fail to comply with applicable U.S. and Canadian greenhouse gas emission limits ("Warrantable Emissions Failures"). This vehicle emissions limited express warranty

relating to original equipment tires is valid for two (2) years or 24,000 miles (38,624 km), whichever occurs first. YOUR SOLE AND EXCLUSIVE REMEDY AGAINST PACCAR Inc IS LIMITED TO THE REPAIR OR REPLACEMENT OF ORIGINAL EQUIPMENT TIRES, SUBJECT TO PACCAR'S TIME AND MILEAGE LIMITATIONS LISTED ABOVE. This

Vehicle Emissions Limited Express Warranty relating to original equipment tires begins on the date of delivery of the vehicle to the first purchaser or lessee and accrued time and mileage is calculated when the vehicle is brought in for correction of the Warrantable Emissions Failures relating to the original equipment tires. PACCAR MAKES NO OTHER VEHICLE EMISSIONS WARRANTIES RELATING TO THE ORIGINAL EQUIPMENT TIRES, EXPRESS OR IMPLIED. WHERE PERMITTED BY LAW, PACCAR EXPRESSLY DISCLAIMS ANY WARRANTY OF MERCHANTABILITY OR FITNESS FOR A PARTICULAR PURPOSE RELATING TO VEHICLE EMISSIONS. PACCAR AND THE SELLING DEALER SHALL NOT BE LIABLE FOR INCIDENTAL OR CONSEQUENTIAL DAMAGES INCLUDING, BUT NOT LIMITED TO: LOSS OF INCOME OR LOST PROFITS; VEHICLE DOWNTIME; COMMUNICATION EXPENSES; LODGING AND/OR MEAL EXPENSES; FINES; APPLICABLE TAXES OR BUSINESS COSTS OR LOSSES; ATTORNEY'S FEES; AND ANY LIABILITY YOU MAY HAVE IN RESPECT TO ANY OTHER PERSON OR ENTITY RELATING

TO WARRANTABLE EMISSIONS FAILURES. This Vehicle Emissions Limited Express Warranty relating to original equipment tires is limited to emissions compliance only. The tires are separately warranted by their manufacturer for defects in materials and workmanship other than those which cause non-compliance with U.S. and Canadian GHG regulations, subject to limitations and conditions contained within the tire manufacturer's warranty agreement. You are responsible for the safe operation and maintenance of the vehicle and its tires. PACCAR does not warrant wear and tear of the tires.

Greenhouse Gas (GHG) Components Other Than Tires

This GHG vehicle Warranty applies to the vehicle (hereafter, vehicle) certified with the US Environmental Protection Agency.

Your Warranty Rights and Obligations

This vehicle is warranted for components that directly impact the manufacturers greenhouse gas (GHG) certification with the US Environmental Protection Agency. PACCAR must warrant these components for the periods of time listed below provided there has been no abuse, neglect

or improper maintenance of the vehicle. If a GHG-related part on your vehicle is found to have a defect in material or assembly, the part will be repaired or replaced by PACCAR.

Manufacturer's Warranty Coverage

This warranty coverage is provided for five years or 100,000 miles (160,000) km, whichever first occurs, from the date of delivery of the vehicle to the first purchaser or first lessee. Where a Warrantable Condition exists, PACCAR will diagnose and repair the vehicle, parts and labor included, at no cost to the first purchaser or first lessee and each subsequent purchaser or lessee. This warranty does not override any extended warranty purchased to cover specific vehicle components.

Owner's Warranty Responsibilities

The vehicle owner is responsible for performing required maintenance that is listed in your engine and vehicle Operator's Manuals. The owner is responsible for presenting the vehicle to a service location as soon as a problem exists. Any warranty repairs should be completed in a reasonable amount of time. Retain all receipts covering maintenance

on this equipment. PACCAR cannot deny warranty solely for the lack of receipts or for the failure to ensure the performance of all scheduled maintenance. PACCAR may deny warranty coverage if a vehicle component has failed due to abuse, neglect, improper maintenance, unapproved modifications (both physical components and computer programming) or using non-Original Equipment replacement parts. If there are any questions regarding these warranty rights and responsibilities, please contact the vehicle OEM manufacturer at the customer center telephone number provided with the vehicle operating instructions. Prior to the expiration of the applicable warranty, Owner must give notice of any warranted failure to an authorized PACCAR dealer and deliver the vehicle to such facility for repair. Owner is responsible for incidental costs such as: communication expenses, meals, lodging incurred by Owner or employees of Owner as a result of a Warrantable Condition. Owner is responsible for downtime expenses, cargo damage, fines, all applicable taxes, all business costs, and other losses resulting from a Warrantable Condition. Owner is responsible for maintaining all emissions related engine and vehicle computer

program settings in accordance with manufacturer specifications. This responsibility includes GHG specific settings that may not be altered before the GHG-related expiration mileage has been reached for each system. Owner is responsible for maintaining all physical parts related to GHG-regulations in the as-built configuration and in proper working order for the full regulatory useful life of 435,000 miles (700,000 km) for Class 8 vehicles, 185,000 miles (300,000 km) for Class 6-7, and 110,000 miles (177,000 km) for Class 5.

Replacement Parts

PACCAR recommends that any service parts used for maintenance, repair or replacement of GHG components be new or genuine approved rebuilt parts and assemblies. The use of non-genuine engine or vehicle replacement parts that are not equivalent to the PACCAR engine or OEM vehicle manufacturer's original part specification as built from the factory may impair the engine and vehicle emissions control system from working or functioning effectively, and may jeopardize your GHG warranty coverage. In addition, genuine vehicle or engine parts must be replaced with the same material and

function as the part assembled on the vehicle from the factory. The owner may elect to have maintenance, replacement or repair of the emission control parts performed by a facility other than an authorized PACCAR dealer and may elect to use parts other than new or genuine approved rebuilt parts and assemblies for such maintenance, replacement or repair; however, the cost of such service or parts and subsequent failures resulting from such service or parts may not be fully warranted if the manufacturer determines that the replacement part is not of similar material and function as the OEM part assembled to the vehicle at the factory.

PACCAR Responsibilities

The warranty coverage begins when the vehicle is delivered to the first purchaser or first lessee. Repairs and service will be performed by any authorized PACCAR dealer using new or genuine approved rebuilt parts and assemblies PACCAR will utilize replacement parts that are selected and installed to support the GHG compliance certification. PACCAR will repair parts found by PACCAR to be defective without charge for parts or labor (including diagnosis which results in

determination that there has been a failure of a warranted part).

Warranty Limitations

Sole and exclusive remedy against PACCAR and the Selling Dealer arising from the purchase and use of this vehicle is limited to the repair or replacement of "warrantable failures", for replacement parts that are similar in material and function to OEM specifications and subject to PACCAR's time, mileage, and hour limitations of the greenhouse gas warranty. The maximum time, mileage and hour limitations of the warranty begin with the Date of Delivery to the first purchaser or first lessee. The accrued time, mileage, or hours is calculated when the vehicle is brought in for correction of warrantable failures. PACCAR is not responsible for failures or damage resulting from what PACCAR determines to be abuse, neglect or uncontrollable acts of nature, including, but not limited to: damage due to accident; operation without adequate coolants or lubricants; overfueling; overspeeding; lack of maintenance of cooling, lubricating or intake systems; improper storage, starting, warm-up, run-in or shutdown practices; unauthorized modifications to the vehicle and its components. PACCAR is also not

responsible for failures caused by incorrect oil, fuel or diesel exhaust fluid or by water, dirt or other contaminants in the fuel, oil or diesel exhaust fluid. Failure of replacement parts used in repairs due to the above non-warrantable conditions is not warrantable. This warranty is void if the vehicle is altered with parts that do not meet the material and functional specifications as manufactured from the factory. Any alterations to vehicle or engine computer settings will void GHG warranty and potentially cause the vehicle to become non-compliant with the GHG regulation of the EPA Clean Air Act. Any alterations to GHG specific settings prior to the GHG related expiration mileage for each system will void GHG warranty and potentially cause the vehicle to become non-compliant with the GHG regulation of the EPA Clean Air Act. This warranty is void if certain GHG components are not properly maintained and thus cannot perform to their designed capability. PACCAR is not responsible for failures resulting from improper repair or the use of parts which are not genuine approved parts. PACCAR is not responsible for the material and labor costs of emission control parts and assemblies replaced during Scheduled Maintenance of the engine as specified in

PACCAR Operator's Manuals. THIS WARRANTY, TOGETHER WITH THE EXPRESS COMMERCIAL WARRANTIES ARE THE SOLE WARRANTIES MADE BY PACCAR IN REGARD TO THIS VEHICLE. THIS LIMITED GHG WARRANTY IS THE SOLE WARRANTY MADE BY PACCAR AND THE SELLING DEALER. EXCEPT FOR THE ABOVE LIMITED WARRANTY, PACCAR AND THE SELLING DEALER MAKE NO OTHER WARRANTIES, EXPRESS OR IMPLIED. PACCAR AND THE SELLING DEALER EXPRESSLY DISCLAIM ANY WARRANTY OF MERCHANTABILITY OR WARRANTY OF FITNESS FOR A PARTICULAR PURPOSE. PACCAR AND THE SELLING DEALER SHALL NOT BE LIABLE FOR INCIDENTAL OR CONSEQUENTIAL DAMAGES INCLUDING, BUT NOT LIMITED TO: LOSS OF INCOME OR LOST PROFITS; ENGINE OR VEHICLE DOWNTIME; THIRD PARTY DAMAGE, INCLUDING DAMAGE OR LOSS TO OTHER ENGINES, VEHICLES OR PROPERTY, ATTACHMENTS, TRAILERS AND CARGO; LOSS OR DAMAGE TO PERSONAL CONTENTS; COMMUNICATION EXPENSES; LODGING AND/OR MEAL EXPENSES; FINES; APPLICABLE TAXES OR

BUSINESS COSTS OR LOSSES;
ATTORNEYS' FEES; AND ANY LIABILITY
YOU MAY HAVE IN RESPECT TO ANY
OTHER PERSON OR ENTITY.

Index

Numerics

2.1 Cab [230](#)

A

Active Warnings [68](#)
Adaptive Cruise Control [137](#)
Additives to Cooling System [223](#)
Adjust Seat [24](#)
Aftertreatment System [164](#)
Aiming Headlights [230](#)
Air Cleaners [242](#)
Air Conditioner [112](#)
Air Conditioner Sleeper [118](#)
Air ConditionerDefrost Windshield [117](#)
Air Disc Brakes [215](#)
Air Dryer Maintenance [209](#)
Air Filter Restriction Indicator [140](#)
Air Filter Restriction Symbol [86](#)
Air Intake [24](#)
Air Intake System [242](#)
Air Tank Air Pressure. Trailer [88](#)
Air Tanks [211](#)
Alarm ClockSet alarm [121](#)
Alarm ClockSet time [121](#)
Alert Switch [126](#)
Altering the Electrical System [231](#)
Alternator [236](#)
Anti Theft Menu [74](#)
Auto Slack Adjuster [215](#)
Automatic Slack Adjuster Stroke Specification [216](#)
Axle, Pusher Air Pressure Gauge Symbol [85](#)

Axle, Tag Air Pressure Gauge Symbol [85](#)
Axle, Traction Control [77](#), [78](#), [148](#)
 See *also* ATC
AxleAuxiliary [158](#)
AxleDiff Lock [156](#)
AxleDifferential Lock [156](#)
AxleDual Range [156](#)
AxlePusher Tag [158](#)
AxleTwo Speed [156](#)

B

Batteries [231](#)
BatteryJump start [46](#)
Bendix® AD-IS Series Air Dryer [211](#)
Blank Screen [69](#)
Brake Application Air Pressure, Tractor [87](#)
Brake Application Air Pressure. Trailer [88](#)
Brake System [213](#)
Brake, Park Brake [79](#)
Brake, ParkingManual release [49](#)
Brake, Service Brake [79](#)
Brakes, Anit-Lock Brake System [79](#)
Brakes, Low Air [79](#)
Brakes, Trailer Anti-Lock Brake System [79](#)
Bunk Ladder [15](#), [16](#), [18](#), [19](#), [169](#)

C

Cab Access [13](#)
Cab Maintenance [216](#)
Care of Display Screens on the Dashboard [220](#)
Check Engine Oil Level [238](#)

Clock [68](#)
Column Mounted Transmission Control [107, 144–146](#)
Coolant fill [225](#)
Coolant level [225](#)
Cooling system maintenance [223](#)
Cooling System Overheating [42](#)
Cranking Battery Specification [234](#)
Cruise Control [68](#)
Cruise ControlCancel [136](#)
Cruise ControlChange Set Speed [136](#)
Cruise ControlPredictive Cruise Control [139](#)
Cruise ControlResume Set Speed [136](#)
Cruise ControlSet Speed [136](#)
Cruise ControlStandard [135](#)

D

Daily Checks [36](#)
Dash Switch Tailer Hand Brake [148](#)
Diesel Exhaust Fluid (DEF) [64](#)
Diesel Particulate Filter (DPF) Warning Lamp [80](#)
Differential, Inter Axle Lock [80](#)
Drive Axle Temperature Gauge [87](#)
Driver Information Display [65, 66](#)
 See also Instrument display
Driver Information Display Alarm On/Off [74](#)
 See also Instrument display
Drum Brake Inspection [216](#)
Dump Truck, Body Up [80](#)
Dump Truck, Gate [80](#)
Dump Truck, Trailer Body Up [80](#)

E

Electrical System [228](#)
Ember Packs [245](#)
Emissions [164](#)
Emissions, High Exhaust System Temperature [81](#)
Emissions, Malfunction Indicator Lamp [81](#)

Engine - Coolant Temperature [63](#)
Engine Air filter [244](#)
Engine Brake [103, 106, 107, 134](#)
Engine Brake Allision Automatic Transmission [106](#)
Engine Brake Column Mounted Transmission Control [135](#)
Engine Brake Manual Transmission [106](#)
Engine Brake PACCAR Transmission [135](#)
Engine Cooling Recommendations and Specifications [223](#)
Engine Fan [241](#)
Engine is overheating [42](#)
Engine Maintenance [237](#)
Engine Mounting [246](#)
Engine Wait-To-Start Lamp [82](#)
Engine, Check Engine [81](#)
Engine, Engine Block Heater [82](#)
Engine, Engine Fan [81](#)
Engine, Low Coolant Level [82](#)
Engine, Oil Pressure [64, 86](#)
Engine, Oil Temperature [86](#)
Engine, Overspeed Air Shutdown [82](#)
Engine, Retarder (Brake) [82](#)
Engine, Stop Engine [82](#)
Exhaust [164](#)
Exhaust System [246](#)
Extended Life Coolant [227](#)

F

Fifth Wheel Bi-Annual Maintenance [248](#)
Fifth Wheel Monthly Maintenance [248](#)
Fifth Wheel Slide Switch [96](#)
Frame [247](#)
Frame Fastener Torque Requirements [275](#)
Front axle and Suspension [248](#)
Front Spring Suspension U-Bolts, Grade 8 [276](#)
Fuel Economy [70](#)
Fuel Filter Restriction, Gauge Symbol [85](#)
Fuel Level [63](#)
Fuel Pressure Gauge [86](#)
Fuel System [246](#)

Fuel Water In Fuel (WIF) [83](#)
Fuse box label [230](#)
FuseInspect and replace [44](#)
FuseLocation [46](#)

G

General Safety Instructions [8](#)
Greenhouse Gas Certified Tires [264](#)
Guide to the Warning Symbols [74](#)

H

Hand Brake Trailer [148](#)
Header [69](#)
Heater and Air Conditioner Maintenance [250](#)
High Beam [104](#)
High Beam Flash [105](#)
Horn [108](#)
How to Add Coolant to the Cooling System [226](#)
How to Check for Air System Leaks [212](#)
How to inspect brake pads on disc brakes [215](#)
How to Replace Air Conditioner Filter [252](#)
How to Replace Headlamp Bulb [229](#)
How to Wash the Exterior of the Vehicle [219](#)
Hydraulic Clutch [267](#)

I

Ice [56](#)
Ignition Timer [70](#)
Illustrations [8](#)
In Cab Battery Access [234](#)
inside outside engine air intake [96](#), [130](#)
Inspect Disc Brake Caliper for Running Clearance [215](#)
Inspect Power Steering Fluid [207](#)
Inspecting Noise and Emission Components [254](#)
Install Engine Belt [240](#)

Installing Batteries [234](#)
Instrument cluster [69](#)
Instrument Cluster [61](#)
Instrument displaySet time [74](#)
Instrument displaySet time format [74](#)

L

Lane Departure Warning (LDW) [83](#)
Lights Marker Clearance [105](#)
Lights, High Beam [83](#)
Low Air Alarm [41](#)
Low Oil Pressure Lamp [42](#)
Lubricants [205](#)
Lubrication Specification Chart [270](#)

M

Manifold Pressure Gauge [86](#)
Menu Control Switch [65](#)
Menu Control Switch Cue [69](#)
Mirror Control [109](#)
Mud [56](#)

N

Noise and Emission Control [253](#)
Noise Control System - Maintenance Log [274](#)

O

Odometer/Trip Odometer [67](#)
Oil Level [206](#)
Outside Air Temperature [68](#)

P

PACCAR AMT [146](#)
PACCAR AMT Shifting gears [145](#)
PACCAR Shifter [103](#)
PACCAR Transmission Controls [107](#)
Pipe and Hose Clamp Torque Values [239](#), [268](#)
power distribution box [230](#)
Power Steering Fluid [259](#)
Power Steering Fluid Filter [259](#)
Power Take Off [133](#)
Power Take-off (PTO) [83](#)
Power Take-off (PTO) Pump Mode [83](#)
PTO [133](#)

R

Rear Axle Alignment [258](#)
Rear Axle and Suspension [255](#)
Rear Axle Lubrication [257](#)
Recovery Hitch [51](#)
Recovery hitch capacities [54](#)
Recovery hitch How to use tow pin [52](#)
Recovery hitch Best practices [55](#)
Recovery hitch Manually lock a differential [54](#)
Recovery hitch Prepare axles [53](#)
Refrigerator [84](#)
Remote Keyless Entry [236](#)
Remote Keyless Entry Key fob Battery [236](#)
Remove Optional Solenoid on Air Cleaner [243](#)
Removing Batteries [234](#)
Replace Battery Box Cover [235](#)
Replace the Recirculation Air Filter [253](#)
Returning to Service after Recovering [55](#)
Roadside Assistance [41](#)

S

Safety [6](#)
Safety Alerts [7](#)
Safety Restraint System - Inspection [221](#)
Sand [56](#)
Seat [24](#)
Seat Belt Fasten [84](#)
Settings [73](#)
Sleeper control panel [126](#)
Sleeper HVAC Air Filter [253](#)
Sliding Fifth Wheels [248](#)
Slow Battery Charging [235](#)
Snow [56](#)
Speedometer [62](#)
Stability Control [77](#), [78](#)
Steering Gear Lubrication [273](#)
Steering Shaft Bolt Torque Specifications [260](#)
Steering System [258](#)
Stop Engine Lamp [41](#)
Suspension Dump [84](#)
Suspension Load Air Pressure [87](#)
Synchronize keyfob [237](#)

T

Tachometer [62](#), [63](#), [167](#)
Trailer Hand Brake [94](#)
Tilt Telescope [103](#)
Tire Inflation [84](#)
Tire Pressure Monitoring System [69](#)
Tires [261](#)
Topping Up the Engine Oil [239](#)
Tow Pin [51](#)
Towing the Vehicle [56](#)
Traction Control [100](#)
Trailer Hand Brake [94](#), [148](#)
Trailer Hand Brake Dash Switch [148](#)
Transfer Case Oil Temperature [88](#)

Transmission Oil Temperature, Auxiliary [88](#)
Transmission Retarder Oil Temperature [88](#)
Transmission Temperature Gauge [87](#)
Transmission, Auxiliary [84](#)
Transmission, Check [84](#)
Transmission, Oil Temperature High [84](#)
Transmission, Retarder [84](#)
Transmission, Service Transmission (Allison only) [85](#)
Transmission Maintenance [267](#)
Trip Information [70](#)
Truck Information [71](#)
Turbocharger [242](#)
Turn Signal [103](#), [104](#)
Turn Signal, Left [85](#)
Turn Signal, Right [85](#)

U

Under Cab Battery Access [233](#)
Under hood air cleaner [24](#), [244](#)
Under Hood Air Cleaner [242](#)
Under hood air intake symbol [96](#), [130](#)

V

Vehicle Air Pressure [64](#)
Vehicle ID Labels [279](#)
Vehicle is stuck [56](#)
Vehicle Light Bulb specifications [230](#)
Vehicle Loading [35](#)
Vehicle recovery [48](#)
Vehicle stuck [48](#)
Virtual Gauges [70](#)
Visual inspection while approaching the vehicle [36](#)

W

Warnings and Faults [72](#)

Weekly Checks [38](#)
What is an Air Compressor [213](#)
What is Low Voltage Disconnect [228](#)
What is the Air System [207](#)
What to do before starting the vehicle [33](#)
Wheel Cap Nut Torque Specifications [269](#)
Wheels [264](#)
Window control [109](#)
Windshield Washer [106](#)
Windshield Wiper [105](#)
Windshield Wiper/Washer [228](#)

