

MODEL

535

MODEL

536

MODEL

537

MODEL

548





<b>Safety</b>	<b>1</b>
<b>Emergency</b>	<b>2</b>
<b>Controls</b>	<b>3</b>
<b>Driving</b>	<b>4</b>
<b>Maintenance</b>	<b>5</b>
<b>Information</b>	<b>6</b>

## © 2021 PACCAR Inc. - All Rights Reserved

This manual illustrates and describes the operation of features or equipment which may be either standard or optional on this vehicle. This manual may also include a description of features and equipment which are no longer available or were not ordered on this vehicle. Please disregard any illustrations or descriptions relating to features or equipment which are not on this vehicle. PACCAR reserves the right to discontinue, change specifications, or change the design of its vehicles at any time without notice and without incurring any obligation. The information contained in this manual is proprietary to PACCAR. Reproduction, in whole or in part, by any means is strictly prohibited without prior written authorization from PACCAR Inc.



# Chapter 1 | SAFETY

Using this Manual.....	6
Safety Alerts.....	6
Illustrations.....	7
General Safety Instructions.....	8
Data Recorder.....	11
Environmental Protection Agency.....	11
Repairs.....	11
Additional Sources of Information.....	12
Cab Access.....	12
Deckplate Access.....	14
How to Open the Hood.....	15
Close the Hood.....	16
Seat.....	17
Vehicle Loading.....	22
Visual inspection while approaching the vehicle.....	23

Daily Checks.....	24
Weekly Checks.....	25
Systems Check.....	26

## Using this Manual

Please take the time to get acquainted with your vehicle by reading this Operator's Manual. We recommend that you read and understand this manual from beginning to end before you operate this equipment. This manual contains useful information for the safe and efficient operation of this equipment. It also provides service information, with an outline for performing safety checks and basic preventive maintenance inspections. We have tried to present the information you'll need to learn about functions, controls, and operation—and to present it as clearly as possible. We hope you'll find this manual easy to use.



### NOTE

After you've read this manual, it should be stored in the cab for convenient reference and remain with this truck when sold.

Your vehicle may not have all the features or options mentioned in this manual. Therefore, you should pay careful attention to the instructions that pertain to just your vehicle. In addition, if your vehicle is equipped with special equipment or options not discussed in this manual, consult your dealer or the manufacturer of the equipment.

There are several tools built into this manual to help you find what you need quickly and easily; first is the Quick Table of Contents. Located at the front of the manual, this table lists the main subjects covered and gives section numbers where you can find these subjects. Use the Quick Table of Contents to find information on a large subject and then use the detailed table of contents found on the first page of each chapter. Cross-referenced citations also help you get the information you need. If some other part of the manual contains further information on the subject you are reading about, we'll indicate that in a cross-reference like this: (See Safety Alerts on page 6).

Finally, you'll find a helpful Subject Index. It's in the back of the manual and alphabetically lists the subjects covered. All information contained in this manual is based on the latest production information available at the time of publication. Peterbilt Motors Company reserves the right to make changes at any time without notice.

## Safety Alerts

Read and follow all of the safety alerts contained in this manual. They are there for your protection and information. These alerts can help you avoid injury to yourself, your passengers, and help prevent costly damage to the vehicle. Safety alerts are highlighted by safety alert symbols and signal words such as "WARNING," "CAUTION," or "NOTE." DO NOT ignore any of these alerts.



## Warnings



The safety message following this symbol and signal word provides a warning against operating procedures which could cause death or injury. They could also cause equipment or property damage. The alert will identify the hazard, how to avoid it, and the probable consequence of not avoiding the hazard.

Example:

 <b>WARNING</b>
Hot engine oil can be dangerous. You could be burned. Let the engine oil cool down before changing it. Failure to comply may result in death, personal injury, equipment or property damage.

## Cautions



The safety message following this symbol and signal word provides a caution against operating procedures which could cause equipment or property damage. The alert will identify the hazard, how to avoid it, and the probable consequence of not avoiding the hazard.

Example:

 <b>CAUTION</b>
Continuing to operate your vehicle with insufficient oil pressure will cause serious engine damage. Failure to comply may result in equipment or property damage.

## Notes



The message following this symbol and signal word provides important information that is not safety related but should be followed. The alert will highlight things that may not be obvious and is useful to your efficient operation of the vehicle.

Example:

 <b>NOTE</b>
Pumping the accelerator will not assist in starting the engine.

## Illustrations

Some of the illustrations throughout this manual are generic and will not look exactly like the engine or parts used in your application. The illustrations can contain symbols to indicate an action required and/or an acceptable or unacceptable condition.

The illustrations are intended to show repair or replacement procedures. The procedure will be the same for all applications, although the illustrations may differ.

## General Safety Instructions



### WARNING

Improper practices, carelessness, or ignoring any warnings may cause property damage, personal injury, or death.



### WARNING

Manually rotating the crankshaft requires a trained technician and specialty tools. **DO NOT** pull or pry on the fan in an attempt to rotate the crankshaft. Applying force to the fan can damage the fan blades or cause premature fan failure. Failure to comply with the approved procedure may result in property damage, personal injury, or death.

Before performing any repair, read and understand all of the safety precautions and warnings. The following is a list of general safety precautions that must be followed to provide personal safety. Failure

to follow these instructions may cause death or injury. Special safety precautions are included in the procedures when they apply.

Keep in mind that even a well maintained vehicle must be operated within the range of its mechanical capabilities and the limits of its load ratings. See the Weight Ratings label on the driver's door edge.

Every new vehicle is designed to conform to all Federal Motor Vehicle Safety Standards applicable at the time of manufacture. Even with these safety features, continued safe and reliable operation depends greatly upon regular vehicle maintenance. Follow the maintenance recommendations found in the Preventive Maintenance section. This will help preserve your investment. Make sure your vehicle is in top working condition before heading out on the road, it is the responsible driver's duty to do so. Inspect the vehicle according to the Driver's Check List.

- Work areas should be dry, well lit, well ventilated, free from clutter, loose tools, parts, ignition sources and hazardous substances.
- Wear protective glasses and protective shoes when working.

- **DO NOT** wear loose-fitting or torn clothing. Tie back and/or tuck in long hair. Remove all jewelry when working.
- Before beginning any repair, disconnect the battery (negative [-] cable) and discharge any capacitors.
- Put a "DO NOT OPERATE" tag in the operator's compartment or on the controls.
- Allow the engine to cool before slowly loosening the coolant fill cap to relieve the pressure from the cooling system.

 **WARNING**

Removing the fill cap on a hot engine can cause scalding coolant to spray out and burn you badly. If the engine has been in operation within the previous 30 minutes, be very careful in removing the fill cap. Protect face, hands, and arms against escaping fluid and steam by covering the cap with a large, thick rag. DO NOT try to remove it until the surge tank cools down or if you see any steam or coolant escaping. Always remove the cap very slowly and carefully. Be ready to back off if any steam or coolant begins to escape. Failure to comply may result in death, personal injury, equipment or property damage.

- Always use wheel chocks or proper jack stands to support the vehicle or vehicle components before performing any service work. DO NOT work on anything that is supported only by lifting jacks or a hoist. Before resting a vehicle on jack stands, be sure the stands are rated for the load you will be placing on them.
- Before removing or disconnecting any lines, fittings, or related items, relieve all pressure in the air, oil, fuel, and cooling systems. Remain alert for possible pressure when disconnecting any device from a system that contains pressure. High pressure oil or fuel can cause death or personal injury.
- Always wear protective clothing when working on any refrigerant lines and make sure that the workplace is well ventilated. Inhalation of fumes can cause death or personal injury. To protect the environment, liquid refrigerant systems must be properly emptied and filled using equipment that prevents the release of refrigerant gas. Federal law requires capturing and recycling refrigerant.
- When moving or lifting any heavy equipment or parts, make sure to use proper techniques and assistance. Ensure all lifting devices such as chains, hooks, or slings are in good condition and are of the correct load capacity. Make sure all lifting devices are positioned correctly.
- Corrosion inhibitors and lubricating oils may contain alkali. DO NOT get the substance in eyes and avoid prolonged or repeated contact with skin. DO NOT swallow. If ingested, seek immediate medical attention. DO NOT induce vomiting. In case of contact, immediately wash skin with soap and water. In case of harmful contact, immediately contact a physician. Always keep any chemicals OUT OF REACH OF CHILDREN.
- Naphtha and Methyl Ethyl Ketone (MEK) are flammable materials and must be used with caution. Follow the manufacturer's instructions to ensure safety when using these materials. Always keep any chemicals OUT OF REACH OF CHILDREN.
- When working on the vehicle, be alert for hot parts on systems that have just been turned off, exhaust gas flow, and hot fluids in lines, tubes, and compartments. Contact with any hot surface may cause burns.
- Always use tools that are in good condition. Make sure you have the

proper understanding of how to use the tools before performing any service work. Use only genuine replacement parts from PACCAR.

- Always use the same fastener part number (or equivalent) when replacing items. DO NOT use a fastener of lesser quality if replacements are necessary. (e.g., DO NOT replace a SAE 10.9 grade with 8.8 grade fastener.)
- Always torque fasteners and fuel connections to the required specifications. Overtightening or under-tightening can allow leakage.
- Close the manual fuel valves prior to performing maintenance and repairs, and when storing the vehicle inside.
- DO NOT perform any repair when impaired, tired, fatigued, or after consuming alcohol or drugs that can impair your functioning.
- Some state and federal agencies in the United States of America have determined that used engine oil can be carcinogenic and can cause reproductive toxicity. Avoid inhalation of vapors, ingestion, and

prolonged contact with used engine oil.

- DO NOT connect the jump starting or battery charging cables to any ignition or governor control wiring. This can cause electrical damage to the ignition or governor.
- Coolant is toxic. If not reused, dispose of coolant in accordance with local environmental regulations.



#### CAUTION

Corrosive chemicals can damage the engine. DO NOT use corrosive chemicals on the engine. Failure to comply may result in equipment or property damage.

#### California Proposition 65 Warning

- Diesel engine exhaust and some of its constituents are known to the State of California to cause cancer, birth defects, and other reproductive harm.
- The catalyst substrate located in the Diesel Particulate Filter (DPF) contains vanadium pentoxide,

which has been determined by the State of California to cause cancer. Always wear protective clothing and eye protection when handling the catalyst assembly. Dispose of the catalyst in accordance with local regulations. If catalyst material gets into the eyes, immediately flood eyes with water for a minimum of 15 minutes. Avoid prolonged contact with skin. In case of contact, immediately wash skin with soap and water. In case of harmful contact, immediately contact a physician.

- Other chemicals in this vehicle are also known to the State of California to cause cancer, birth defects or other reproductive harm.
- Battery posts, terminals, and related accessories contain lead and lead compounds, chemicals known to the State of California to cause cancer and reproductive harm. Wash hands after handling.

## Data Recorder

California Vehicle Code - Section 9951 - Disclosure of Recording Device  
 Your vehicle may be equipped with one or more recording devices commonly referred to as "event data recorders" (EDR) or "sensing and diagnostic modules" (SDM). If you are involved in an accident, the device(s) may have the ability to record vehicle data that occurred just prior to and/or during the accident. For additional information on your rights associated with the use of this data, contact:

- The California Department of Motor Vehicles - Licensing Operations Division
- <http://www.dmv.ca.gov>

## Environmental Protection Agency

Some of the ingredients in engine oil, hydraulic oil, transmission and axle oil, engine coolant, diesel fuel, air conditioning refrigerant (R12, R134a, and PAG oil), batteries, etc., may contaminate the

environment if spilled or not disposed of properly.

 **WARNING**

Diesel engine exhaust and some of its constituents are known to the State of California to cause cancer, birth defects, and other reproductive harm. Other chemicals in this vehicle are also known to the State of California to cause cancer, birth defects or other reproductive harm. This warning requirement is mandated by California law (Proposition 65) and does not result from any change in the manner in which vehicles are manufactured.

Contact your local government agency for information concerning proper disposal.

## Repairs

 **WARNING**

DO NOT attempt repair work without sufficient training, service manuals, and the proper tools. You could be kil-

led or injured, or you could make your vehicle unsafe. Perform only those tasks you are fully qualified to do.

 **WARNING**

Modifying your vehicle can make it unsafe. Some modifications can affect your vehicle's electrical system, stability, or other important functions. Before modifying your vehicle, check with your dealer to make sure it can be done safely. Improper modifications can cause death or personal injury.

 **CAUTION**

The installation of electronic devices to the On Board Diagnostics (OBD) connector, the vehicle Controller Area Network (CAN), or their associated wiring is not permitted. Doing so can adversely affect vehicle performance and/or cause fault codes to be recorded. The OBD connector is provided for temporary connection of service tools and for diagnostic purposes only.

Your dealer's service center is the best place to have your vehicle repaired. You can find dealers all over the country with the equipment and trained personnel to get you back on the road quickly—and keep you there.

Your vehicle is a complex machine. Anyone attempting repairs on it needs good mechanical training and the proper tools. However, all warranty repairs must be performed by an authorized service facility. If you aren't an experienced mechanic, or don't have the right equipment, please leave all repairs to an authorized service facility. They are the ones best equipped to do the job safely and correctly.

### Maintenance Manuals

If you do decide to do any complex repair work, you'll need the maintenance manuals. Order them from your authorized dealer. Please provide your Chassis Serial Number when you order, to be sure you get the correct manuals for your vehicle. Allow about four weeks for delivery. There will be a charge for these manuals.

### Final Chassis Bill of Material

A complete, non-illustrated computer printout listing of the parts used to custom-build your vehicle is available through the dealer from whom you purchased your vehicle.

## Additional Sources of Information

Major component suppliers also supply operation manuals specific to their products. Additional manuals and other pieces of literature are included in the glove box literature package. Look for information on products such as the engine, driver's seat, transmission, axles, wheels, tires, ABS/ESC, radio, fifth wheel, lane departure, and adaptive cruise control. If you are missing these pieces of literature, ask your dealer for copies. Another place to learn more about trucking is from local truck driving schools. Contact one near you to learn about courses they offer. Federal and state agencies such as the department of licensing also have information. The Interstate Commerce Commission can give you information

about regulations governing transportation across state lines.

## Cab Access

The following cab and frame entry/exit procedure recommendations were prepared with personal safety foremost in mind.



### WARNING

Do not jump out of the cab or get into the cab without proper caution. You could slip or fall, possibly suffering a injury or death. You could slip and fall if the steps are wet or icy, or if you step in fuel, oil, or grease.

### To help avoid personal injury due to a slip or fall

- Always face the vehicle when accessing or leaving the cab or frame access area.
- Use three points of contact (two feet one hand or one foot two hands) to grip the steps or

handholds whenever possible and look where you are going.

- Use even more care when steps and handholds (or footwear) are wet, coated with ice, snow, mud, oil, fuel, or grease.



### WARNING

Do not step on vehicle components without anti-skid surfaces or use components not designed for entry-and-exit use. You could fall and injure or kill yourself if you step onto a slippery surface.

- Do not step onto the surface of a fuel tank. A fuel tank is not a step. The tank surface can get very slippery, and you might not be able to prevent a fall. Use only the steps and handholds provided, and not the chain hooks, quarter fenders, or other components not designed for that purpose.
- Do not climb onto and off the deck plate; use the steps and grab handle provided. If there is no deck plate, or if proper steps and grab

handles are not provided, do not climb onto the area behind the cab.

- Keep the steps clean. Clean any fuel, oil, or grease off the steps before entering the cab.



### WARNING

Always reinstall the battery compartment cover (step) before entering the cab. Without the battery cover in place, you could slip and fall, resulting in possible injury to yourself.



### NOTE

Any alteration (adding bulkheads, headache racks, tool boxes, etc.) behind the cab that affects the utilization of installed grab handles, deck plates, or frame access steps should comply with Federal Motor Carrier Safety Regulation 399.



### How to Lock and Unlock the Cab Doors

The vehicle has one key for both the cab doors and the ignition. Frame-mounted tool box locks and locking fuel tank caps each have separate, individual keys.

**WARNING**

To help lessen the chance and/or severity of death or personal injury in case of an accident, always lock the doors while driving. Along with using the lap shoulder belts properly, locking the doors helps prevent doors from inadvertently opening and occupants from being ejected from the vehicle.

To lock or unlock the doors from outside the cab:

- Rotate the key toward the rear of the vehicle to lock (clockwise), or
  - Rotate the key toward the front of the vehicle (counter clockwise) to unlock.

**Remote Keyless Entry (Option)**

Remote Keyless Entry (RKE) is a system that adds security and convenience to your vehicle. The system will lock or unlock cab doors with the key fob. The system will alert you with parking lights when the selected doors are locked or unlocked. The system includes two key fobs that provide

secure rolling code technology that prevents someone from recording the entry signal.

**NOTE**

FCC ID: L2C0031T IC: 3432A-0031T  
 FCC ID: L2C0032R IC: 3432A-0032R  
 This device complies with Part 15 of the FCC Rules and with RSS-210 of Industry Canada. Operation is subject to the following two conditions (1) This device may not cause harmful interference, and (2) This device must accept any interference received, including interference that may cause undesired operation. Changes or modifications not expressly approved by the party responsible for compliance could void the user's authority to operate the equipment. The term IC: before the radio certification number only signifies that Industry Canada technical specifications were met.

**Operate Door Locks using Remote Keyless Entry**

Open doors will not lock using the key fob. The key fob should be within 30 feet (9

meters) of the vehicle and should not be in proximity of other RF sources such as television, radio or cell phone transmitters. To unlock the cab doors:

- Press the **UNLOCK** button once. The driver's door will unlock and the parking lights will come on for 40 seconds.
- Quickly press the **UNLOCK** button a second time within 5 seconds to unlock the passenger door.
- Press the **LOCK** button. The doors will lock and the parking lights will come on for 2 seconds.

**Deckplate Access****WARNING**

Always reinstall steps before entering the cab or accessing the deck plate. Without steps you could slip and fall. Failure to comply may result in personal injury or death.



**WARNING**

Keep steps clean. Clean any fuel, oil, or grease off the steps before entering the cab or accessing the deck plate. Stepping on a slippery surface can cause a fall which may result in death or personal injury.

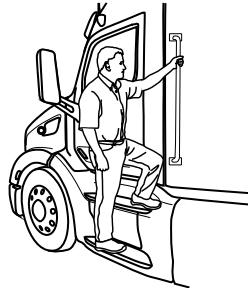
**WARNING**

When you are climbing onto and off the deck plate, maintain at least three points of contact with your hands on the grab handles and your feet on the steps. Always face toward the vehicle when entering or exiting the cab and look where you are going. Failure to comply may result in death or personal injury.

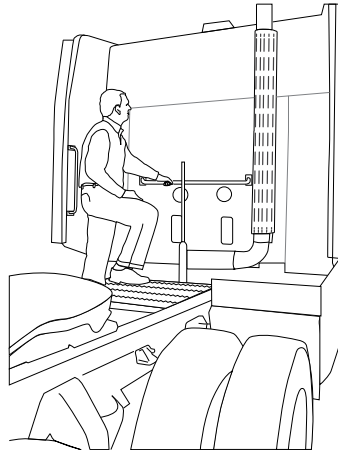
**WARNING**

When stepping onto a surface to enter the cab or access the deck plate, only use the steps and grab handles installed and designed for that purpose. Failure to use the proper steps and grab handles could cause a fall which may result in death or personal injury.

**NOTE**

Any alteration (adding bulkheads, headache racks, tool boxes, etc.) behind the cab that affects the utilization of installed grab handles, deck plates, or frame access steps should comply with Federal Motor Carrier Safety Regulation 399.

## How to Open the Hood

The hood is secured in its closed position by external latches, called Hold-downs, located on both sides of the hood. These Hold-downs keep the hood from opening

1

unexpectedly. Once the Hold-downs are unlatched, the hood may be tilted open.

### Unlatching Hood Hold-downs

#### Hood Hold-downs

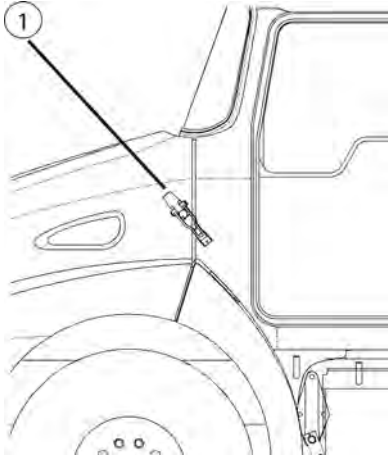

1. Hood Hold-down Latch

1. Pull the latch up and towards the hood.
2. Lift the latching mechanism out of its housing.
3. Rest the latching mechanism towards the cab.
4. Perform the above for both hood latches.

#### Tilting the Hood



#### WARNING

A hood could hurt someone in the way of its descent. Before lowering the hood, be sure there are no people or objects in the way.

1. Place one hand on the hood emblem, and keeping one foot on the ground, place a foot on the bumper.
2. Carefully, tilt hood forward.

### Close the Hood

The hood hold-open device will only be engaged if the vehicle hood is fully open. Once it is fully open, the latch will automatically engage and will need to be disengaged by the operator. The release lever for the hood hold-open device is located near the front hinge of the hood.

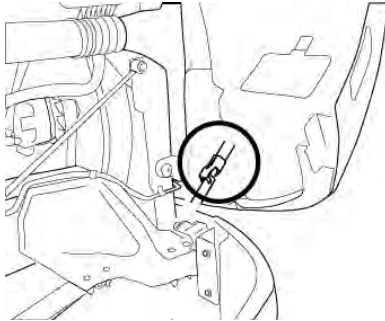

Pull the lever out to disengage the hood hold-open device.

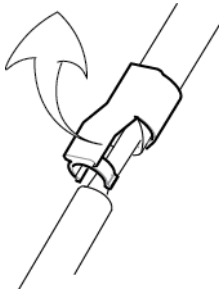

When closing the hood, be sure that you maintain the same point of contact (top of hood) to control the movement of the hood as it closes. Gently lower the hood into place to avoid damage to the hood or cab.

### WARNING

DO NOT let go of the hood while it closes. Close the hood in a controlled manner which requires hands firmly grasping the hood and feet on a stable, non-slip, surface. Failure to control the hood as it closes may result in death or personal injury

### WARNING

Always ensure the hood hold open latch is engaged to keep the hood fully open any time anyone gets under the hood for any reason. Failure to do so may cause the hood to close uncontrollably which may result in death or personal injury.

### WARNING

Before closing the hood, be sure the area is clear—no people or objects are in the way. Failure to do so may result in death or personal injury.

## Seat

This section covers the operation and safe use of your vehicles seats. For further information on features and adjustment of the seat, see the manufacturer's service and operator's manuals, included with the vehicle.

### Seat Adjustment

#### WARNING

DO NOT adjust the driver's seat while the vehicle is moving. The seat could move suddenly and unexpectedly and can cause the driver to lose control of the vehicle. Make all adjustments to the seat while the vehicle is stopped. After adjusting the seat and before driving off, always check to ensure that the seat is firmly latched in position. Failure to comply may result in property damage, personal injury, or death.

### Standard Driver's Seat

The standard driver's seat can be adjusted forward and rearward as well as up and

down. The seat back angle can also be adjusted. These three movements are each controlled by levers located either beneath or at the sides of the seat.

### Reclining Seats

Raise the seat all the way up so that the seat will tilt back and completely clear objects behind you.



#### WARNING

DO NOT drive or ride with your seat back in the reclined position. You could be injured by sliding under the seat belts in a collision. Failure to comply may result in personal injury or death.

### Safety Restraint Belts

Safety belts have proven to be the single most effective means available for reducing the potential for either death or personal injury in motor vehicle accidents. The combination lap/shoulder belt is equipped with a locking mechanism. The system adjusts automatically to a person's size and movements as long as the pull on the belt is slow. Hard braking or a collision

locks the belt. The belt will also lock when driving up or down a steep hill or in a sharp curve.

Unbelted riders could be thrown into the windshield or other parts of the cab or could be thrown out of the cab. They could strike another person. Injuries can be much worse when riders are unbelted. Always observe user warnings pertaining to safety belts. Your vehicle is equipped with a seat belt indicator lamp located on the dash.



#### WARNING

DO NOT drive vehicle without your seat belt and your passengers' belts fastened. Riding without a safety belt properly fastened can lead to injury or death in an emergency.



#### WARNING

DO NOT use the swivel function while a passenger is in the seat and the vehicle is in motion. The seat belt will not provide proper protection if the passenger is not facing forward and the vehicle is in an accident. Failure to

comply may result in death or personal injury.

### Correct Use of Restraint

#### Correct Placement of Lap Belt

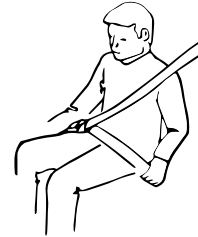

#### Correct Placement of Shoulder Belt



## Incorrect Use of Restraint

Lap Belt Too High on the Hip

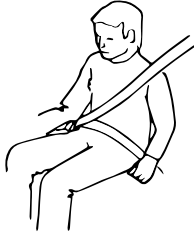

Shoulder Belt Incorrectly Under the Arm



Safety Restraint Belt Twisted



## During Pregnancy

Pregnant women should always wear combination lap/shoulder belts. The lap belt portion must be worn snugly and as low as possible across the pelvis. To avoid pressure on the abdomen, the belt must never pass over the waist. A properly worn seat belt may significantly reduce the risks to woman and baby in the event of a crash.



## Safety Restraint Tips

- DO NOT wear a belt over rigid or breakable objects in or on your clothing, such as eye glasses, pens, keys, etc., as these may cause injury in an accident.
- Any authorized person sleeping in your vehicle while it is moving should use the bunk restraint.
- Any authorized person sitting in the sleeper area on the sofa bed (if equipped) while it is moving should wear a seat belt.
- A responsible operator sees to it that everyone in the vehicle rides or sleeps safely. The operator is responsible to inform any passengers or co-drivers how to

- properly use the seat belts and bunk restraint in the vehicle.
- DO NOT strap in more than one person with each belt.
- Keep seat belt and bunk restraint buckles free of any obstruction that may prevent secure locking.
- Damaged or worn belts in the cab or sleeper subjected to excessive stretch forces from normal wear, must be replaced. They may not protect you if you are in an accident.
- Any belts or restraints that have been subjected to an accident should be inspected for any loose (attaching) hardware or damaged buckles.
- If belts show damage to any part of assembly, such as webbing, bindings, buckles or retractors, they must be replaced.
- DO NOT allow safety belts (seat or bunk) to become damaged by getting caught in door, bunk, or seat hardware, or rubbing against sharp objects.
- All belts must be kept clean or the retractors may not work properly.
- Never bleach or dye seat or bunk restraint belts: chemicals can weaken them. Do, however, keep them clean by following the care label on the belts. Let them dry completely before allowing them to retract or be stowed away.
- Make sure the seat belts and bunk restraint of the unoccupied passenger seat or bunk is fully wound up on its retractor or is stowed, so that the belt or restraint tongue is in its properly stowed position. This reduces the possibility of the tongue becoming a striking object in case of a sudden stop.
- DO NOT modify or disassemble the seat belts or bunk restraint in your vehicle. They will not be available to keep you and your passengers safe.
- If any seat belt or bunk restraint is not working properly, see an authorized dealer for repair or replacement.

### How to Use Lap/Shoulder Belt

Follow these steps to fasten your seat belt and be sure anyone riding with you does the same.



#### WARNING

Proper seat belt adjustment and use is important to maximize occupant safety. Failure to wear or adjust the safety belt properly may result in death or personal injury.

To fasten the belt:

1. Grasp the belt tongue.
2. Pull belt in a continuous slow motion across your chest and lap.
3. Insert belt tongue into buckle on inboard side of seat.
4. Push down until the tongue is securely locked with an audible click.
5. Pull belt to check for proper fastening and adjustment.
  - a. Pull shoulder section to make sure belt fits snugly across the chest and pelvis.

- b. There should be less than one inch (25 mm) gap between the body and the belt.
- c. The shoulder belt must be positioned over the shoulder, it must never rest against the neck or be worn under the arm.
- d. Make sure any slack is wound up on the retractor and that the belt is not twisted.

If the belt is locked, lean the body back to remove any tension in the belt. After releasing the belt, allow the belt to retract completely by guiding the belt tongue until the belt comes to a stop.

To unfasten the belt, push the release button on the buckle and the belt should spring out of the buckle. The seat belt indicator will turn off once the driver's seat

belt is fastened.

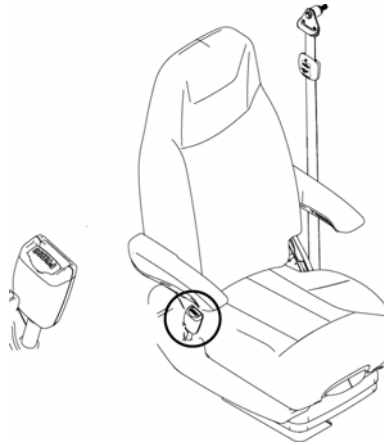

### Tether Belts

Make sure that the tether belt is attached to the cab floor and seat frame. It should be routed through the buckle on each side. Often the attachments are made using a split-type hook. Make sure both halves of the hook are around the anchor bracket.



### WARNING

DO NOT remove, modify, or replace the tether belt system with a different tether system. A failed or missing tether belt could allow the seat base to fully extend in the event of an accident. Failure to comply may result in death or personal injury.



### WARNING

Failure to adjust external tether belts properly can cause excessive movement of the seat in an accident. Tether belts should be adjusted so that they are taut when the seat is in its most upward and forward position. Failure to comply may result in death or personal injury.

Adjust an external tether by either lengthening or shortening the strap. To lengthen it:

1. Turn the buckle to a right angle to the webbing.
2. Then pull the buckle.

- To shorten the tether, pull on the strap.

### Komfort Latch Feature

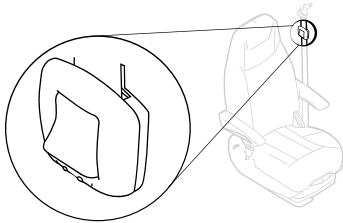

#### WARNING

DO NOT set the Komfort Latch with too much slack. Too much slack may reduce the effectiveness of the seat belt. Failure to comply may result in death or personal injury.

To eliminate cinching, simply activate the Komfort Latch device located on the seat belt webbing at the appropriate time:

- Adjust the seat to its proper driving position.
- Latch the seat belt.
- If available, adjust the seat belt height adjuster to a comfortable driving position.
- While seated appropriately, push the "on" button to engage the Komfort Latch.
- Lean forward in the seat until you hear a "click."
- Return to normal driving position, and the Komfort Latch maintains the preset amount of tension relief.

More information and video tutorials can be found at: <http://www.clicktugsnug.com/>  
To disengage the mechanism unbuckle the seat belt and then press the **OFF** button of the Komfort Latch or tug on the shoulder strap.

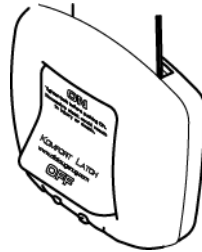

### Belt Damage and Repair

Damaged belts in the cab must be replaced. Belts that have been stretched, cut, or worn out may not protect you in an accident.

If any seat belt is not working properly, see an Authorized Service Center for repair or replacement.

For further information on seat belts and seat belt maintenance, see [Safety Restraint System - Inspection](#) on page 223.

### Vehicle Loading



#### WARNING

DO NOT exceed the specified load rating. Overloading can result in loss of vehicle control, either by causing component failures or by affecting vehicle handling. Exceeding load ratings can also shorten the service life of the vehicle. Failure to comply may result in death or personal injury.



**WARNING**

An unevenly distributed load or excessive load over one axle can adversely affect the braking and handling of your vehicle, which could result in an accident. Even if your load is under the legal limits, be sure it is distributed evenly. Failure to comply may result in death, personal injury, equipment or property damage.

The Gross Vehicle Weight Rating (GVWR) or the maximum front and rear Gross Axle Weight Ratings are determined by the components installed from the factory on to the vehicle and their designed specifications. (Axle weight ratings are listed on the driver's door edge.)

**GVWR** Gross Vehicle Weight Rating. This is the MAXIMUM WEIGHT your vehicle is allowed to carry, including the weight of the empty vehicle, loading platform, occupants, fuel, and any load. Never exceed the GVWR of your vehicle.

**GCW** Gross Combination Weight (GCW). This is the actual combined weight of your vehicle and its load: vehicle, plus trailer(s), plus cargo.

**GAWR**

Gross Axle Weight Rating. This is the total weight that one axle is designed to transmit to the ground. You will find this number listed on the driver's door edge.

**Load Distribution**

Be sure any load you carry is distributed so that no axle has to support more than its GAWR.

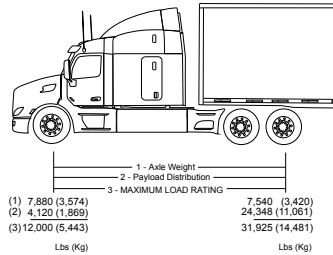

1. Axle Weight
2. Payload Distribution
3. Maximum Load Rating

Be sure that the load on the vehicle is distributed evenly across each axle so that no axle has to support more than its rated GAWR. In total, the vehicle and its load should not exceed the GAWR for each axle and must not exceed the GCW.

**Visual inspection while approaching the vehicle**

While approaching the vehicle, inspect the general appearance of the vehicle and its surroundings for any signs of needed attention.

**NOTE**

If equipped with a three-piece roof fairing, DO NOT DRIVE WITH ROOF FAIRING FOLDED DOWN, since the marker lamps will not be effective in that position.

Perform these basic inspection steps before operating the vehicle.

1. Check the overall appearance and condition. Are windows, mirrors, and lights clean and unobstructed?
2. Is the air-intake opening clear of obstructions?
3. Check beneath the vehicle. Are there signs of fuel, oil, or water leaks?
4. Check for damaged, loose, or missing parts. Are there parts

showing signs of excessive wear or lack of lubrication? Have a qualified mechanic examine any questionable items and repair them without delay.

5. Check your load. Is it secured properly?

## Daily Checks



### NOTE

These checks are in addition to, not in place of, Federal Motor Carrier Safety Regulations. These regulations may be purchased by writing to: Superintendent of Documents U.S. Government Printing Office Bookstore 710 N. Capitol St. N.W. Washington, DC 20402, or [ContactCenter@gpo.gov](mailto>ContactCenter@gpo.gov).

### Engine

- Engine oil
- Engine coolant
- Power steering fluid
- Engine belt

- Fuel filter (water separator) [Fuel System](#) on page 249
- Windshield washer fluid
- Battery cables - check the condition of the battery and alternator cables for signs of chafing or rubbing. Make sure that all clamps (straps) holding the cables are present and in good working order.
- Hood latch
- Brake lines and hoses
- Steering components - (pitman arm, drag link, tie rod, steering shaft, power steering hoses, etc.).
- Hydraulic clutch fluid

### Chassis and Cab Exterior

- Lights – are any exterior lights cracked or damaged? Perform an Exterior Lights Self Test (ELST) using the dash mounted rotary switch, next to the steering wheel (See [ELST](#)).



### NOTE

On certain vehicles equipped with LED technology, tail lights

may emit a faint glow when the door is open and the dome light is illuminated.

- Window and mirrors - clean and adjusted?
- Tires, wheels and hubs [Tires](#) on page 266 [Wheels](#) on page 269
- Suspension components - check for loose or missing fasteners. Check damage to springs or other suspension parts such as cracks, gouges, distortions, bulges or chafing.
- Brake lines and hoses - check lines, linkages, chambers, parking and service brake operation.
- Air system - [Air System](#) on page 204
- Steps and grab handles.
- Frame mounted tanks (fuel, diesel exhaust fluid, etc) - check underneath the vehicle for signs of fluid leaks. If any are found, correct before operating the vehicle. Is the tank fill cap secure? Are the tank straps tight? Is the strap webbing in place?
- Trailer connections - are they secure and the lines clear? If they are not being used, are they stored

properly? Is the trailer spare wheel secure and inflated? Is the landing gear up and the handle secured?

- Fifth wheel - Is the kingpin or the sliding fifth wheel locked?

### Cab Interior

- Seat - adjust the seat for easy reach of controls and visibility.
- Seat belts - fasten and adjust safety restraint belts (which may include restraints in the sleeper).
- Steering column - adjust for easy reach and visibility.
- Mirrors - check and readjust mirrors if necessary.
- Lamps - turn ignition key to the ON position to allow the bulb check and systems check to run. Resolve any issues. Perform an ELST to check the operation of exterior lights.
- Instruments - check all instruments. See [Systems Check](#) on page 26.
- Windshield - check operation of windshield wipers and washers.
- Horn - check operation of horn.
- Fuel - check vehicle's fuel level. Is there enough fuel?

- Diesel exhaust fluid - check level. Is there enough fluid?
- Air conditioning filters in the cab.

## Weekly Checks

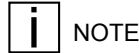

These checks are in addition to, not in place of, Federal Motor Carrier Safety Regulations. These regulations may be purchased by writing to: Superintendent of Documents U.S. Government Printing Office Bookstore 710 N. Capitol St. N.W. Washington, DC 20402, or [ContactCenter@gpo.gov](mailto>ContactCenter@gpo.gov).

### Engine

- Belts
- Hoses
- Clamps
- Radiator
- Air filter and its housing
- Engine Aftertreatment system components
- Exhaust pipes

- Engine air pre-cleaner (option) - For vocational vehicles with optional engine air pre-cleaner, check the purge valve at the bottom of the hood mounted engine air pre-cleaner for any obstructions. Make sure the purge valve will open and close as needed to purge dirt and water from the engine intake air.
- Automatic transmission fluid (where applicable) - Check level, after the engine has warmed up to operating temperature.

### Chassis and Cab Exterior

- Battery - check battery and terminals.
- Wheel cap nuts - are they all in place and torqued properly - tighten if necessary. [Wheels](#) on page 269
- Controls and wiring - check for condition and adjustment
- Steering components - check pitman arm, drag link, intermediate shaft U-joint pinch bolt, tie rod, steering shaft and power steering hoses, etc., for loose, broken, or missing parts.

- Cab air conditioner fresh air filter - check for condition and cleanliness.
- PACCAR 20k Front Axle Kingpin Joint Grease/Tie Rod Ends (option) (VOCATIONAL USE) - For vocational vehicles with this axle, grease with Heavy-Duty Multipurpose Lithium Based: #1 or #2 grade, every 50 hours. (Refer to [Front Axle and Suspension](#) on page 252 for maintenance instructions.)

## Systems Check

Systems Check evaluates each monitored system and shows the progress of that check on the display. The Systems Check will appear when the Exterior Lighting Self-Test (ELST) is activated (see [Exterior Lighting Self-Test \(ELST\)](#) on page 103), or when viewing the Notifications sub-menu (see [Menu](#) on page 74).

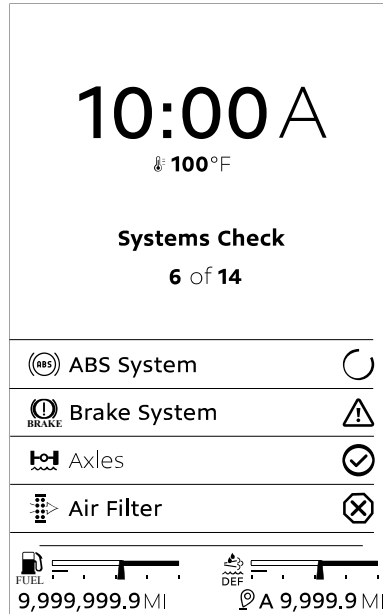

This Systems Check example illustrates the following conditions:

- ABS System – Check in process
- Brake System – Non-critical issue
- Axles – Ok (no issues)
- Air Filter – Critical issue

Once the Systems Check has completed, the results will display in a summary. A detailed explanation of this summary can be viewed by accessing the menu after a Systems Check has completed.

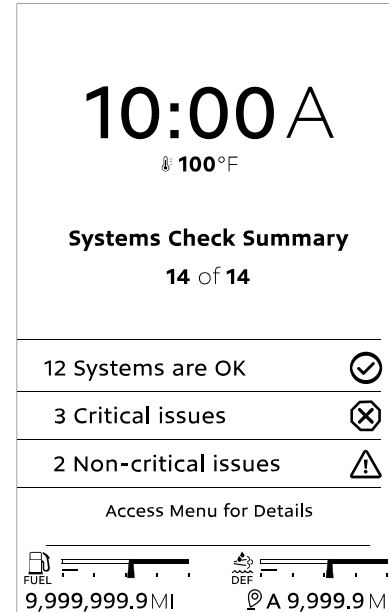

Systems Check can be interrupted at any time by

- Pressing **Select**.
- Switching the exterior lights OFF.
- Turning the ignition key to OFF or ACC.
- Releasing the parking brake.

## Chapter 2 | EMERGENCY

Roadside Assistance.....	29
Low Air Alarm .....	29
Stop Engine Light.....	30
Low Oil Pressure.....	30
Check Engine Lamp Turns On.....	30
Engine is Overheating.....	31
How to Inspect and Replace a Fuse.....	32
Where are the Fuses Located?.....	34
How to Jump Start a Battery.....	34
How to Recover a Vehicle.....	36

## Roadside Assistance

Call toll-free to talk to someone at the PACCAR Customer Center.



### 1-800-4Peterbilt (800-473-8372)

The Customer Call Center is open 24/7-365 days a year and staffed with trained personnel (English and other languages if necessary), free of charge, to provide total roadside assistance. Their custom mapping system can locate the nearest Authorized dealers and Independent Service Providers (ISPs) based on the vehicle's location. In addition, the customer center can dispatch services for jump and pull starts, tires, trailers, fines and permits, chains, towing, hazardous clean-up, out of fuel (roadside), mechanical repairs, and preventive maintenance services. If they can't answer a specific question, they will direct you to a representative who can.

## Low Air Alarm



If this alarm turns on while parked or driving, be sure to perform these tasks:



### WARNING

If the air pressure falls below 60 psi (414 kPa) the spring brakes may stop the vehicle abruptly, which could cause an accident resulting in personal injury or death. Observe the gauges. If the warning alert comes on, do not continue to drive the vehicle until it has been properly repaired or serviced.



### NOTE

The instrument cluster gauges may appear, if hidden from view, change brightness and change color to bring attention to a particular system.

1. Slow down carefully.
2. Move a safe distance off the road and stop.
3. Place the transmission in neutral (park with automatic transmissions, if equipped) and set the parking brake.
4. Turn OFF the engine.
5. Turn ON the emergency flasher and use other warning devices to alert other motorists.

If the light and alarm do not turn off at start-up, DO NOT try to drive the vehicle until the problem is found and fixed.

## Stop Engine Light



This warning light illuminates when the engine has a serious problem. This is an emergency and the vehicle should be safely stopped at the soonest opportunity.



### WARNING

This should be considered an emergency. You should stop the vehicle as safely as possible and turn OFF the ignition. The vehicle must be serviced and the problem corrected before driving again. Failure to do so may cause severe engine or Diesel Particulate Filter damage, or cause an accident which may result in death or personal injury.

## Low Oil Pressure



### CAUTION

Continuing to operate your vehicle with insufficient oil pressure will cause serious engine damage. Failure to comply may result in equipment or property damage.

It is important to maintain oil pressure within acceptable limits. If oil pressure drops below the minimum psi (kPa) the oil pressure gauge will illuminate and change color. Additionally, the Stop Engine Lamp will turn red.



### NOTE

The instrument cluster gauges may appear, if hidden from view, change brightness and change color to bring attention to a particular system.

1. Slow down carefully.

2. Move a safe distance off the road and stop.
3. Place the transmission in neutral (park with automatic transmissions, if equipped) and set the parking brake.
4. Turn OFF the engine.
5. Turn ON the emergency flasher and use other warning devices to alert other motorists.
6. Wait a few minutes to allow oil to drain into the engine oil pan, and then check the oil level.
7. Add oil if necessary. If the problem persists, contact an authorized dealer as soon as possible.

## Check Engine Lamp Turns On



Vehicle should be serviced to correct the problem but the situation should not be considered an emergency. The vehicle can still be safely driven.



## Engine is Overheating



### CAUTION

The cooling system may overheat if the engine coolant is at the minimum level. A sudden loss of coolant, caused by a split hose or broken hose clamp could also lead to an overheat condition. Always inspect to ensure hoses and clamps are not cracked, worn, or loose. Failure to comply may result in equipment or property damage.



### NOTE

The system may also temporarily overheat during severe operating conditions such as:

- Climbing a hill on a hot day

- Stopping after high-speed/high-load driving
- Debris blocking air flow through the cooling module (radiator)

If the engine coolant temperature warning lamp comes on and the audible alarm sounds showing an overheat condition, or if you have any other reason to suspect the engine may be overheating, **DO NOT TURN OFF THE ENGINE** unless a low water warning device indicates a loss of coolant.

Follow these steps if the engine coolant temperature is rising, or the temperature is already above normal, and there are no other warning alarms displayed in the instrument cluster.



### NOTE

The instrument cluster gauges may appear, if hidden from view, change brightness and change color to bring attention to a particular system.

1. Reduce engine speed, or stop. When stopped, place the transmission in neutral (N) and set

the parking brake. Keep the engine running.



### WARNING

To reduce the chance of personal injury, vehicle damage, and/or death from overheated engines, which can result in a fire, never leave the engine idling without an alert driver present. If the engine does overheat, as indicated by the engine coolant temperature lamp, immediate action is required to correct the condition. Continued unattended operation of the engine, even for a short time, may result in serious engine damage or a fire. Failure to comply may result in death, personal injury, equipment or property damage.

**WARNING**

Removing the fill cap on a hot engine can cause scalding coolant to spray out and burn you badly. If the engine has been in operation within the previous 30 minutes, be very careful in removing the fill cap. Protect face, hands, and arms against escaping fluid and steam by covering the cap with a large, thick rag. DO NOT try to remove it until the surge tank cools down or if you see any steam or coolant escaping. Always remove the cap very slowly and carefully. Be ready to back off if any steam or coolant begins to escape. Failure to comply may result in death, personal injury, equipment or property damage.

**NOTE**

Keep the engine running at idle speed unless a warning icon turns on that requires the engine to be shut off.

2. Check to ensure the Oil Pressure Gauge reads normal.

3. Make sure the engine fan is turning by switching the **Engine Fan Switch** from AUTO to MAN (Manual).
4. Idle the engine to see if this reduces the coolant temperature. If the temperature does not begin to drop, shut off the engine and contact your nearest authorized dealer.
5. If the temperature begins to return to normal, allow the engine to idle 3 to 5 minutes before shutting it off. This allows the engine to cool gradually and uniformly.
6. If overheating came from severe operating conditions, the temperature should have cooled by this time. If it has not, stop the engine and let it cool before checking to see if the coolant is low.
7. Be sure the vehicle is parked on level ground or the readings may be incorrect. Check the coolant level at the coolant surge tank.

Check the coolant level after each trip when the engine has cooled. The coolant level should be visible within the surge tank. Add coolant if necessary.

## How to Inspect and Replace a Fuse

Turn the ignition off and turn all lights off. Locate the fuses in either the cab, sleeper, or main power fuse box.

All the electrical circuits have fuses to protect them from a short circuit or overload. If something electrical on your chassis stops working, the first thing you should check for is a blown fuse.

**WARNING**

DO NOT replace a fuse with a fuse of a higher rating. Doing so may damage the electrical system and cause a fire. Failure to comply may result in death, personal injury, equipment or property damage.

**CAUTION**

Never patch fuses with aluminum foil or wire. This may cause serious damage elsewhere in the electrical circuit, and it may cause a fire.

### CAUTION

If a circuit keeps blowing fuses, have the electrical system inspected for a short circuit or overload by an authorized dealer as soon as possible. Failure to do so could cause serious damage to the electrical system and/or vehicle.

### CAUTION

Before replacing a fuse, turn OFF all lights and accessories and remove the ignition key to avoid damaging the electrical system.

1. Turn off all lights and accessories and remove the ignition key to avoid damaging the electrical system.
2. Determine from the chart on the fuse panel which fuse controls that component.
  - If the circuit has a fuse, remove that fuse and see if it is blown.
  - If the circuit has a polyswitch, have your electrical system

inspected by an authorized dealer.

### Blown Fuse

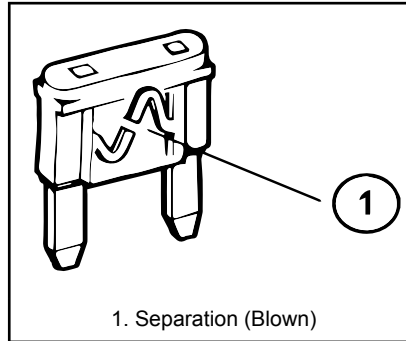

1. Separation (Blown)

3. If it is blown, replace it with a fuse of the same rating. If a fuse of the same rating is not available, a fuse of a lower rating may be temporarily substituted. You can also use a fuse from a circuit you can do temporarily without (for example an accessory circuit or radio).

### CAUTION

When replacing a failed polyswitch (circuit breaker), always use an approved polyswitch (circuit breaker) with a current rating equal to or less than the polyswitch (circuit breaker) being replaced. Only use the approved Type II modified reset polyswitch (circuit breaker). NEVER use a Type I (automatic reset) or Type III (manual reset) polyswitch (circuit breaker). A fuse with a current rating equal to or less than the polyswitch (circuit breaker) being replaced can also be used.

### CAUTION

Always close and latch the engine compartment fuse box cover. A latched cover ensures a water tight seal which can prevent damage to electrical components.

## Where are the Fuses Located?

Fuses for the cab are located in the fuse panel behind the drivers side kick panel. Main power relays are located on the power distribution center, in the engine compartment, mounted to the front wall of the cab.

## How to Jump Start a Battery

Jump starting a vehicle is not a recommended practice due to the various battery installations and electrical options. However, if the vehicle battery is discharged (dead), the vehicle may be jump started (using energy from a good battery in another vehicle).



### WARNING

Batteries contain acid that can burn and gases that can explode. Ignoring safety procedures may result in death,

personal injury, equipment or property damage.



### WARNING

Never jump start a battery near fire, flames, or electrical sparks. Batteries generate explosive gases that could explode. Keep sparks, flames, and lighted cigarettes away from batteries. Failure to comply may result in property damage, personal injury, or death.



### WARNING

Never remove or tamper with battery caps. Ignoring this could allow battery acid to contact eyes, skin, fabrics, or painted surfaces. Failure to comply may result in death, personal injury, equipment or property damage. Be careful that metal tools (or any metal in contact with the positive terminal) do not contact the positive battery terminal and any other metal on the vehicle at the same time. Remove metal jewelry and avoid leaning over the battery.



### WARNING

When jump starting using a battery charger/booster, verify that the battery charger/booster is set to the same jump start voltage and amperage specifications as the vehicle electrical system and batteries (i.e., if the vehicle electrical system is a 12 volt system, the jump start voltage on the battery charger/booster shall be set at no higher than a 12 volt setting). Failure to comply may cause an explosion and/or fire resulting in death, personal injury, and/or equipment or property damage.



### WARNING

Heed all warnings and instructions of the jumper cable manufacturer. Failure to comply may result in death, personal injury, equipment or property damage.

**CAUTION**

Applying a higher voltage booster battery will cause expensive damage to sensitive electronic components, such as relays and the radio. Failure to comply may result in equipment damage.

**CAUTION**

Improper hook-up of jumper cables or not following these procedures can damage the alternator or cause serious damage to both vehicles.

1. Remove any jewelry that may come in contact with the battery terminals.
2. Select a jumper cable that is long enough to attach to both vehicles in a way that ensures neither vehicle touches each other.
3. Position the two vehicles together, but do not allow them to touch.
4. Turn OFF all lights, heater, radio, and any other accessory on both vehicles.

5. Set the parking brake.
6. Shift the transmission into park position or neutral for manual transmissions.
7. If either vehicle is equipped with battery disconnects ensure they are in the OFF position prior to connecting the two vehicles.
8. Attach one end of a jumper cable to the positive (+) terminal of the discharged (dead) battery. This will have a large red + or P on the battery case, post, or clamp.
9. Attach the other end of the same cable to the positive (+) terminal of the good (booster) battery.
10. Attach the remaining jumper cable FIRST to the negative (-) terminal (black or N) of the good battery.
11. Attach the other end of the negative cable to a bare metal part not bolted to the engine block.

**NOTE**

Always connect positive (+) to positive (+) and negative (-) to negative (-).

12. If either vehicle is equipped with battery disconnects, ensure that they are in the ON position.
13. Start the vehicle that has the good battery first. Let it run for 5 minutes.
14. Start the vehicle that has the discharged (dead) battery.

The engine should start. If the engine fails to start, do not continue to crank the starter. Instead, contact the nearest authorized dealer.

**WARNING**

When disconnecting jumper cables, make sure they do not get caught in any moving parts in the engine compartment. Failure to comply may result in death, personal injury, equipment or property damage.

Reverse the above procedure exactly when removing the jumper cables. With engine running, disconnect jumper cables from both vehicles in the exact reverse order, making sure to first remove the negative cable from the vehicle with the discharged battery.

## How to Recover a Vehicle



### CAUTION

Remove the drive axle shafts or lift the driving wheels off the ground before towing the vehicle. Towing the vehicle with either the wheels on the ground or the axle shafts in the axles will cause damage to the axle gears.



### CAUTION

If your vehicle has a Meritor axle with a driver-controlled main differential lock, install the caging bolt before removing the axles for towing, see How to Manually Lock a Differential. Installing the caging bolt prevents damage by locking internal axle components in position.



### CAUTION

Connect recovery rigging only to hitch-eyes intended for that purpose. **DO NOT**

attach to bumpers or brackets. Use only equipment designed for this purpose. Failure to comply may result in equipment damage.



### WARNING

Before towing a vehicle, test your air brakes to ensure that you have properly connected and inspected the recovery vehicle's brake system. Failure to do so could lead to a loss of vehicle control which may result in an accident involving death or personal injury.

All lubricating and clutch application oil pressure is provided by an engine-driven pump, which will not work when the engine is stopped. You could seriously damage your vehicle by towing it with the driveline connected and the drive wheels on the ground. Worse, when vehicles are towed, either by wrecker or piggyback, the lubricant in the top front of the drive axle will drain to the rear. This will leave the top components dry. The resulting friction may damage them. Always remove the main drive axle shafts before towing your vehicle.

1. Review and understand all the cautions and warnings of this section.
2. Disconnect the drive axle shafts and cover the open hubs. This is necessary because if the transmission is driven by the driveshaft (rear wheels on the ground), no lubricant will reach the gears and bearings, causing damage to the transmission. .

See [How to Prepare the Axles for Towing](#) on page 39

3. Connect the towing chain or cable using best recovery practices .

See [Best Practices for Recovery Rigging](#) on page 41

4. Make sure the recovered vehicle's parking brakes are released. .

See [Manually Release the Parking Brake](#) on page 37

5. If you desire to use the recovered vehicle's brakes, ensure that the vehicle's air system is connected to that of the recovery vehicle. Ensure that any air line that has been removed from a driver-controlled main differential lock is firmly capped to prevent loss of air pressure from the recovery vehicle

if it is supplying air pressure. If you don't desire to use the recovered vehicle's brakes, ensure that you cage the spring brakes before attempting to move the vehicle.

See [How to Manually Lock a Differential](#) on page 40

6. Follow state/provincial and local laws that apply to vehicles in tow.
7. Do not tow vehicles at speeds in excess of 55 mph (90 km/h).

For additional information concerning heavy duty truck recovery, refer to the following Technology & Maintenance Council (TMC) literature.

- Recommended Practice #602-A — "Front Towing Devices For Trucks and Tractors"
- Recommended Practice #602-B — "Recovery Attachment Points For Trucks, Tractors, and Combination Vehicles"
- Recommended Practice #626 — "Heavy Duty Truck Towing Procedures"

Copies of these can be obtained from the following address: Technology & Maintenance Council 950 N. Glebe Road (703) 838-1763 Arlington, VA 22203  
Email:

tmc@trucking.org Website: <http://tmc.truckline.com>

### Manually Release the Parking Brake

There may be times when there is not enough air pressure, or the engine's air compressor is not able to produce enough pressure, to release the parking brakes. In such cases, the parking brakes (or Spring Brakes) can be manually released.



#### WARNING

DO NOT drive vehicle with malfunctioning brakes. If one of the brake circuits becomes inoperative, braking distances will increase substantially and handling characteristics while braking will be affected. You could lose control of your vehicle or cause an accident. Have it towed to the nearest dealer or qualified repair facility for repair. Failure to comply may result in property damage, personal injury, or death.



#### WARNING

DO NOT operate a vehicle when the spring brakes have been manually released. Driving a vehicle after its spring brakes are manually released is extremely dangerous. The brakes may not function. Failure to comply may result in death, personal injury, equipment or property damage.



#### WARNING

DO NOT disassemble a spring brake chamber. These chambers contain a powerful spring that is compressed. Sudden release of this spring may result in death or personal injury.



**WARNING**

Releasing the spring brakes on an unsecured vehicle could lead to an accident. The vehicle could roll, which may result in death, personal injury, equipment or property damage. Always secure the vehicle with wheel chocks, chains, or other safe means to prevent rolling before manually releasing the spring brakes.

2

To move a vehicle immobilized by the spring brakes due to loss of air pressure in the brake system, perform the following procedure:

1. Remove the cap from the spring chamber



2. Remove the release stud assembly from the side pocket, and remove the release nut and washer from the release stud.

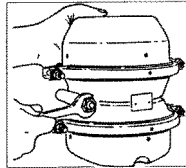

3. Slide out the release stud.

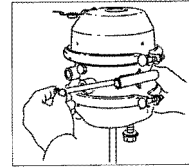

4. Insert the release stud through the opening in the spring chamber where the cap was removed. Insert it into the pressure plate. Turn the release stud 1/4 turn clockwise in the pressure plate. This secures the cross pin into the cross pin area of the pressure plate and locks it into the manual release position.

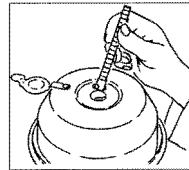

5. Assemble the release stud washer and nut on the release stud.



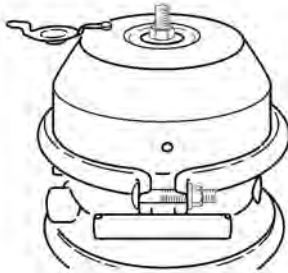

6. With a wrench, turn the release stud assembly nut until the compression spring is 90-95 percent caged. While doing this, check to make sure the push rod (adapter push rod or service push rod) is retracting. DO NOT over-torque the release stud assembly. (S-Cam-type maximum: 50 lb-ft (68 N·m), Wedge-type maximum: 30 lb-ft (41 N·m)). The spring brake is now mechanically released.

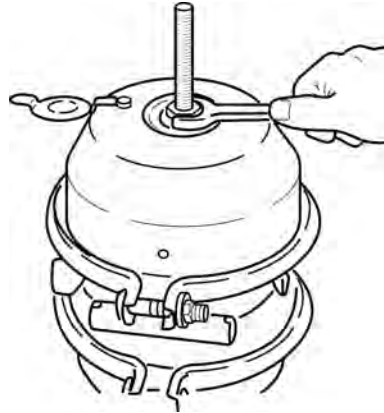

### How to Prepare the Axles for Towing

If the vehicle is going to be towed from the front axle and using the rear axle for support, then the axle shafts should be prepared [removed] so that minimal damage is made to the differential during the towing process.

Ensure that the recovered vehicle does not have an open air line. An open air line on the recovered vehicle will cause a leak in the air system of the recovery vehicle if both vehicles' brake systems are

connected. This could cause a loss of system air, which can cause the service brakes not to function, resulting in the sudden application of the spring brakes causing wheel lock-up, loss of control, or overtake by following vehicles.



### WARNING

An open air line on the recovered vehicle will cause a leak in the air system of the recovery vehicle if both vehicles' brake systems are connected. This could cause a loss of system air, which can cause the service brakes not to function, resulting in the sudden application of the spring brakes causing wheel lock-up, loss of control, or overtake by following vehicles. You could be in an accident involving personal injury or death. Ensure that any air line that has been removed from a driver-controlled main differential lock is firmly capped to prevent loss of air pressure from the recovery vehicle if it is supplying air pressure.

1. Lift driving wheels off the ground or remove the driveline and axle shafts before towing the vehicle.

**CAUTION**

Failure to lift the driving wheels off the ground or remove the driveline and axle shafts before towing the vehicle could seriously damage your vehicle. All lubricating and clutch application oil pressure is provided by an engine-driven pump, which does not work when the engine is stopped. When vehicles are towed either by wrecker or piggyback, lubricant in the top front of the drive axle will drain to the rear. This will leave the top components dry, resulting in friction that will seriously damage these components.

2. If the vehicle has driver controlled differential lock, then manually lock the differential.
3. Remove drive axle shafts.
4. Cover the open ends of the hubs to prevent dirt and debris from entering the axle.

**CAUTION**

Water, dirt, and other material can enter an open hub or axle. This can con-

taminate the axle fluid and cause possible damage to components. Ensure that the hubs are covered with plastic whenever a drive axle shaft is removed.

**How to Manually Lock a Differential**

Follow these procedures if the vehicle has a driver controlled differential lock. Always lock the differential when the axles are being removed to aid in re-installation. This procedure should be done before the axle shafts are removed.

**CAUTION**

Failure to install the caging bolt when towing vehicles with driver-control main differential lock can result in damage by failing to lock internal components in position.

**WARNING**

An open air line on the recovered vehicle will cause a leak in the air system of the recovery vehicle if both vehicles' brake systems are connected. This

could cause a loss of system air, which can cause the service brakes not to function, resulting in the sudden application of the spring brakes causing wheel lock-up, loss of control, or overtake by following vehicles. You could be in an accident involving personal injury or death. Ensure that any air line that has been removed from a driver-controlled main differential lock is firmly capped to prevent loss of air pressure from the recovery vehicle if it is supplying air pressure.

**CAUTION**

A recovered vehicle will have no operational brake system. Additionally, the rear axle spring brakes will probably be applied.

- If you desire to use the recovered vehicle's brakes, ensure that the vehicle's air system is connected to that of the recovery vehicle. Also ensure that any air line that has been removed from a driver-controlled main differential lock is

firmly capped to prevent loss of air pressure from the recovery vehicle.

- If you don't want to use the recovered vehicle's brakes, ensure that you cage the spring brakes before attempting to move the vehicle.

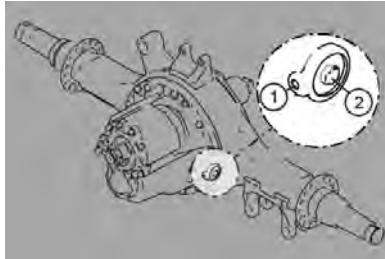

- Remove the air line and firmly cap the air line from the vehicle. (2)
- Remove the caging bolt from its storage hole. (1)
- Screw the caging bolt into the air line hole. (2)
- When fully engaged, a 0.25-0.5 in. (6.35-12.7 mm) space will remain between the air cylinder and the bolt head. This action will lock the differential by pushing a piston into a "lock" position.

### Best Practices for Recovery Rigging



#### CAUTION

Recovery pull maximums assume the tow rigging evenly distributes the load between both recovery hitches. See examples in Recovery Rigging for details. Serious damage to the vehicle may occur if rigging is not connected properly.



#### CAUTION

When recovering ditched or bogged vehicles, stay well below Maximum Capacities. Even at loads below maximum, the physical strain of recovering a vehicle could damage axles, suspensions, fifth wheels, etc.

### Recovery Rigging Options

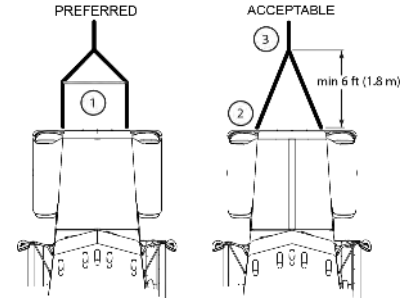

Use a double chain or cable setup that distributes the load equally to both hitches (see either example in Recovery Rigging Options illustration):

- Never loop a single chain or cable through both hitches, also known as reeving (not shown).
- Use a spreader or equalizer bar to distribute the load on both hitches (1), or
- If no spreader bar is available, connect the main tow chain or cable no closer than 6 ft. (1.8 m) from the vehicle: (2) to (3).
- Secure the towed vehicle using two additional chains or cables (see *Safety Chains*) (not shown).

## Returning to Service After Recovering

Once the vehicle is recovered, the axles need to have oil added to prevent gear damage during operation.

1. Into the pinion cage, add 1 pint (.47 liter) of lubricant or into the interaxle differential, add 2 pints (.94 liter) of approved lubricant.
2. After adding the specified type and amount of lubricant, drive the vehicle. It should be unloaded. Drive 1 to 2 miles (1.5 to 3 km) at a speed lower than 25 mph (40 km/h). This will thoroughly circulate the lubricant through the assembly.
3. If the parking brakes were manually released, they will need to be modified back to their normal operating condition.
4. If the differential lock was manually locked, then the caging bolt needs to be put back in its storage location and the differential lock air line needs to be re-installed in its normal position.

Add lubricant back to the axles after recovering the vehicle and before putting it back into service.

## What to do if the Vehicle is Stuck in Sand, Mud, Snow or Ice



### WARNING

DO NOT spin the wheels faster than 35 mph (55 km/h). Spinning a tire at speedometer readings faster than 35 mph (55 km/h) can be dangerous. Tires can explode from spinning too fast. Under some conditions, a tire may be spinning at a speed twice that shown on the speedometer. Any resulting tire explosion could cause injury or death to a bystander or passenger, as well as extensive vehicle damage: including tire, transmission, and/or rear axle malfunction.

These suggestions are provided to improve the ability to free a vehicle if the vehicle gets stuck in sand, mud, snow, or ice:

- Move the gearshift lever or selector from First to Reverse
- Apply light pressure on the accelerator pedal while the transmission is in gear
- Remove your foot from the accelerator while shifting
- Do not race the engine

- For best traction and safety, avoid spinning the wheels

Follow these practices to avoid transmission damage:

- Always start vehicle in motion with the shift lever in first gear.
- Be sure that transmission is fully engaged in gear before releasing the clutch pedal (manual only).
- Do not shift into reverse while the vehicle is moving.
- If the vehicle needs to be recovered from being stuck, do not permit the vehicle to be towed for long distances without removing the driveshaft.

If tire chains are needed, make sure they are installed on both sides of the driving axle. Installing chains on only one side of the axle can cause equipment damage.

**CAUTION**

Chains on the tires of only one tandem axle can damage the driveline U-joints and the inter-axle differential. Repairs could be costly and time-consuming. Failure to comply may result in equipment damage.

- If towing from the front, ensure that the rear axles are prepared for towing
- If towing from the rear, ensure that all body components such as roof, side, and chassis fairings are secured properly to avoid damage while in transit

**WARNING**

Secure the roof, side, and chassis fairings while towing from the rear. An unsecured fairing may come off of the vehicle during transit. Failure to secure the fairings while towing may cause an injurious accident resulting in death or personal injury.

**Towing the Vehicle**

A dealer or commercial towing service will have the necessary equipment to safely tow the vehicle and should be able to make arrangements to limit any damage to the vehicle. The towing service and the dealer should be aware of towing regulations and safety precautions.

The towing service will ensure that the following precautions are taken:

- Use of a safety chain system
- Abide by all local towing regulations
- Ensure that the towing device does not contact any surfaces that could be damaged while in transit

## Chapter 3 | CONTROLS

3

Instrument Panel.....	46
Gauges.....	47
Warning Lights and Indicators.....	48
Menu Control Switch.....	63
Steering Wheel Controls (Option).....	63
Exterior Lights Switch (ELS).....	66
Peterbilt Digital Display.....	67
Display Notifications.....	69
Views.....	70
Menu.....	74
Post Trip.....	77
Dash Switches.....	77
Steering Column Controls.....	96
Door Mounted Mirror Controls.....	101
Ignition Key Switch.....	103
Exterior Lighting Self-Test (ELST).....	103

Heating and Air Conditioning..... 104  
Cab Accessories..... 111

## Instrument Panel

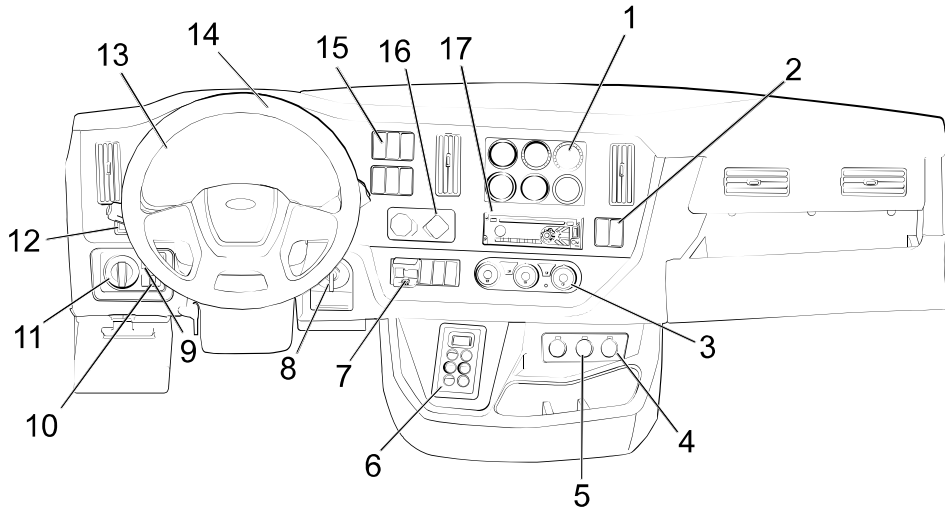

1. Optional Gauges
2. Dash Switches
3. A/C Controls
4. 12V Outlet
5. 12V Outlet
6. Shifter (push button shifter shown)
7. Compact Trailer Valve
8. Ignition
9. Hazard Switch
10. Dimmer Switch
11. Exterior Lights Switch (ELS)
12. Signal Stalk
13. Peterbilt Digital Display
14. Steering Wheel
15. Dash Switches
16. Parking Brakes (air operated)
17. Radio Stereo System



## Gauges

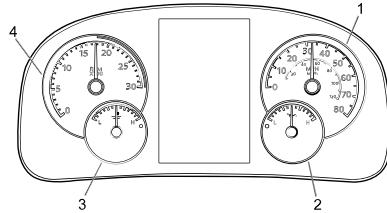

1. Speedometer
2. Engine Oil Pressure
3. Engine Coolant Temperature
4. Tachometer

### Speedometer

The Speedometer indicates the vehicle speed in miles per hour (mph) and in kilometers per hour (km/h).

### Engine Oil Pressure



#### CAUTION

Continuing to operate your vehicle with insufficient oil pressure will cause seri-

ous engine damage. Failure to comply may result in equipment or property damage.

The Engine Oil Pressure gauge monitors the oil pressure providing coolant to the Engine. It is important to maintain oil pressure within acceptable limits. If oil pressure drops below the minimum PSI/kPa, the Stop Engine warning light will illuminate, a Popup will appear (see [Popups](#) on page 69), and an audible alarm will sound.

If the oil pressure fails to rise within 10 seconds of starting the engine, stop the engine and determine the cause. Check the engine manufacturer's manual for the correct oil pressure ranges for your vehicle's engine. If the oil pressure suddenly drops, or the audible alarm and engine oil pressure telltale (see [Low Oil Pressure](#) on page 30) come on while driving, safely stop the engine and address the issue. For further information on engine gauges and operating your engine properly, see [Engine Maintenance](#) on page 241.

### Engine Coolant Temperature

The Engine Coolant (water) Temperature gauge indicates the temperature of the engine coolant.

If the coolant temperature exceeds the maximum limits, a red warning lamp in the gauge will turn on and an audible warning will sound. If the coolant temperature continues to rise, the Check Engine and/or Stop Engine lights will also come on.



#### CAUTION

This should be considered an emergency. You should stop the vehicle as safely as possible and turn OFF the ignition. The vehicle must be serviced and the problem corrected before driving again. Failure to do so may cause severe transmission damage.

Under normal operating conditions, the water temperature gauge should register between 165° and 205° F (74° and 90° C). Under certain conditions, somewhat higher temperatures may be acceptable. The maximum allowable temperature is 220° F (104° C) with the cooling system pressurized, except for certain engines. Check the engine manual to be sure.

### Tachometer

The rpm detail is also available as a viewable screen in the instrumentation cluster as a virtual gauge. The tachometer is a useful gauge when attempting to drive efficiently. It will let you match driving speed and gear selection to the operating range of your engine. If the engine speed gets too high, you can select a higher gear to lower the rpm. If the engine speed drops too low, you can select a lower gear to raise the rpm. To avoid engine damage, do not let the pointer exceed maximum governed engine speed. (See your Engine Operation and Maintenance Manual for rpm recommendations.)

### Digital Gauges

If a gauge has a red zone (representing a gauge region outside of a components normal operating range), it is indicated by a horizontal red line.



Gauges that enter a red zone will enlarge and turn red. If the gauge value rises into this zone, this boundary will indicate with a

white line, if it lowers, it indicates with a red line.



Gauges that stop receiving input from the systems they monitor, will display the text “Data Error” and turn gray, with critical gauges instead, turning red. Gauges displaying “Data Error” will stop presenting values reflecting the systems they monitor.

### Optional Gauges

Optional physical gauges will be located to the right of the Display.

## Warning Lights and Indicators

The instrument panel communicates many vehicle conditions using warning lights (also called telltales), indicators, and audible alarms. Some conditions are communicated for informational purposes only – indicators – while warning lights often require an operator response and are sometimes accompanied with a popup (see [Popups](#)).

## Warning Lights

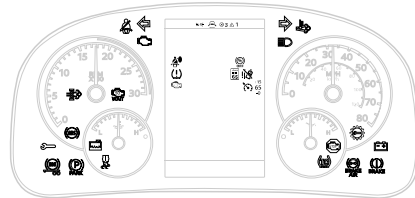

### Introduction

Warning Lights (Telltales), Indicators and audible alarms may indicate a system malfunction. They should be checked frequently and responded to promptly as soon as they are noticed. These indications could save you from a serious accident. Additionally, gauges may become visible on the Digital Display and may change color or brightness to bring the gauge to the operator's attention. Warning Lights and Indicators are shown on the instrument cluster, drawing attention to the component it monitors. Some of these indications also show an associated

popup, providing additional information (see *Popups*). Red and amber popups are tallied at the top of the display and can be viewed in the Notifications sub-menu when the parking brake is set (see *Notifications*). In some cases, you may have both an alarm or warning tone accompanied by an Indicator or Warning Lights.







Some warnings can be managed by the operator while others may require an authorized dealer repair. The following table lists the Warning Lights and Indicators that appear on the instrument cluster. Each indication in this table has a unique name and symbol, and list the illuminated color. The table also lists whether the symbol is standard (Std) or optional (Opt). Optional indications require the vehicle to have a specific component installed.







 **WARNING**







Do not ignore any type of tone or lights. These signals tell you that something is malfunctioning on your vehicle and provide you an indication of what system is affected. It could be a failure of an important system, such as the brakes, which could lead to an accident and may result in property damage, personal injury, or death.







**Indications**







Indication Name	Symbol	Color	Standard	Option
<i>Anti-Lock Brake System (ABS)</i> on page 55		Yellow	•	

Indication Name	Symbol	Color	Standard	Option
<i>Anti-Lock Brake System (ABS), Trailer</i> on page 55		Yellow	•	
<i>Axle, Stability Control (Option)</i> on page 56		Yellow	•	
<i>Axle, Traction Control</i> on page 57		Yellow	•	
<i>Check Transmission</i> on page 57		Red		•
<i>Diesel Particulate Filter (DPF) Warning Light</i> on page 58		Yellow	•	
<i>Differential, Inter-Axle Lock</i> on page 58		Green		•
<i>Dump Truck, Body Up</i> on page 58		Red		•

Indication Name	Symbol	Color	Standard	Option
<i>Dump Truck, Trailer Body Up</i> on page 58		Red		•
<i>Engine BrakeSaver or Transmission Retarder</i> on page 58		Yellow		•
<i>Engine, Check Engine</i> on page 59		Yellow	•	
<i>Engine, Brake ON/OFF</i> on page 58		Green		•
<i>Engine, Brake Level</i> on page 58		Yellow		•
<i>Engine, Engine Block Heater</i> on page 59		Yellow		•
<i>Engine, Low Coolant Level</i> on page 59		Yellow	•	

Indication Name	Symbol	Color	Standard	Option
<i>Engine, Overspeed</i> on page 59		Red		•
<i>Engine, Retarder (Brake)</i> on page 59		Green		•
<i>Engine, Stop Engine</i> on page 59		Red	•	
<i>Engine, Wait To Start</i> on page 60		Yellow		•
<i>Emissions, High Exhaust System Temperature</i> on page 60		Yellow	•	
<i>Emissions, Engine Derate</i> on page 60		Yellow	•	
<i>Fifth Wheel Locked</i> on page 60		Green		•

Indication Name	Symbol	Color	Standard	Option
<i>Fifth Wheel Slide Unlocked</i> on page 61		Red		•
<i>Fifth Wheel Unlocked</i> on page 61		Red		•
<i>Hill Hold (Eaton Ultrashift Plus)</i> on page 61		Yellow		•
<i>Lane Departure Warning (LDW)</i> on page 61		Yellow		•
<i>Lights, High Beam</i> on page 61		Blue	•	
<i>Malfunction Indicator Lamp (MIL)</i> on page 62		Yellow		•
<i>Message Waiting</i> on page 62		Green		•

Indication Name	Symbol	Color	Standard	Option
<i>Park Brake</i> on page 62		Red	•	
<i>Seat Belt, Fasten</i> on page 62		Red	•	
<i>Transmission, Oil Temperature High</i> on page 62		Yellow		•
<i>Turn Signal, Left</i> on page 62		Green	•	
<i>Turn Signal, Right</i> on page 63		Green	•	
<i>Worn brake</i> on page 63		Red		•



**Anti-Lock Brake System (ABS)**



Illuminates during the Bulb Check (See [Bulb Check](#) on page 68). Have the ABS checked by an authorized dealer if the ABS Warning Lamp stays on for more than 3 seconds.

- Illuminates during normal operating conditions to indicate a problem with the ABS.
- Illuminates when a problem exists with Automatic Traction Control (ATC).

See also Automatic Traction Control on page 4-33.

	<b>NOTE</b>
<p>After servicing the ABS, the lamp stays on after the power-on self test. This indicates that the ABS wheel sensors have not been checked by the ABS. As soon as the vehicle is driven at speeds above 4 mph (6 km/h) the lamp turns off, indicating that the wheel sensors have been checked by the ABS.</p>	

**Anti-Lock Brake System (ABS), Trailer**

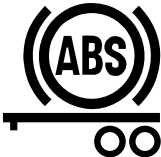

1. It illuminates during the power-on self test when the ignition is turned ON. It turns off after a few seconds if no system problems are detected. The bulb self-test is performed whenever the ignition is turned ON, regardless of whether you have Trailer ABS. If a Trailer ABS system is detected, the lamp will turn off after a few seconds if no system problems are detected.

	<b>NOTE</b>
<p>If the Trailer ABS Warning Lamp does not turn on during the power-on self test, there may be a problem with the light or wiring. You should have this checked as soon as possible.</p>	

2. If it turns on at any other time, it is indicating that a problem exists with the Power Line Communication (PLC) trailer ABS. This should be checked by an authorized dealer as soon as possible. (Refer to "Trailer ABS" in the Operator's Manual for more information.)
3. If your tractor and trailer have the "Special Trailer ABS (Without PLC) Option," (Refer to "Special Trailer ABS (Without PLC) Option" in the Operator's Manual for more information.) this lamp will turn on when the trailer ABS has a system problem. This should be checked by an authorized dealer as soon as possible. Power on self test for trailer ABS is controlled by the cluster and occurs under all conditions.



**NOTE**

If the Trailer ABS Warning Lamp does not turn on during the power-on self test, there may be a problem with the light or wiring. You should have this checked as soon as possible.



**NOTE**

Tractors/Trucks and trailers built after 03/01/2001 must be able to turn on an In-Cab Trailer ABS Warning Light (per U.S. FMVSS121). The industry chose Power Line Communication (PLC) as the standard method to turn it on. On trailers built prior to 03/01/2001 verify trailer ABS system status via the required external warning light mounted on the trailer. The indicator light on the trailer should be yellow and identified with the letters ABS.



**NOTE**

The Trailer ABS Warning Lamp will not turn on when connected to trailers with

ABS (but without PLC) powered through the primary 7-way trailer light line. Use the lamp on the driver's side of the trailer to identify trailer ABS problems.



**NOTE**

For doubles or triples, the lamp does not distinguish between trailers. An ABS problem in any of the trailers will activate the Trailer ABS Warning Lamp.

**Axle, Stability Control (Option)**

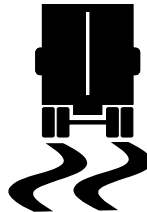

Calculates the driver's intended path of travel from wheel speed and steering angle sensors, then compares calculations to the actual direction of travel. The system uses

individual wheel brakes to re-adjust the path of the vehicle.

- The Stability Control Icon (ESC or Electronic Stability Control) illuminates during the Bulb Check when the ignition is turned ON. It turns off after a few seconds if no system problems are detected. If a problem is detected, the ESC Warning lamp will turn on and stay on.
- Illuminates when the ESC system is regulating individual wheel brakes to correct the vehicle's direction of travel. (Refer to Advanced ABS with Stability Control for more information.)

 **WARNING**

If this chassis is equipped with an Electronic Stability Control (ESC) and is modified (e.g. adding or removing an axle, converting from a truck to a tractor, converting from a tractor to a truck, changing the body, lengthening of the wheelbase and/or frame, relocating frame components, or modifying pneumatic or electrical ABS/ESC harnesses) the ESC must be evaluated by a qualified technician. If you have any questions, contact your authorized dealer. Failure to comply may result in property damage, personal injury, or death.

 **NOTE**

For more information about the stability control system installed on your vehicle, please refer to additional material supplied with this operator manual, included in your glove box informational packet.

**Axle, Traction Control**



Monitors wheel speed for poor traction. If a wheel begins to slip due to poor traction, it may reduce engine power or apply brakes in an effort to regain traction.

- Illuminates during the Bulb Check when the ignition is turned ON. It turns off after a few seconds if no system problems are detected. If an ATC problem is detected, the ATC warning light will turn on and stay on.
- Illuminates when the ATC is regulating wheel spin and turns off after the traction control event has ended.
- Flashes continuously when the ATC/Deep Snow & Mud switch is turned on, indicating that this feature is active.

 **WARNING**

If this chassis is equipped with an Electronic Stability Control (ESC) and

is modified (e.g. adding or removing an axle, converting from a truck to a tractor, converting from a tractor to a truck, changing the body, lengthening of the wheelbase and/or frame, relocating frame components, or modifying pneumatic or electrical ABS/ESC harnesses) the ESC must be evaluated by a qualified technician. If you have any questions, contact your authorized dealer. Failure to comply may result in property damage, personal injury, or death.

 **NOTE**

For more information about the stability control system installed on your vehicle, please refer to additional material supplied with this operator manual, included in your glove box informational packet.

**Check Transmission**



A fault with transmission.  
(Refer to transmission manual)

**Diesel Particulate Filter (DPF) Warning Light**

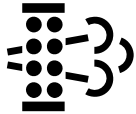

This icon and related message will appear when the DPF needs to be regenerated and then also during the regeneration cycle. This may also appear if the system is attempting to automatically regenerate while the vehicle is in Power Take Off operation mode.

Engine aftertreatment system includes a diesel particulate filter and DPF warning light.

**Differential, Inter-Axle Lock**



Illuminates when the inter-axle differential switch is ON thus locking the inter-axle differential. This powers the forward rear and the rear rear differentials equally.

When the switch is turned off (inter-axle differential unlocked) the engine power is allowed to flow to any of the four drive tires based on the differential effect (mostly to the forward rear differential). This feature is standard on all tandem axles.



**NOTE**

Tractors/Trucks and trailers built after 03/01/2001 must be able to turn on an In-Cab Trailer ABS Warning Light (per U.S. FMVSS121). The industry chose Power Line Communication (PLC) as the standard method to turn it on. On trailers built prior to 03/01/2001 verify trailer ABS system status via the required external warning light mounted on the trailer. The indicator light on the trailer should be yellow and identified with the letters ABS.

**Dump Truck, Body Up**



Illuminates when Truck Dump Body is up.

**Dump Truck, Trailer Body Up**



Illuminates when Trailer Dump body is up.

**Engine BrakeSaver or Transmission Retarder**



Illuminates when BrakeSaver (export only) or Transmission Retarder is active.

**Engine, Brake ON/OFF**



Illuminates white when the engine brake is enabled, and green when actively braking.

**Engine, Brake Level**



Indicates the level of engine braking applied when the engine brake is enabled.

**Engine, Check Engine**



Illuminates when a problem exists, but the vehicle can still be safely driven. Vehicle should be serviced to correct the problem, but the situation should not be considered an emergency.

The Check Engine lamp will activate for several reasons. These include but are not limited to Water in Fuel, No-Idle Shutdown alert screens, High Exhaust Temperature, Diesel Particulate Filter (DPF) and Diesel Exhaust Fluid (DEF) warning lights. You may need to refer to your Engine Operator's Manual for additional information.

	<b>NOTE</b>
Only for engines equipped with emissions aftertreatment.	

**Engine, Engine Block Heater**



Illuminates when the engine block heater is turned on.

**Engine, Low Coolant Level**



Illuminates with an audible alarm indicating critically low coolant level. The vehicle must be serviced to correct the problem but the situation should not be considered an emergency.

**Engine, Overspeed**



Illuminates when engine RPM is exceeded (Allison Transmissions).

**Engine, Retarder (Brake)**



Illuminates when the engine retarder (compression brake or exhaust brake) switch is turned on.

**Engine, Stop Engine**

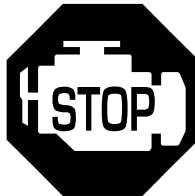

Illuminates and an audible alarm tone will sound when a major engine system problem exists.



**WARNING**

If the Stop Engine warning light illuminates, it means you have a serious engine system problem. This should be considered an emergency. You should stop the vehicle as safely as possible and turn OFF the ignition. The vehicle must be serviced and the problem corrected before driving again. Failure to comply may result in death, personal injury, equipment or property damage.

**Engine, Wait To Start**



Illuminates when engine grid heater is on. (PACCAR PX-6, PX-8, and Cummins ISL engines)

**Emissions, Engine Derate**



**Emissions, High Exhaust System Temperature**



**WARNING**

If this light is on, do not park in an area of combustible vapors or materials. You must keep combustibles at least 5 ft. (1.5 m) away from the exhaust (outlet) stream as it exits the tail pipe while the HEST light is illuminated. Always park your vehicle outside. Failure to do so could ignite an explosion or harm bystanders which could result in serious injury.



**WARNING**

If this lamp is on, do not park in an area where people are close by. You must keep combustibles at least 5 ft. (1.5 m) away from the exhaust outlet while the HEST lamp is illuminated.

Failure to do so could result in serious injury.



**WARNING**

If this lamp is on, temperature of the tailpipe, exhaust pipes, the diesel particulate filter (DPF)/selective catalytic reduction (SCR) device and surrounding components including enclosures and steps becomes elevated during engine operation or any regeneration event and can cause serious burns to the skin. Allow adequate cooling time before approaching, working on or near any part of the exhaust system or surrounding components.

Illuminates when the exhaust gas temperature and exhaust components become extremely hot.

**Fifth Wheel Locked**



Illuminates when the fifth wheel is in the locked position.

**Fifth Wheel Unlocked**



Illuminates when the fifth wheel is in the unlocked position. Indicates the king pin is disengaged.

**Fifth Wheel Slide Unlocked**



Illuminates when fifth wheel slide switch is activated. Indicates fifth wheel can move.

**! WARNING**

DO NOT move the fifth wheel while the tractor-trailer is in motion. Your load could shift suddenly, causing you to lose control of the vehicle. Never operate the vehicle with the switch in

the UNLOCK position. Always inspect the fifth wheel after you lock the switch to be sure the fifth wheel slide lock is engaged. Failure to comply may result in death, personal injury, equipment or property damage.

**i NOTE**

Vehicles having an air slide fifth wheel have a fifth wheel slider lock controlled by a switch on the instrument panel. By placing the switch in the unlock position you can slide the fifth wheel to various positions to adjust weight distribution.

**Hill Hold (Eaton Ultrashift Plus)**



Blinks when disabled by switch (once per second), or continuous with fault. The hill stop aid prevents unwanted vehicle movement on steep grades when transitioning from the brake to throttle pedal.

**Lane Departure Warning (LDW)**



Illuminates when LDW system is not able to track the vehicle's position within the lane.

**i NOTE**

For vehicles equipped with Lane Departure Warning, please refer to Lane Departure Warning Driver's Guide for additional information.

**Lights, High Beam**



Illuminates when the high beams are on. The high beam indicator will flash and a tone will sound to indicate that the head lamps are left on when: the head lamp switch is ON, the driver's door is open, AND the key switch is OFF.

### Malfunction Indicator Lamp (MIL)



Illuminates when an engine emissions failure has occurred. The vehicle can be safely driven but should be serviced to correct the problem. The situation should not be considered an emergency. In some cases, the Malfunction Indicator Lamp will activate in conjunction with the High Exhaust Temperature, Diesel Particulate Filter (DPF) and Diesel Exhaust Fluid (DEF) Warning Lights.



#### NOTE

Only for engines equipped with emissions aftertreatment.

### Message Waiting



Illuminates with telematic-equipped messaging.

### Park Brake



Illuminates when parking brakes are applied. The Park Brake lamp will flash and the warning tone will sound anytime the Park Brake is not set and the driver's door is open. Audio alarm will sound if the park brake is set and speed is greater than 5 miles per hour.

### Seat Belt, Fasten\*



Illuminates for 5 seconds whenever the ignition key is turned on, then it turns off. \*The warning lamp may also come on if the driver's seat belt is not fastened (if the vehicle was ordered with a seat belt warning light option)\*

### Transmission, Oil Temperature High



Illuminates when transmission lubricant temperature is too high.



#### CAUTION

This should be considered an emergency. You should stop the vehicle as safely as possible and turn OFF the ignition. The vehicle must be serviced and the problem corrected before driving again. Failure to do so may cause severe transmission damage.

### Turn Signal, Left



Blinks when the left turn signal or the hazard light function is operating.



### Turn Signal, Right



Blinks when the right turn signal or the hazard light function is operating.

### Worn brake



Illuminates when brake pads on optional Brake Warning System require replacement.

## Menu Control Switch

The Menu Control Switch (MCS) is a dial with buttons.

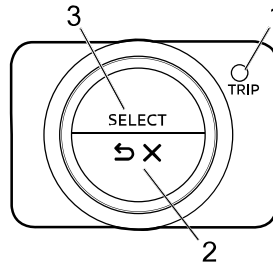

1. **Trip** – Starts a trip or sub-trip. A long press will clear all trip data.
2. **Back/Cancel** – Withdraws from changing a setting, returns to the previous menu, or suppresses a warning.
3. **Select** – Chooses menu selections, acknowledges warnings (called suppressing), and activates some drive views.

## Steering Wheel Controls (Option)



### CAUTION

Under no circumstances should you attempt to service the steering wheel, clockspring, or any of the electrical wiring in the multiplex system, or any steering components (steering column, steering driveline or steering gear). Tampering with these components may result in an inoperable multiplex system.

The steering wheel may provide controls for commonly used functions, so that their use does not require the operator to take their hands off of the steering wheel. These controls are also used to interface with the display.

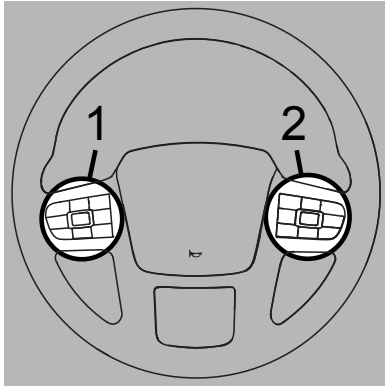

1. Left switch pod
2. Right switch pod

The switches on the left side of the horn pad, including the toggle switch, manage vehicle speed functions including cruise control and optional features such as variable road speed limiter and adaptive cruise control (see [Left Switch Pod](#)). Switches on the right side control infotainment ([Radio Stereo System](#)) and navigate and configure the digital display (see [Right Switch Pod](#) on page 64).

### Left Switch Pod

The left switch pod on the steering wheel contain buttons for the Trip and cruise control (see Cruise Control) features.

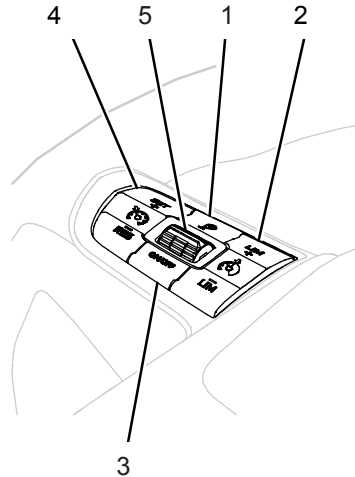

1. **Trip**
2. Variable Road Speed Limiter (VRSL) **LIM+** and **LIM-** (option)
3. Cruise Control **ON/OFF**

4. Cruise Control (CC) **SET+** and **RES-**
5. **Toggle**

### Trip

Starts a trip or sub-trip. A long press will clear all trip data.

### Right Switch Pod

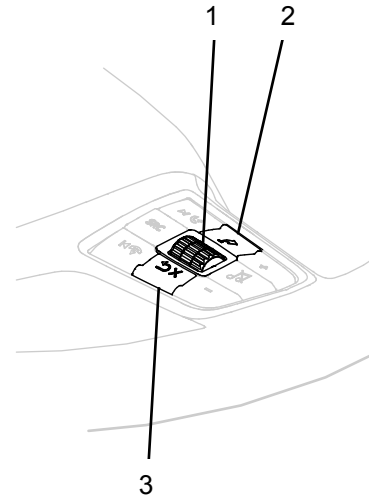

1. **Scroll**
2. Not used
3. **Back/Cancel**

The controls located on the right pod of the steering wheel are used to select the View, navigate and select items in the Menu, and view popup messages.

### Scroll Wheel

Scroll

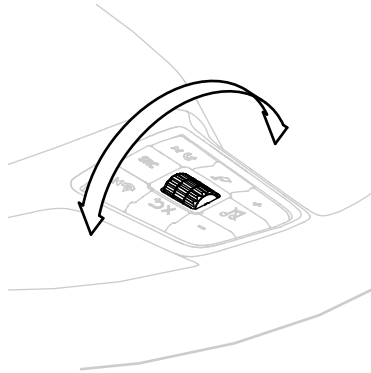

Roll (or **Scroll**) the scroll wheel to target menu selections, change settings when in the menu, and switch between Views. When the term **Scroll** is used, rolling the scroll wheel is implied.

**Select**

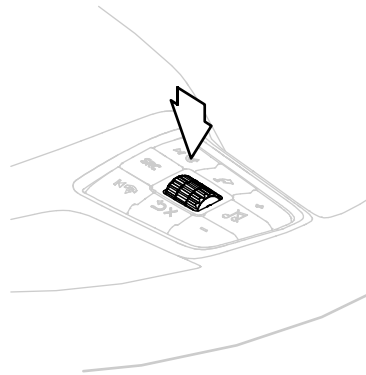

Press the scroll wheel to make a selection. When the term **Select** is used, pressing the scroll wheel is implied. **Select** to make choices in the menu; additionally, use **Select** to cycle through or suppress a

popup message (see [Popups](#) on page 69).<sup>1</sup>

The display indicates that the Scroll Wheel can be used to **Select** with this icon:

**Select**



<sup>1</sup> The parking brake must be set to access the menu.

## Exterior Lights Switch (ELS)

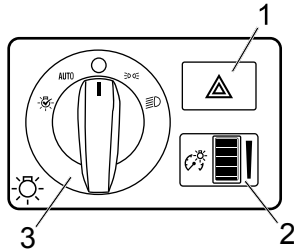

1. Hazard Lights (see [Lights, Hazard](#) on page 93)
2. Cab Dimmer (see [Cab and Panel Dimmer Switch](#) on page 89)

<sup>2</sup> Ignition switch can be in any position.

<sup>3</sup> Ignition switch can be in any position.

### 3. Exterior Lights Switch (ELS)

The **ELS** is a five-position rotary switch that controls which exterior lights are active and can also start an Exterior Lights Self Test (ELST).

#### Auto

Automatic lights turns on exterior lights based on ambient lighting and the parking brake position. During low light conditions when the

- Parking brake is released, Auto will turn on all legal driving lights (includes headlights).
- Parking brake is set, Auto this will turn on all parking lights, marker lights, license, and tail lights.

When lighting conditions brighten, Auto will turn off headlights, marker, and parking lights.

#### Off

Turns off all legal driving lights.

### Parking/Marker Lights

Turns on all legal driving lights except headlights:<sup>2</sup>

### Headlights



#### CAUTION

If you have confirmed there is a problem in the low beam wiring circuit, proceed with caution to the next available exit/turnoff and safely pull your vehicle completely off the road and call for assistance. Driving your vehicle with the headlamps on high beam (at reduced intensity) for a prolonged period may lead to an accident. Contact your nearest dealer to have the problem corrected as soon as possible.

Turns on all legal driving lights.<sup>3</sup> The left hand stalk toggles between high and low beam headlights (see High Beams).

## ELST

Momentary switch position used to start the Exterior Light Self Test (see [ELST](#)).

## Peterbilt Digital Display

The digital display will stay visible during all driving situations and in some parked situations. When the parking brake is set the following actions will wake the display, making it visible:

- Tapping the brake
- Turning the ignition switch to ON, ACC, or START
- Opening (or keeping open) the cab doors
- Starting the engine.
- Using a steering wheel button<sup>4</sup>
- Activating exterior lamps (see [Exterior Lights Switch \(ELS\)](#) on page 66)

If after 20 seconds none of these actions are taken, the display will darken to conserve power, but will awaken if any wake action is performed. If the Anti-Theft option is active and you attempt to start the

engine, a passcode prompt will appear; the engine cannot be started until the correct passcode is entered (for more information see [Anti-Theft](#) on page 68).

## Digital Display Features

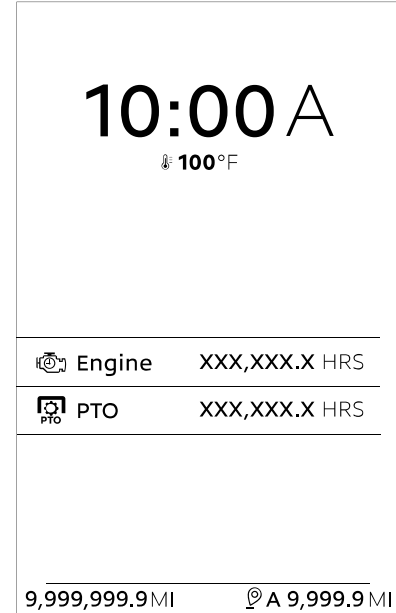

Indicating from top to bottom:

- Time
- Outside Air Temperature (OAT)

<sup>4</sup> This requires the steering wheel controls option.

- Engine Hours
- PTO Hours
- Trip (Sub-trip)
- Odometer

**Adaptive Cruise Control Notification (option)**



This indication at vehicle start means it is equipped with Adaptive Cruise Control (ACC) and Collision Mitigation. These features work together to improve driver safety and enhance the driving experience. When Cruise Control is active, ACC will accelerate and slow the truck to maintain a chosen distance from a detected forward vehicle. Collision Mitigation will attempt to prevent a forward collision when advancing at speeds greater than 15 mph (24 kph).

Please review the ACC section of this manual, and the manufacturer’s manual, prior to driving this vehicle.

**Bulb Check**

When the ignition switch is turned ON multiple warning icons will be displayed in a sequence to test each warning light indicator. The total sequence should take no more than 10 seconds to complete. Have your instrumentation system checked by a qualified service technician if does not successfully complete.

**Audible Alarm**

The audible alarm will sound in conjunction with most warning lights. These events include but are not limited to headlight on, fifth wheel, stop engine, primary/secondary air, and driver door open warnings.

**Optional Icons**

Additional icons may be operational depending on individual vehicle specifications.



**NOTE**

Some optional lights may illuminate even though your vehicle is not equipped with that particular feature.

**Anti-Theft**

Anti-Theft prevents starting the engine and accessing the settings sub-menu. If Anti-Theft does not show in the settings sub-menu, see your authorized dealer to install Anti-Theft.

If Anti-Theft is enabled, turning the ignition switch to START prompts the operator to enter the passcode. Once the correct passcode is entered, you have five minutes to start the engine or the passcode must be re-entered.<sup>5</sup>

To enable or disable Anti-Theft, change Anti-Theft (ON/OFF) in the settings sub-menu and enter the current passcode.

**How to Enter the Passcode**

The ignition key and the current passcode are required.

<sup>5</sup> The five minute timer can be postponed in one minute intervals using any steering wheel switch.

The default passcode is set to 0000 at the factory. Please see an authorized dealer if a custom passcode is needed. The operator will not need a passcode to start the engine when the anti-theft feature is turned off.

1. Using the **Scroll**, scroll to the first number in the code then press **Select**.

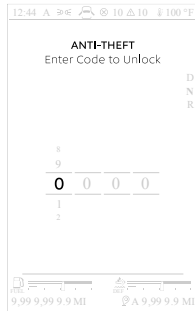

The next digit will be selected.

2. **Scroll** to the number you want for this digit and press **Select**. The next digit will be selected.
3. Continue this process until all four digits have been chosen.

The display will read "Turn Key to Start Engine."

## Display Notifications

The digital display communicates vehicle information using digital warning lights (also called Telltales), gauge states, notifications (called Popups), indicators, and audible alarms. Some conditions are communicated for informational purposes only while others may require an operator response.

### Popups

A popup communicates information. This could be due to a gauge indicating outside of its normal operating range or to notify the operator about a specific truck condition. Popups can be red, amber or white. Red and amber popups are totaled in the Active Warnings Indicator. A popup's characteristics (color, brilliance, and whether it flashes or has an audible alarm) depend on the condition which generated the popup.

When multiple popups are present, each is assigned a priority and placed in a stack. Higher priority popups are placed towards the front of the stack. The **Select** button cycles through the active popups, allowing each popup in the stack to be viewed.

Some popups, once viewed, are removed from the stack; these popups are called suppressible. Suppressible popups show an "X" below the **Select** icon and typically don't require an immediate response. Suppress these popups using the **Back/Cancel** button (or the **Select** when the parking brake is set). Non-suppressible popups cannot be removed from the stack until the parking brake is set.

### Suppressible Popup



Indicated left to right, top to bottom:

- Stack Size – The lower number indicates how many popups are in the stack (suppressible and non-suppressible), and the upper, which popup is being viewed.
- Title – Indicates affected system.
- Suppressibility – Indicates if the current popup is suppressible.<sup>6</sup>

- Instructions – Contain instructions or elaborating information.

The menu is not accessible until all popups have been suppressed.<sup>7</sup>

### Active Warnings

Red and amber popups will generate an active warning. Active warnings provide an additional reminder of the new and ongoing conditions which have generated a popup (both suppressed an unsuppressed). An active warnings count is presented in the

- Systems Check
- Notifications sub-menu
- Post-trip
- Active Warnings indicator.

The active warnings count may change without user interaction if individual warnings are intermittent, time based, self correcting, or the situation is rectified.

### Views

A view presents a specific set of gauges and/or indications on the display. The

operator can cycle through the available views using the **Scroll**. When a view is shown, its position in the view sequence is indicated on the right. Some views monitor optional systems, appearing only if those systems are installed and/or active. The menu is also positioned in the view sequence. When the parking brake is set, some views provide additional options and information. Use the **Select** to access these options. All views present the following indications:

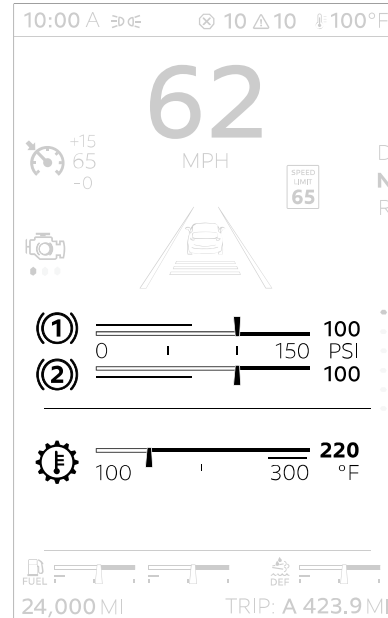

Indicating clockwise from the upper left:

- Time
- Aux Lights

<sup>6</sup> The Select icon used here is for the Menu Control Switch (MCS); vehicles with steering wheel controls indicate differently.

<sup>7</sup> All popups become suppressible when the parking brake is set.



- Active Warnings (see [Active Warnings](#)).
- Outside Air Temperature (OAT)
- Transmission Gear Display (see [Transmission Gear Display](#))
- View Indicator
- Diesel Exhaust Fluid (DEF) level.
- Trip Information (see [Trip Info](#) on page 73).
- Adaptive Cruise.
- Odometer
- Fuel Gauge
- Vehicle Speed

When the parking brake is released, the display will show useful driving information, minimizing the currently selected view and removing its label.

### Gauge Views

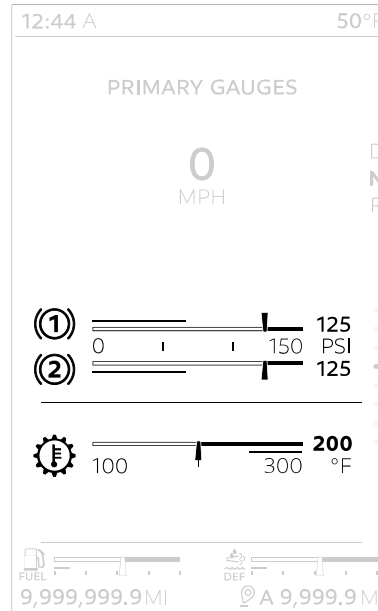

A gauge view presents the standard and optional virtual gauges monitoring your truck systems. Two single or two compound gauges can be shown per view. Gauges not shown in the first gauge view

are shown in additional gauge views until all monitored systems are represented: Primary Gauges – The highest priority gauges. For vehicles with air brakes this will include the primary and secondary air tank pressures.

Secondary Gauges – The second most important gauges.

Additional Gauges – Any additional gauges not represented by the primary and secondary gauge views.



### WARNING

DO NOT look at the Digital Display for prolonged periods while the vehicle is moving. The Digital Display should be referenced only briefly and should not be used as a substitute for observing actual road and traffic conditions. Failure to pay attention to the vehicle's road position or situation can lead to an accident and possibly result in property damage, personal injury, or death.

**Custom (option)**

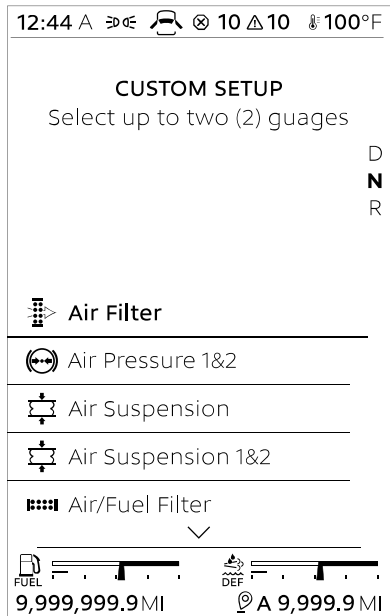

Vehicles with this option provide a view which can contain up to four operator-selected gauges. If the custom view has

not been configured, scrolling to the custom view allows the operator to enter the custom view setup (See Custom Setup).<sup>8</sup> The custom view can also be changed in the menu.

**Custom Setup**

Creates a customized view containing up to four gauges, and places that view in the view cycle. Once two single gauges or compound gauges have been selected, the remaining gauge selections will fade indicating that no further selections can be made.

1. If the custom view already contains gauges
  - Select **Clear All** to remove those gauges, or
  - Keep the current gauge or compound gauge.
2. **Scroll** to the desired gauge or compound gauge.
3. **Select** to choose that gauge. The gauge name will turn white and a check mark will appear beside the name.

	<b>NOTE</b>
<p>A gauge, once selected, can be removed by selecting that gauge again, clearing the check mark.</p>	

4. If another gauge or compound gauge is desired, repeat steps 2 and 3.
5. **Scroll to Save Configuration** and press **Select**.

The custom view will now show the selected gauges.

<sup>8</sup> To change the custom view configuration the parking brake must be set.

### Tire Pressure Monitoring System (option)

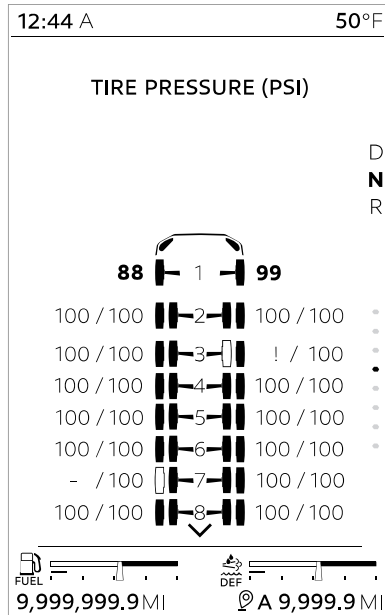

The Tire Pressure Monitoring System (TPMS) is an optional feature combining tire data with the chassis axle layout, displayed graphically. The TPMS can be

viewed only while the parking brake is set. TPMS displays individual tire pressures and tire locations, using color to indicate the tire pressure condition:

- Gray – Normal
- Amber – Low (generates a popup)
- Red – Very Low (generates a popup)
- White – High (generates a popup)

A Tire High Temperature condition will also generate a popup.

### Trip Info

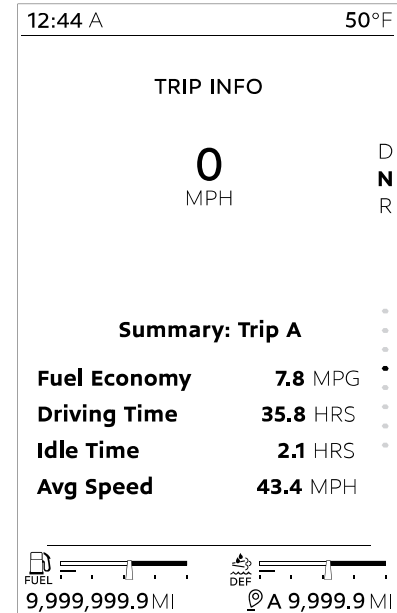

Presents information concerning truck use during the current trip. These details will be collected until the trip is reset, or the max trip distance (99,999.9 miles for main, 9,999.9 for sub-trips) is reached. For

detailed trip information see Trip Summary located in the menu.

### Adaptive Cruise (option)

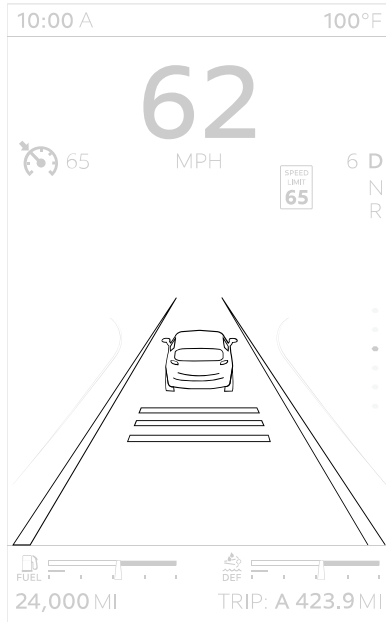

The Adaptive Cruise view contains optional features designed to improve the driving experience:

- Adaptive Cruise Control (ACC) – see [Adaptive Cruise Control](#)
- Lane Departure Warning (LDW) – see [Lane Departure Warning](#)

A minimized version of the driver assistant is presented during all views when the engine is on and the parking brake is released.

### PTO (option)

This truck may be equipped with Power Take-Off (PTO). PTO operation is enabled by using the dash mounted PTO switch in conjunction with the Cruise Control controls.

For information on PTO operation, see [PTO Operations](#).

## Menu

The menu allows the operator to view active warnings, truck performance, activate and customize vehicle features,

and access trip information. The menu can only be accessed when the parking brake is set.<sup>9</sup> Use the **Scroll** to choose the menu view and then press **Select** to access the menu. The menu contains sub-menus for

<sup>9</sup> All popups become suppressible when the parking brake is set.

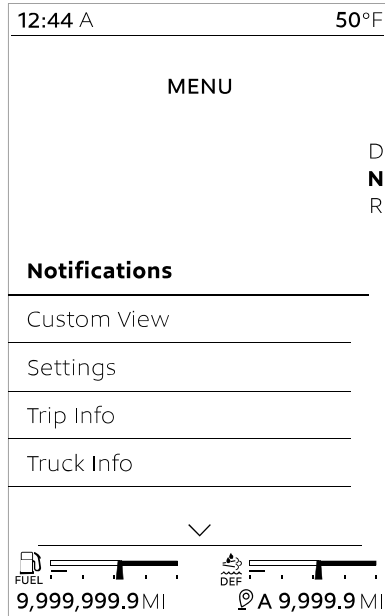

- **Notifications** – Shows active warnings and components monitored by a systems check.

- **Custom View** – Configures the custom gauge view:
  - Custom View ON/OFF – Enables the custom view.
  - Edit – Changes the gauges shown in the custom view (see [Custom Setup](#) on page 72).
  - Reset – Returns custom view to its default configuration.
- **Settings** – Customizes the display and enables functionality (see [Settings](#) on page 76).
- **Trip Info** – Shows information concerning truck use between trips (see [Trip Summary](#) on page 75).
- **Truck Info** – Truck information stores data about the vehicle (see [Truck Info](#) on page 76).

### Trip Summary

Trip Summary displays information concerning truck use between trips. This information is collected into the total trip (called the Full Trip) and optionally, several sub-trips (each identified with a letter). Trip Summary collects and totals data until the **Trip** has been reset or the max total

distance is reached, at which point no further trip information will be added. The max total distance for the main trip is 99,999.9 and 9,999.9 for a sub-trip. Each trip can be scrolled to and selected by turning the **Scroll** and then pressing **Select**.

Each trip contains the following categories:

- **Distance** – Shows the distance traveled during the sub-trip or the total distance traveled during all trips.
- **Trip Info** – Shows information about fuel use, trip time, cruise control usage, and engine load.
- **Time Stamp** – Shows the start and stop times, and the dates for the selected trip.
- **Idle** – Shows the fuel usage and time spent when idling.
- **PTO (option)** – Shows information about PTO specific usage during the trip.

The information contained in these categories can be viewed by scrolling within that specific trip sub-menu.

## Settings

Settings allows the operator to customize the display.<sup>10</sup> Selections are made by navigating to the desired setting with the **Scroll** and pressing **Select** to change the setting. Press **Back/Cancel** to return to the previous menu.

### Date & Time

- Format – Changes the clock to a 12-hour or 24-hour format.
- Automatic Time (option) – When active, automatically sets time and date based on location.
- Set Time – Sets the clock.<sup>11</sup>
- Set Date – Sets the date.<sup>12</sup>

### Units & Language

- Unit Standard/Metric – Changes the numerical readout to Standard, Metric or Metric with PSI units.
- Language – Changes the language to English, Spanish, or French.

### Features

- Anti-Theft – Turns Anti-Theft On/Off (see [Anti-Theft](#)).

- Dark Cabin – Turns Dark Cabin On/Off; this prevents cab interior lights from turning on when a cab door is opened.
- Trailer Detect – Turns Trailer Detect On/Off .
- LVD Setup – Sets the Low Voltage Disconnect setting (see [Low Voltage Disconnect](#)).

Information specific to these categories can be shown by navigating to a category using the **Scroll** and then pressing **Select**.

## Truck Info

Truck info stores specifications and data about the vehicle:

- Chassis
- Engine
- ABS
- Transmission
- Cruise Control (ACC/PCC) (option)
- GHG Vehicle Speed Limits (option)
- TPMS (option)
- PTO (option)
- Driver Assistance (LDW/LCA/LKA) (option)
- Other Software

<sup>10</sup> If Anti-Theft is enabled, settings will not be accessible until the correct passcode is entered.

<sup>11</sup> Not available if automatic time is active.

<sup>12</sup> Not available if automatic time is active.

## Post Trip

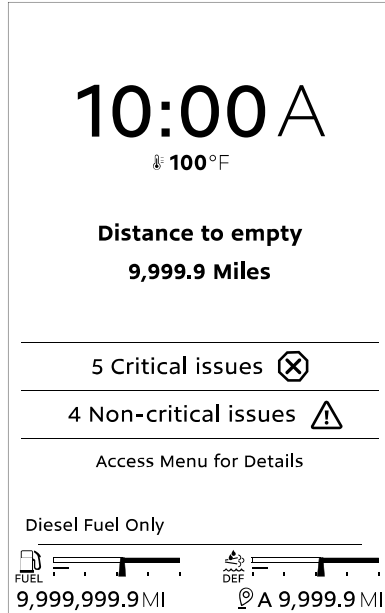







Post Trip presents information the driver might require for the next time the vehicle is operated, such as active warnings and the distance to empty. Post trip is shown when the ignition switch is turned to OFF. During Post Trip, the menu can be accessed by pressing **Select**.







## Dash Switches









This custom vehicle will have a wide variety of switch-controlled equipment. However, this particular vehicle may not have every switch identified in this section of the operator manual. Some air device switches on the dash may require that the vehicle either be at a specific speed, have park brakes set, or another device to be on or off for the air device to operate. The instrument display will show information regarding what needs to change in order for the air device to operate as expected. The following table provides a complete list of icons that may be found on the switch.







**Dash Switches**







Symbol Name	Symbol	Color	Standard	Option	Refer to
Axle, Automatic Traction Control		None	•		See <a href="#">Axle, Automatic Traction Control</a> on page 86
Axle, Diff-Lock - Dual		Amber		•	See <a href="#">Axle, Diff-Lock - Dual</a> on page 86.
Axle, Diff-Lock - Forward Rear		Amber		•	See <a href="#">Axle, Diff-Lock - Forward Rear</a> on page 87.
Axle, Diff-Lock - Front		Amber		•	See <a href="#">Axle, Diff-Lock - Steer</a> on page 87.
Axle, Diff-Lock - Rear Rear		Amber		•	See <a href="#">Axle, Diff-Lock - Rear Rear</a> on page 87.
Axle, Diff-Lock - Single Rear		Amber		•	See <a href="#">Axle, Diff-Lock - Single Rear</a> on page 87.

















Symbol Name	Symbol	Color	Standard	Option	Refer to
Axle, Inter-Axle Differential Locked (Tandem)		Amber		•	See <a href="#">Axle, Inter-Axle Differential Locked (Tandem)</a> on page 87.
Axle, Two Speed		Green		•	See <a href="#">Axle, Two Speed</a> on page 87.
Back Up Alarm Mute		Amber		•	See <a href="#">Back Up Alarm Mute</a> on page 87.
Batteries, Low Voltage Disconnect (LVD)		None	•		See <a href="#">Batteries, Low Voltage Disconnect (LVD)</a> on page 87.
Brakes, ABS Off-Road		Amber		•	See <a href="#">Brakes, ABS Off-Road</a> on page 88.
Brakes, Parking Brake Valve		Red	•		See <a href="#">Brakes, Parking Brake Valve</a> on page 88.
Brakes, Trailer Hand Brake		None		•	See <a href="#">Trailer Hand Brake</a>







Symbol Name	Symbol	Color	Standard	Option	Refer to
Cab Dimmer Switch		None	•		See <a href="#">Cab and Panel Dimmer Switch</a> on page 89
Dump Truck Gate		Red		•	See <a href="#">Dump Truck Gate</a> on page 89.
Engine, Brake Level		None		•	See <a href="#">Engine, Brake Level</a> on page 89.
Engine, Brake On/Off		Green		•	See <a href="#">Engine, Brake On/Off</a> on page 89.
Engine, Cruise Control On/Off		Green	•		See <a href="#">Engine, Cruise Control On/Off</a> on page 89.
Engine, Cruise Control Set/Resume		None	•		See <a href="#">How to Set Cruise Control Speed</a> on page 125 and <a href="#">How to Change Cruise Set Speed</a> on page 125.
Engine, Fan Override		Green		•	See <a href="#">Engine Fan Override</a> on page 89.
Engine, Heater		Green		•	See <a href="#">Engine, Heater</a> on page 90.





Symbol Name	Symbol	Color	Standard	Option	Refer to
Engine, Remote Throttle	<b>PUMP MODE</b>	Amber		•	See <a href="#">Engine, Remote Throttle</a> on page 90.
Engine, Shutdown		None		•	See <a href="#">Engine, Shutdown</a> on page 90.
Exhaust, Brake On/Off		Green		•	See <a href="#">Exhaust Brake</a> on page 145
Exhaust, Diesel Particulate Filter (DPF) Regeneration		None	•		See <a href="#">Exhaust, Diesel Particulate Filter (DPF) Regeneration</a> on page 91.
Fifth Wheel Slide		Red		•	See <a href="#">Fifth Wheel Slide</a> on page 91.
Fuel Heater		Amber		•	See <a href="#">Fuel Heater</a> on page 91.
Generic Air, Accessory		Green		•	See <a href="#">Generic Air, Accessory</a> on page 91.
Generic, Spare	<b>SPARE</b>	Green		•	See <a href="#">Generic, Spare SPARE</a> on page 91.

Symbol Name	Symbol	Color	Standard	Option	Refer to
Kingpin Release		None		•	See <a href="#">Kingpin Release</a> on page 91
Ignition Key Switch		None	•		See <a href="#">Ignition Key Switch</a> on page 103.
Lights, Beacon		Green		•	See <a href="#">Lights, Beacon</a> on page 92.
Lights, Daytime Running (Override)		Green		•	See <a href="#">Lights, Daytime Running (Override)</a> on page 92
Lights, Flood		Amber		•	See <a href="#">Lights, Flood</a> on page 92.
Lights, Flood ISO 3732 Spare		Amber		•	See <a href="#">Lights, Flood ISO 3732 Spare</a> on page 92.
Lights, Fog		Green		•	See <a href="#">Lights, Fog</a> on page 93.

Symbol Name	Symbol	Color	Standard	Option	Refer to
Lights, Footwell (option)		Green		•	See <a href="#">Lights, Footwell</a>
Lights, Hazard		Red	•		See <a href="#">Lights, Hazard</a> on page 93.
Lights, Headlight		None	•		See <a href="#">Exterior Lights Switch (ELS)</a> on page 66
Lights, Auxiliary		None	•		See <a href="#">Exterior Lights Switch (ELS)</a> on page 66
Lights, Cab/Panel Dimmer		None	•		See <a href="#">Cab and Panel Dimmer Switch</a> on page 89.
Lights, Spot		Green		•	See <a href="#">Lights, Spot</a> on page 93.
Power Take-off (PTO)		Amber		•	See <a href="#">Power Take-off (PTO)</a> on page 94.

Symbol Name	Symbol	Color	Standard	Option	Refer to
Suspension, Air Retention		Amber		•	See <a href="#">Suspension, Air Retention</a> on page 94.
Suspension, Axle, Pusher		Green		•	See <a href="#">Suspension, Axle, Pusher</a> on page 94.
Suspension, Axle, Tag		Green		•	See <a href="#">Suspension, Axle, Tag</a> on page 94.
Suspension, Lift		Amber		•	See <a href="#">Suspension, Lift</a> on page 94.
Suspension, Third Axle Lift		Green		•	See <a href="#">Suspension, Third Axle Lift</a> on page 94.
Tow Hook		Green		•	See <a href="#">Pintle Hook</a> on page 93.
Trailer Air Supply		Red		•	See <a href="#">Vehicle/Trailer Air Supply Valve</a> on page 138

Symbol Name	Symbol	Color	Standard	Option	Refer to
Trailer, Axle (3rd Axle) Lift		Green		•	See <a href="#">Trailer, Axle (3rd Axle) Lift</a> on page 95.
Trailer, Axle Lift Forward		Green		•	See <a href="#">Trailer, Axle Lift Forward</a> on page 95.
Trailer, Axle Lift Rear		Green		•	See <a href="#">Trailer, Axle Lift Rear</a> on page 95.
Trailer, Belly Dump		Red		•	See <a href="#">Trailer, Belly Dump</a> on page 95.
Trailer, Dump Gate		Red		•	See <a href="#">Trailer Dump Gate</a> on page 95
Trailer, Dump Gate Center		Red		•	See <a href="#">Trailer, Belly Dump Gate Center</a> on page 95.
Trailer, Dump Gate Front		Red		•	See <a href="#">Trailer, Belly Dump Gate Front</a> on page 95.

Symbol Name	Symbol	Color	Standard	Option	Refer to
Trailer, Dump Gate Rear		Red		•	See <a href="#">Trailer, Belly Dump Gate Rear</a> on page 95.
Trailer, Hotline		Green		•	See <a href="#">Trailer, Hotline</a> on page 95.
Trailer, Suspension Air Dump		Amber		•	See <a href="#">Trailer, Suspension Air Dump</a> on page 96.
Winch Clutch		Green		•	See <a href="#">Winch Clutch</a> on page 96.
Trip Odometer Reset Button	No Symbol	None	•		See <a href="#">Menu Control Switch</a> on page 63 or <a href="#">Left Switch Pod</a> on page 64 for steering wheel controls.

**Axle, Automatic Traction Control**



Momentarily push switch in to engage Deep Mud and Snow Traction Control. See Deep Snow and Mud Switch on page 4-34.

**Axle, Diff-Lock - Dual**



Turn switch on to engage Front and Rear Axle Diff Lock.



**Axle, Diff-Lock - Forward Rear**



Turn switch on to engage Forward Rear Axle Diff Lock.

**Axle, Diff-Lock - Steer**



Turn switch on to engage Front Axle Diff Lock.

**Axle, Diff-Lock - Rear Rear**



Turn switch on to engage Rear Rear Axle Diff Lock.

**Axle, Diff-Lock - Single Rear**



Turn switch on to engage Single Rear Axle Diff Lock.

**Axle, Inter-Axle Differential Locked (Tandem)**



Turn switch on to engage Inter-Axle Differential Lock.

**Axle, Two Speed**



If equipped, the two speed axle switch allows you to select axle high and low ranges. The low range (Off) provides maximum torque for operating off-highway.

The high range (On) is a faster ratio for highway speeds.

**Back Up Alarm Mute**



Turn switch on to mute Back Up Alarm.



NOTE

The mute function use is discouraged. Only use mute when legally required.

**Batteries, Low Voltage Disconnect (LVD)**



If your vehicle is equipped with a Low Voltage Disconnect (LVD) feature, the LVD module is located inside the driver's side kick panel.

**Purpose**

The LVD may increase battery life and prevent unnecessary jump start conditions by ensuring that an unattended load does not deplete the battery charge to a level that will prevent you from starting your vehicle.

**Operation**

The LVD will disconnect non-vital battery loads when battery voltage drops below 12.3V for 3 minutes and the key switch is in the ACC or OFF position. During the last 2 minutes the LVD will emit a slow audible beep. 30 seconds before disconnecting loads the alarm will change to a fast beep. The battery voltage must come back up above a certain voltage before the LVD will reset.

See an authorized dealer if the LVD fails to reconnect loads during normal operation.

**Circuits Disconnected by LVD**

- Cab Dome Lamps
- Cab Accessories
- Spare Battery A & B



**NOTE**

All LVD circuits are color-coded blue on the central electrical panel cover label.



**WARNING**

DO NOT use the Spare Battery A and B circuits or other circuits that are controlled by the LVD to power electronic engine controls, ABS circuits, or safety/work related lighting. Before adding any device to the vehicle's electrical system, consult your nearest authorized dealer or read the contents of TMC RP136. Failure to do so may cause equipment damage or lead to personal injury.



**NOTE**

The determination of what circuits/loads that were connected to the LVD was based upon the recommendation from Technology and Maintenance

Council (TMC) of the American Trucking Association. To review the recommended practice, see TMC RP-136.

**Brakes, ABS Off-Road**



Turn switch on to engage ABS Off-Road mode. See [Anti-Lock Brake System \(ABS\)](#) on page 55.

**Brakes, Parking Brake Valve**



Pull yellow knob to activate parking brakes.

**Brake, Trailer Hand**



This dash mounted switch provides air pressure to apply the trailer brakes only. It operates independently of the foot treadle valve.

### Cab and Panel Dimmer Switch

This switch is used to alter the brightness of the instrument panel lights and controls the cab overhead, ambient lighting.

	<p><b>NOTE</b></p>
<p>The Headlight Switch is an ON or OFF switch. The panel lights are on full intensity during the day and dim when headlights are on.</p>	

### Dump Truck Gate



Turn switch on to open Dump Truck Gate.

### Engine, Brake Level



If the engine brake is on, the up position will provide 100% engine braking, the middle position 60%, and the down

position 33% engine braking when engine braking is active.

For more information on when and how to use the engine brake in your vehicle, see the engine brake owner's manual for additional engine brake information.

### Engine, Brake On/Off



Turn switch **ON** to activate Engine Brake system. This symbol is also used for an exhaust brake. Vehicles equipped with an engine brake will not also have an exhaust brake. For more information on when and how to use the engine brake in your vehicle, see the engine brake owner's manual for additional engine brake information.

### Engine, Cruise Control On/Off



Turn switch on to activate Cruise Control System.

### Engine, Cruise Control Set/Resume



The Cruise Control Set/Resume switch allows you to **SET** the desired speed or **RESUME** the desired speed after the cruise control function has been interrupted.

### Engine Fan Override



The engine fan switch allows you to control the engine fan manually or automatically. With the ignition key switch ON and the fan switch in the **MANUAL** position, the engine fan will be on regardless of engine temperature. With the engine fan switch in the **AUTOMATIC** position, the engine fan will automatically turn on when the engine coolant reaches a temperature of about 200°F (93°C) or when the air conditioning system has reached set point pressure.

With an electronic engine, the fan may also be activated by air intake temperature, oil temperature and compression brake usage.

**! WARNING**

DO NOT work on or near the fan with the engine running. Anyone near the engine fan when it turns on could be injured. If it is set at MANUAL, the fan will turn on any time the ignition key switch is turned to the ON position. In AUTO, it could engage suddenly without warning. Before turning on the ignition or switching from AUTO to MANUAL, be sure no workers are near the fan. Failure to comply may result in death or personal injury.

**! CAUTION**

The fan or equipment near it could be damaged if the fan turns on suddenly when you do not expect it. Keep all tools and equipment away from the fan.

**! CAUTION**

DO NOT operate the engine fan in the MANUAL position for extended periods of time. The fan hub was designed for intermittent operation. Sustained operation will shorten the fan hub's service life as well as reduce fuel economy.

**Engine, Shutdown**



Momentarily push switch in to activate the shutdown system.

**Exhaust, Brake On/Off**



Turn switch **ON** to activate Exhaust Brake system. This symbol is also used for an engine brake. Vehicles equipped with an exhaust brake will not also have an engine brake. For more information on when and how to use the exhaust brake in your vehicle, see the exhaust brake owner's manual for additional exhaust brake information.

**Engine, Heater**



Turn switch on to activate the Engine Heater.

**Engine, Remote Throttle**



Turn switch on to activate Remote Throttle Control.

### Exhaust, Diesel Particulate Filter (DPF) Regeneration

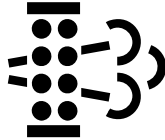

Manually controls the diesel particulate filter (DPF) regeneration process. Refer to Engine Aftertreatment Controls Operator's Manual for additional information.

### Fifth Wheel Slide



Turn switch on to unlock Fifth Wheel Slide mechanism. The switch is guarded to protect you from accidentally activating or releasing the lock.

 <b>WARNING</b>
<p>DO NOT move the fifth wheel while the tractor-trailer is in motion. Your load could shift suddenly, causing you to lose control of the vehicle. Never</p>

operate the vehicle with the switch in the UNLOCK position. Always inspect the fifth wheel after you lock the switch to be sure the fifth wheel slide lock is engaged. Failure to comply may result in death, personal injury, equipment or property damage.

 <b>NOTE</b>
<p>Vehicles having an air slide fifth wheel have a fifth wheel slider lock controlled by a switch on the instrument panel. By placing the switch in the unlock position you can slide the fifth wheel to various positions to adjust weight distribution.</p>

### Fuel Heater



Turn switch on to activate Fuel Heater.

### Generic Air, Accessory



Provides accessory air to the end of the frame connection when switch is turned on.

 <b>NOTE</b>
<p>The generic air accessory switch is designed by the original equipment manufacturer to reset when the ignition power is turned off. When ignition is turned off, this circuit will exhaust air pressure.</p>

### Generic, Spare SPARE SPARE

Turn switch on to power customer installed accessory.

### Kingpin Release



Push and hold switch to unlock the fifth wheel, releasing the kingpin. The switch is

guarded to protect you from accidentally releasing the lock. See [How to Release the Kingpin Remotely \(option\)](#) on page 157

### Lane Departure Warning Disable



Vehicles equipped with this optional switch will disable the audible and visual Lane Departure Warning for 15 minutes after which time, or upon key cycle, the feature will re-enable. The feature may also be re-enabled by toggling the switch again while disabled. The switch will not affect any of the Adaptive Cruise Control warnings.

### Ignition Key Switch



The ignition key switch located to the right of the steering column has four positions: ACC (Accessories), OFF, ON, and START. See also [Ignition Key Switch](#) on page 103.

### Lights, Beacon



Turn switch on for Beacon Light(s).

### Lights, Daytime Running (Override)



This switch overrides the normal operation of the Day Time Running Light (DRL) system. During normal operation, the DRL will turn on lights when the headlights are turned off, engine is on, and the park brakes are disengaged. The override switch will turn the DRL off in these instances. The DRL is also turned off when the headlights are turned ON.



#### WARNING

DO NOT use daytime running lights (DRL) during periods of darkness or reduced visibility. DO NOT use DRL as

a substitute for headlights or other lights during operations that require lighting of your vehicle. Failure to comply may result in personal injury, property damage or death.

If the headlight switch is turned OFF, the DRL system engages automatically after the engine starts and you release the parking brake. If the headlight switch is ON, the DRL system is overridden, and headlights operate normally. Also, the DRL is temporarily turned off during engine cranking.

### Lights, Flood



Turn switch on for cab mounted Flood Lights.

### Lights, Flood ISO 3732 Spare



Turn switch on for trailer mounted Flood Lights.

**Lights, Fog**



Turn switch on for Fog Lights.

	NOTE
<p>Across the U.S.A. and Canada, State/ Provincial requirements vary as to when high beams and fog lights can and cannot be used together. Some states allow only four lights to be used together, while some allow more. How your lights are arranged will affect whether you can operate headlights and fog lights concurrently always comply with the state or provincial requirements where you are driving.</p>	

**Lights, Footwell (option)**



Two position switch that illuminates both the driver and passenger side foot space.

**Lights, Hazard**



This button operates the hazard lights. When pressed, all four turn signals (front and rear) will continuously flash. Press the button again to turn off the hazard lights. Hazard lights work independent of the ignition switch position. You should always use the emergency hazard lights if the vehicle is disabled or parked under emergency conditions.

	<b>WARNING</b>
<p>Use your Hazard Warning Light System any time you have to stop off the road or on the side of the road, day or</p>	

night. A hard-to-see vehicle can result in an injury or accident. Another vehicle could run into you if you do not set your flashers and follow the placement of emergency signals per FMCSR 392.22.

**Lights, Spot**



Turn switch on for Spot Light.

**Pintle Hook**



Turn switch on to remove the slack from the Tow Hook.

**Power Take-off (PTO)**



This vehicle may be equipped with a dash mounted switch that controls PTO engagement/disengagement. When the operator activates the switch for the PTO, the status indicator light (located on the switch) will immediately illuminate even though PTO engagement may not have occurred. If the PTO is engaged and the operator turns the switch OFF, the PTO status indicator light (located on the switch) will go out immediately even though PTO disengagement may not have occurred.

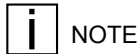

Actual PTO engagement/disengagement may be delayed momentarily since it is controlled by the air system and mechanical movement.

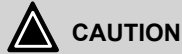

**CAUTION**

Increasing engine rpm before the PTO is actually engaged could prevent the PTO from engaging and/or cause PTO damage.

**Suspension, Air Retention**

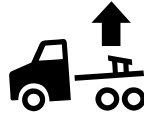

The Air Retention Switch keeps the air suspension bags from losing air pressure when used with vehicle outriggers. Depress the Air Retention Switch prior to deploying the outriggers. While outriggers are deployed axle stability is maintained.

**Suspension, Axle, Pusher**

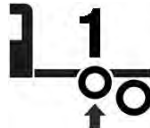

Turn switch on to lower Single or Forward Pusher Axle.

**Suspension, Axle, Tag**



Turn switch on to lower tag axle.

**Suspension, Lift**



Turn switch on to over-inflate suspension air bags. Turn switch off for normal suspension height.

**Suspension, Third Axle Lift**



Turn switch on to raise Third Axle.



**Trailer Air Supply**



The red octagonal knob controls the air supply to the trailer.

**Trailer, Axle (3rd Axle) Lift**

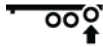

Turn switch ON to lift 3rd Trailer Axle.

**Trailer, Axle Lift Forward**

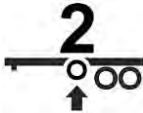

Turn switch on to lift Forward Trailer Axle.

**Trailer, Axle Lift Rear**

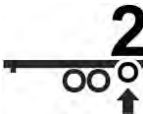

Turn switch on to lift Rear Trailer Axle.

**Trailer, Belly Dump**



Turn switch on to open Trailer Belly Dump.

**Trailer Dump Gate**



Turn switch on to open Trailer Dump Gate.

**Trailer, Belly Dump Gate Center**



Turn switch on to open Trailer Center Belly Dump Gate.

**Trailer, Belly Dump Gate Front**



Turn switch on to open Trailer Front Belly Dump Gate.

**Trailer, Belly Dump Gate Rear**



Turn switch on to open Trailer Rear Belly Dump Gate.

**Trailer, Hotline**



Turn switch on to supply electrical power to trailer accessories.

3

### Trailer, Suspension Air Dump

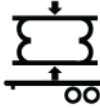

Turn switch on to deflate trailer air suspension.

### Winch Clutch



Turn switch on to engage winch clutch.

## Steering Column Controls

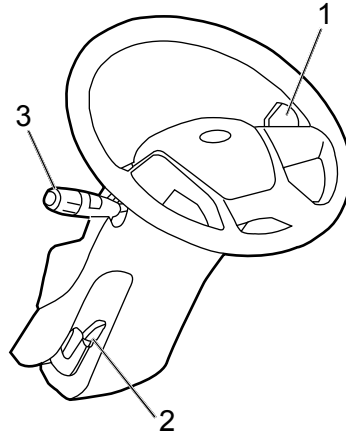

1. Gear shift stalk (option)
2. Tilt/telescope lever
3. Turn signal/wiper/lights

The turn signal lever is mounted on the left side of the steering column. The lever controls several functions: turn signal, high beam, and windshield wiper control. The turn signal lever will only operate when the key is in the ignition in the ACC position.

### Tilt/Telescoping Steering Wheel

Depending on your vehicle's configuration, you may have either a tilt/telescoping feature.

- The tilt feature allows forward and rearward movement of the wheel.
- The telescoping feature allows you to move the wheel up and down.



#### WARNING

Make all adjustments to the steering mechanism while the vehicle is stopped. Adjusting the Tilt Telescoping Steering Wheel while the vehicle is in motion could cause loss of control. You would not be able to steer properly and could have an accident resulting in death or personal injury.

### Stop/Turn Signal Lamp Operation

Your vehicle uses combined stop/turn signal lamps at the rear of the vehicle, using the same bulb to perform both functions. This means a single bulb is used for the brake lamp as well as the turn signal lamp. This bulb will burn steadily with the brakes applied. The same bulb will

flash with the turn signal activated, even with the brakes applied.

### How to Use the Turn Signal

The lever-action turn signal/high beam switch is located on the left side of the steering column. The ignition key must be turned to ON for the signal/switch to operate.



#### NOTE

If the vehicle turn signals and turn signal indicators in the dash gauge cluster ever begin flashing at an accelerated rate (115 cycles per minute) when the turn signal lever is in the OFF (center) position, or when a Right/Left turn has been selected, the problem may be related to a failed turn signal switch or turn signal module. In either case, the problem is not a failed bulb. Contact your nearest authorized dealer to have the problem corrected as soon as possible.

1. Push the **Signal stalk** lever up to engage the RIGHT turn signal and down to engage the LEFT turn signal.



2. Release the signal stalk.
3. The turn signal will cancel when the turn is complete.

An audible beep is associated with each time a turn indicator is activated.



#### WARNING

After you complete a turn, shut the system off by returning the lever to the "OFF" (center) position. Failure to shut off a turn signal could confuse other drivers and result in an accident. An indicator lamp in the instrument panel will flash until the turn signal is turned off.

### High Beam



#### NOTE

The headlights must be ON for the high beam switch to operate.

- To switch your headlights to lower or higher beam, gently pull the turn signal lever, toward the steering wheel, until you hear the switch click and the beam changes. The blue indicator light in the instrument panel will be ON when the high beam is being used.
- To return to previous beam: pull the lever towards the steering wheel again.
- To momentarily flash your headlights (illuminating the high-beams), push the turn signal lever forward.

**i** NOTE

- You cannot momentarily flash headlights when high beams are on. The headlights will flash on if they are off, if headlamps are on as low beams, headlamps dim to 25%.
- Headlight flash is not available on models with high intensity discharge (HID) headlight option.
- Check your local state's regulations for any restriction on the use of the high-beam flashing function.

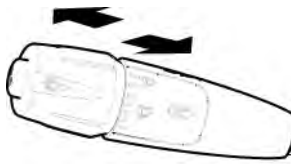

2. The lever will automatically return when the lever is released.

The blue indicator light in the instrument panel will momentarily turn ON and the high beams will flash. The high beams will not remain on if the lever is still pressed.

**i** NOTE

Continued pressing of the high beam flash will not keep the high beams on.

**⚠** WARNING

Clean blades regularly with a damp cloth to remove road film and wax buildup. DO NOT drive with worn or dirty wiper blades. They can reduce visibility, making driving hazardous which may lead to an accident resulting in death or personal injury.

**⚠** CAUTION

DO NOT use antifreeze or engine coolant in the windshield washer reservoir, damage to seals and other components will result.

### How to Momentarily Flash High Beams

The "flash to pass" high beam function is operated by the same steering column lever for the turn signals. The high beam flash to pass will work if the headlights are not on.

1. Gently push the turn signal lever, away from the steering wheel.

### Operate the Windshield Wipers

This vehicle is equipped with a two speed, intermittent windshield wiper system. The windshield wiper system is integrated with the exterior lights so that the low beam headlights will turn on when the windshield wipers turn on.

To override this function, turn the headlights on and then off again. Permanently overriding this functionality is attainable via the Settings Menu in the instrument cluster display. Go to **Settings > Wiper Interlock** and turn this value to OFF.

Avoid running the wiper blades over a dry windshield to prevent scratching the glass. Spray on washer fluid first. A scratched windshield will reduce visibility.

A seven-position rotary wiper switch (located on the turn signal lever) operates the windshield wipers and washer. If you need to use the windshield wipers:

1. Rotate the end of the turn signal lever to change the wiper mode from off to on.
2. Rotate the outer knob of the turn stalk lever to adjust the wiper speed.

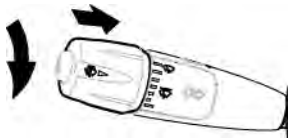

- Four levels of intermittent speeds
- Low wiper speed
- High wiper speed

### How to Spray Windshield Washer Fluid

This vehicle is equipped with a function to wash the windshield and simultaneously engage the wipers.

**CAUTION**

If the electric pump is operated for a long period (more than 15 seconds) with a dry reservoir, the pump motor may be damaged.

If you need to use the windshield washer:

1. Push the **Turn Signal Lever Outer Knob** in.



- Press and hold will activate the washer fluid and wipers.
- Instant press and release will activate the washer fluid only.

- Transmission Mode selection (**D - N - R** or **D - N - R - P**)
- Manual and Automatic Mode selection
- Upshifting and Downshifting (includes **Low Mode**)

### Transmission Mode

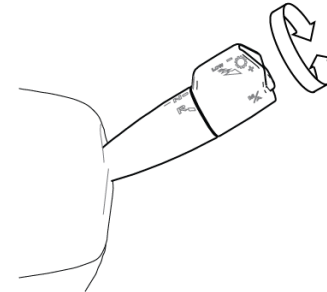

### Gear Shift Lever (option)

This vehicle may be equipped with a gear shifter located on the right-hand side of the steering column. The Gear Shift Lever can perform the following transmission functions:

The transmission mode is selected by rotating the lever outer knob. There is a position for Drive (**D**), Neutral (**N**), and Reverse (**R**) and for some vehicles Park (**P**).

Rotating the knob to the Park (**P**) or Reverse (**R**) position while the vehicle is

moving forward, or to the Park (P) or Drive (D) position while the vehicle is moving backward, will not change the transmission mode to those selections.

The Digital Display will indicate the corresponding mode.



### NOTE

Vehicles without a Park (P) mode must be in Neutral (N) to start the truck.

### Manual and Automatic Mode

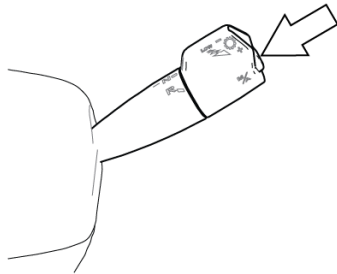

This button will put the transmission into manual mode. Manual mode will allow the

operator to select the gear (See Upshifting and Downshifting).

To activate, put the gear selector in the D (drive) mode and then depress the M/A button. When Manual Mode is selected, a M is shown in the Transmission Gear Display ([Transmission Gear Display](#) on page 129).

### Upshifting and Downshifting

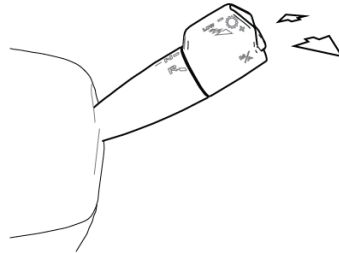

Manually upshifting and downshifting selects the transmission gear in order to accommodate the driving needs of the operator. The Transmission Mode must be in Drive (D) for the transmission to

acknowledge an upshift or downshifting request from the Gear Shift Lever.

When in Manual mode, the transmission gears can be manually selected by pushing or pulling on the lever. Pulling the lever towards the driver will upshift the transmission (+). Pushing the lever forward will downshift (-). Pushing and holding the lever forward will engage the LOW gear range.

When in Automatic mode, pushing or pulling the lever will briefly upshift or downshift the transmission gear respectively (about four seconds); after which, the transmission will return to the ideal gearing for the current vehicle speed and engine use.

The selected gear will appear beside the transmission mode on Transmission Gear Display ([Transmission Gear Display](#) on page 129).

### City Horn

Depressing the horn pad in the center of the steering wheel activates the electric horn. Look for this symbol on the center pad of the steering wheel.

To use the electric horn, press the button in the center of the steering wheel, which is the standard location for electric horns.

Your vehicle may be equipped with

optional air horns. To operate, pull on the lanyard extending from the overhead header panel.

### Door Mounted Mirror Controls

If your vehicle is equipped with power mirrors, the mirror controls will be located on the driver-side door pad. Mirrors can be adjusted in four directions. To provide good visibility, adjust the mirror so the side of your vehicle appears in the inboard part of the mirror.

	<b>NOTE</b>
If your vehicle is equipped with digital side-view mirrors (option) refer to the PACCAR Digital Vision System with Mirrors operator's manual.	

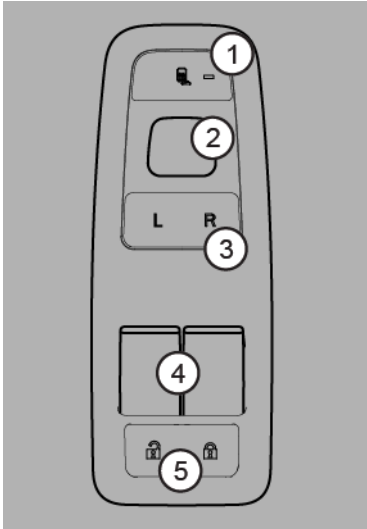

1. Mirror heat
2. Mirror adjust
3. Left or right mirror adjust selector
4. Window controls
5. Door lock control

#### Mirror Heat Switch

Your vehicle may be equipped with optional heated mirrors. Mirror heat is

controlled by the mirror heat switch button. If the vehicle has optional hood-mounted heated mirrors, this switch will also activate heat to those mirrors. If the vehicles has optional LED headlights, this switch will also activate heat to those headlights.

#### Power Mirror Switch

If your vehicle is equipped with power mirrors, the directional controls for both mirrors are located near the top of the driver-side door trim pad.

#### Power Door Lock Switch

Power door lock rocker switches are located on the door pads. To lock or unlock both cab doors as well as a sleeper door, depress any door lock switch at the end that displays a closed or open padlock symbol, respectively, on the switch face.

#### Power Window Switch

Power window rocker switches are located on the door pads. Depress the switch to open the window or pull up on the switch to close the window. Release the switch to stop window movement. The driver-side window has an express down feature. Pushing on the switch all the way down until the switch bumps will activate the express down feature. Release the button

and the window will continue to open until it is completely open.

### Introduction

Your vehicle comes equipped with two outside rear view mirrors that enable you to see to the sides and behind your vehicle. Be sure both mirrors are adjusted properly before you begin driving.



#### WARNING

Adjusting the mirrors while driving may cause you to take your eyes off the road, which could result in an accident. Adjust all mirrors before driving. Failure to do so could lead to serious injury or property damage.

To provide good visibility, adjust the mirror so the side of your vehicle appears in the inboard part of the mirror.



#### WARNING

Convex mirrors can distort images and make objects appear smaller and farther away than they really are. You

could have an accident if you are too close to another vehicle or other object. Keep plenty of space between your vehicle and others when you turn or change lanes. Remember that other objects are closer than they may appear.

### How to Use Power Mirror Adjustment Switches



#### WARNING

Adjusting the mirrors while driving may cause you to take your eyes off the road, which could result in an accident. Adjust all mirrors before driving. Failure to do so could lead to serious injury or property damage.



#### WARNING

Convex mirrors can distort images and make objects appear smaller and farther away than they really are. You could have an accident if you are too

close to another vehicle or other object. Keep plenty of space between your vehicle and others when you turn or change lanes. Remember that other objects are closer than they may appear.

1. Move the **Mirror Selector** switch (3) to the right or left from the neutral center position to select the desired mirror for adjustment.
2. Depress the **Mirror Directional Control** pad (2) in one of its four arrow directions to adjust the mirror in/out or up/down.
3. To provide good visibility, adjust the mirror so the side of your vehicle appears in the inboard part of the mirror.
4. After mirror adjustments have been completed, return the **Mirror Selector** switch back (3) to the center (neutral) position to prevent unintentional adjustments to the mirrors.



## Ignition Key Switch

The ignition key switch located to the right of the steering column has four positions: ACC (Accessories), OFF, ON, and START.



**OFF:** In this position all accessories are OFF (except those listed below) and you can remove the key.

The following lights and accessories have power when the key is in the OFF position:

- brake lights
- emergency hazard flasher
- dome and courtesy lamps (on doors)
- electric horn
- cigarette lighter
- tail lights

- marker lamps
- headlights
- radio station memory
- instrument lights
- auxiliary power
- instrument panel memory settings

**ACC (Accessory):** With the key in this position you can play the radio, defrost mirrors (if equipped with mirror heat) or use other accessories.

**ON:** In the ON position all circuits are energized. Panel warning lights will light and the buzzer will sound until (1) the engine is started, (2) normal oil operating pressure is reached, and (3) air brake system pressure is above 65 psi (441 kPa). In this position, the ignition key cannot be removed.

**START:** Turn the key to this position to start your engine. Release the key after the engine has started.

## Exterior Lighting Self-Test (ELST)

The Exterior Lighting Self-Test (ELST) allows the operator to examine all exterior

lights as part of a pre-trip inspection. An ELST can be activated via the dash switch or the key fob. A full ELST can only be activated with the ignition switch in the ON position; otherwise, a limited ELST is performed.

The ELST will run for fifteen minutes. Exterior light functionality can be verified by watching the lights from outside the vehicle and by reading the instrument cluster for displayed faults. The operator may interrupt the test by turning the vehicle off or activating the switch a second time while the test is running. The ELST will also start the system check ([Systems Check](#) on page 26).

### Full ELST

When a full ELST is activated, it will alternately turn on and then off the following lights:

- Park lights
- License plate lights
- Hazard/turn signals
- Low beam headlights
- High beam headlights
- First set of fog/driving lights
- Tail lights
- Stop lights
- Reverse lights

- Fog lights (option)
- Driving lights (option)
- Daytime Running Lights (option)

The following lights stay on during the duration of a full test:

- Clearance lights
- Identification lights
- Side Marker lights
- Beacon/Strobe (option)
- Work/Load lights (option)
- Sign light (option)

### Limited ELST

A limited ELST will alternately turn on and then off the following lights:

- Hazard/turn signals
- Low beam headlights
- High beam headlights
- Park lights
- Daytime running lights (option)
- License plate lights
- Tail lights
- Stop lights

The following lights will stay on during the duration of a limited test:

- Clearance lights
- Identification lights
- Side marker lights

### Test the Exterior Lights

For a full ELST, the parking brake must be set and the ignition switch must be in the ON position. For a limited ELST, the ignition switch must be in the ACC or OFF position.

A full ELST will test all exterior lights (also checking the mirror and headlight heaters if the engine is on). A limited ELST will test only the legal driving lights.

1. Turn the **Exterior Lighting Switch (ELS)** to the momentary ELST position and release the switch, or



The ELST icon will illuminate.

2. Press the **ELST button** on the key fob.

A full ELST will continue until the parking brake is released or the ignition switch is turned to OFF. Both the full and limited ELST will stop if either the dash or key fob ELST buttons are pressed, or the fifteen minute test duration has elapsed.

## Heating and Air Conditioning

This vehicle's heating and air conditioning system operates in four distinct modes: manual, automatic, semi-automatic, and maximum defrost. Each mode provides the driver with the greatest level of comfort and convenience.

The recommended mode for all conditions that do not require windshield defrosting is the automatic mode. This mode is capable of maintaining cab comfort under various driving conditions without driver interaction. The cab heater and air conditioner controls are located together in the center of the dash just to the right of the steering column. The sleeper heater and air conditioner controls are located in the sleeper cabinet.

**WARNING**

DO NOT drive with visibility reduced by fog, condensation, or frost on the windshield. Your view may be obscured, which may result in death, personal injury, equipment or property damage. For clear visibility and safe driving it is extremely important for you to follow the instructions pertaining to the function and use of the ventilation/heating and defogging/defrosting system. If in doubt, consult your dealer. Maximum heating output and fast defrosting can be obtained only after the engine has reached operating temperature.

**WARNING**

Exhaust fumes from the engine contain carbon monoxide, a colorless and odorless gas. DO NOT breathe the engine exhaust gas. A poorly maintained, damaged or corroded exhaust system can allow carbon monoxide to enter the cab. Entry of carbon monoxide into the cab is also possible from other ve-

hicles nearby. Failure to properly maintain your vehicle could cause carbon monoxide to enter the cab, resulting in death or personal injury.

**WARNING**

Never idle your vehicle for prolonged periods of time if you sense that exhaust fumes are entering the cab. Investigate the cause of the fumes and correct it as soon as possible. If the vehicle must be driven under these conditions, drive only with the windows open. Failure to repair the source of the exhaust fumes may result in death, personal injury, equipment or property damage.

**CAUTION**

Do not stay in the vehicle with the engine running or idling for more than 10 minutes with the vehicle's Heater and A/C ventilation system in RECIRC or at LOW FAN SPEED. Even with the ventilation system on, running the engine while parked or stopped for pro-

longed periods of time is not recommended.

**NOTE**

Keep the engine exhaust system and the vehicle's cab ventilation system properly maintained. It is recommended that the vehicle's exhaust system and cab be inspected (1) By a competent technician every 15,000 miles (24,000 km) (2) Whenever a change is noticed in the sound of the exhaust system (3) Whenever the exhaust system, underbody, or cab is damaged.

**NOTE**

If you are required to idle your vehicle for long periods of time, install an auxiliary heater or automatic idle control. These auxiliary devices can reduce fuel consumption and save you money.



**NOTE**

If you are parked next to idling vehicles, move your vehicle or do not stay in your vehicle for prolonged periods of time.

**Air Conditioner Controls**

3

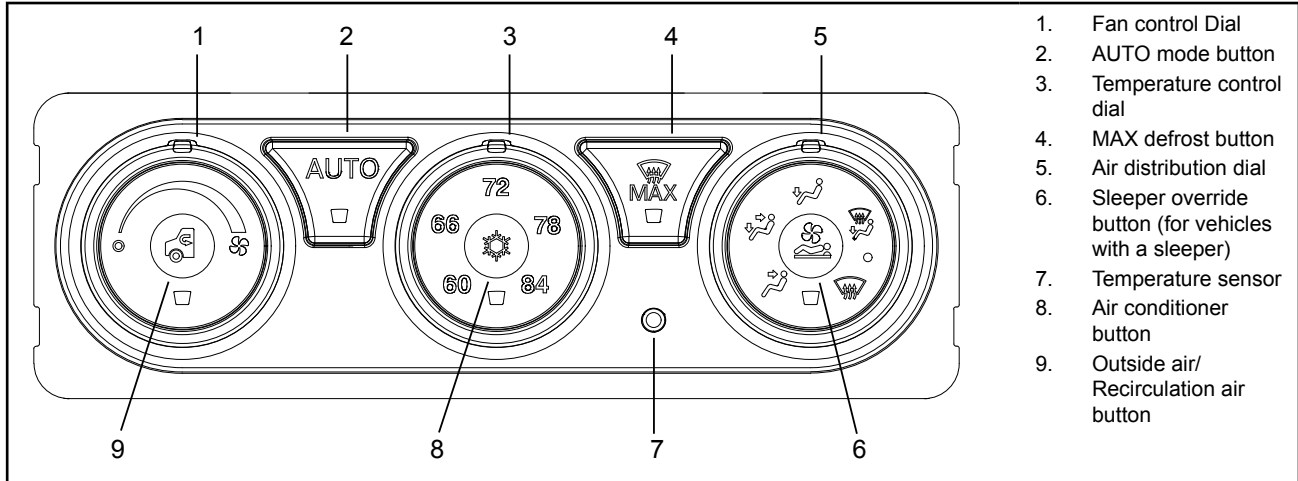

1. Fan control Dial
2. AUTO mode button
3. Temperature control dial
4. MAX defrost button
5. Air distribution dial
6. Sleeper override button (for vehicles with a sleeper)
7. Temperature sensor
8. Air conditioner button
9. Outside air/ Recirculation air button

### Air Conditioning Functions

Short Description: These symbols for the air conditioner operate various system functions.

### Symbols for the air conditioning control panel



Image	Function
	The source of air entering the cab can be set to either outside air or recirculation air using the button inside the fan speed control dial. Recirculated air is automatically selected in defrost modes.
	The fan speed is adjusted by rotating the dial clockwise to increase speed or counterclockwise to decrease speed.
<b>AUTO</b>	Automatic air conditioner function









Image	Function
	The button inside the temperature control dial engages the A/C compressor. When activated the indicator on the button will illuminate. During AUTO mode, the A/C button indicator will remain illuminated at all times even though the compressor may be cycling.
	Max defrost function
	Power to the sleeper HVAC unit can be toggled using the button inside the air distribution dial. When activated, the indicator on the button illuminates. The sleeper HVAC unit will function to the settings of the sleeper control.
	Floor Vents

Image	Function
	Defrost Vents (and Fresh air intake)
	Panel and Floor Vents
	Panel Vents
	Floor and Defrost Vents (and Fresh air intake)

### How to Manually Control the Cab Air Conditioner

**Temperature Control Set Point** The cab temperature is set using the temperature control dial. The operating range is 60°F (16°C) and 84°F (28°C). Adjustments are made in two degree increments.

**Air Conditioner** The button inside the temperature control dial engages the A/C compressor. When activated the indicator on the button will illuminate. During AUTO mode, the A/C button indicator will remain illuminated at all times even though the compressor may be cycling.



**NOTE**

Fan Control Dial must also be in the ON position for A/C to be on. A/C engages automatically in AUTO, defrost, and floor/defrost.

3

The air conditioner defaults to Manual mode when turned on. The fan speed, air temperature, and air outlets are selected using the dials on the controller.

1. To adjust the fan speed, turn the **Fan Control** dial clockwise to increase speed or counterclockwise to decrease speed.
2. To adjust the temperature setting, turn the **Temperature Control** dial to the desired temperature. The system automatically adjusts the outlet air temperature to achieve the desired cab temperature.
3. Push the **Air Conditioner** button if the air temperature needs to be colder, this button will manually turn on the compressor



4. To adjust the air distribution, turn the **Air Distribution** dial to distribute cab air as indicated by the dial graphics.
5. Press the **Recirculation** button to use cab air instead of outside air.



The temperature of the air from the vents will fluctuate as the vehicle works to achieve the chosen cab temperature. When idling for short periods of time, keep the fan ON and turn OFF **recirculation**. For vehicles with a sleeper, the cab control can be used to activate/deactivate the sleeper HVAC using the button inside the mode dial.

**Auto Mode for the Air Conditioner**

The Auto Mode will manipulate the air distribution, air temperature, fan speed, A/C compressor, and cab air recirculation to achieve the comfort level selected on the temperature dial. Depending on the specific environmental conditions, the air temperature can be slightly higher or lower than the set point. This is a normal function of the AUTO mode and is not to be mistaken for a malfunctioning system. The

button that enables automatic mode is labeled **AUTO**.

**AUTO**

The system will remain in automatic mode until the driver adjusts the dials on the control. Adjust the temperature knob and the system will respond to obtain the selected comfort level as quickly as possible.

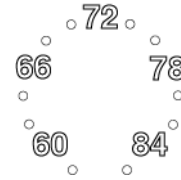

The cab temperature is set using the temperature control dial. The operating range is 60°F (16°C) and 84°F (28°C). Adjustments are made in two degree increments.

The AUTO function uses a sun light sensor to measure the amount of sunlight entering the cab. This sensor is located at the base of the windshield on the driver's side of the instrument panel. Do not block this sensor.

**Semi-automatic Mode**

During AUTO mode, the operator may override any setting and operate in a semi-

automatic mode. This can be done via the dials and/or buttons on the HVAC control. In Semi-automatic mode, the AUTO button indicator will cease to be illuminated. Instead, the indicator of the adjusted setting will illuminate. For example, if the driver adjusts the fan dial while in AUTO mode, the fan dial indicator will illuminate and fan speed will adjust to the setting of the dial. However, the temperature and air outlet settings will continue to function automatically. Similarly, if user adjusts the air distribution setting while in AUTO mode, the air distribution dial indicator will illuminate and the distribution will adjust to the setting of the dial. The fan and temperature settings will continue to function automatically.

### Economy Function

An economy function is also available in Semi-automatic mode. In this mode, the system will operate in AUTO mode without the use of the A/C compressor. The operator may select economy by initiating AUTO mode and then pressing the A/C button to disengage the compressor. The indicators for A/C compressor and AUTO mode do not illuminate while operating in economy mode.

### How to Operate Automatic Cab Air Conditioner

Follow these steps to activate the Auto Mode:

1. Press the **AUTO** button.
2. Rotate the **Temperature Control** dial to the desired temperature.

The system will achieve the comfort level associated with the temperature selected. Cab temperature can be slightly higher or lower than the selected temperature, which is a normal when in **AUTO** mode and should not be mistaken for a system malfunction.

### MAX Defrost Mode

The heating and air conditioning system provides for one touch windshield defrosting. Certain driving conditions will cause fog or ice to form on the windshield. By pressing the **MAX** defrost button, the system will automatically adjust the blower speed, recirculation, air temperature, and air outlet distribution to maximize clearing of the windshield. The system will remain in this mode until the driver presses the button again or adjusts the dials.



The air temperature in MAX defrost mode will be set to the warmest temperature setting. This setting helps to clear the windshield of ice and fog more quickly. Outside air mode and the air conditioner compressor are also active to maximize performance. The A/C compressor and recirculation switches are disabled in MAX Defrost.

### Air Conditioner Operating Tips



#### CAUTION

During extreme cold weather, DO NOT blow hot defroster air onto cold windshields. This could crack the glass. Turn the Air Flow Control Dial to Defrost and adjust the fan speed accordingly while the engine warms. If the engine is already warm, move the Temperature Control Dial to "cool," then gradually increase the temperature when you see that the windshield is starting to warm up. Failure to comply may result in equipment damage.

### Defrosting and Defogging the Windshield

The cab windshield and side windows can be cleared of ice and fog in two ways. The first is to use the **MAX** defrost mode. The second is to manually adjust the air distribution dial to the defrost position. The manual defrost/defogging mode differs from the **MAX** defrost mode by allowing the driver to select an air temperature other than full heat. This allows the driver to maintain a constant cab temperature while

defrosting the windshield. However, note that performance may be reduced.

- Adjust the fan speed to high by rotating the fan control dial clockwise.
- Set the air distribution dial to the defrost mode setting. This automatically engages the outside air and the air conditioner compressor.
- Adjust the temperature dial to add heat as needed.

For maximum performance, adjust the temperature to maximum heat by rotating the temperature dial clockwise. The driver may also use the floor/defrost setting on the air control

### For Maximum Cooling

- Adjust the fan speed to high by rotating the fan control dial clockwise.
- Set the air distribution dial to the panel setting.
- Adjust the air temperature to maximum cool by rotating the temperature dial counterclockwise.
- Engage the air conditioner compressor by pressing the air conditioner button.

- Set the air source to recirculation mode by pressing the outside air/recirculation air button. The button indicator light should be illuminated.

### For Maximum Heating

- Adjust the fan speed to high by rotating the fan control dial clockwise.
- Set the air distribution dial to the floor setting.
- Adjust the air temperature to maximum heat by rotating the temperature dial clockwise.



#### NOTE

The engine must be at operating temperature for maximum heating. If operating in AUTO mode, heating airflow is not allowed until the engine warms sufficiently to provide required coolant temperatures.

### Air Dehumidification

The air conditioner system can be used to reduce the humidity level of the cab and clear fog from the windshield.



- Adjust fan speed to the desired airflow setting.
- Engage the air conditioner compressor by pressing the air conditioner button.
- Set the air source to outside air mode by pressing the outside air/recirculation air button. The button indicator light should NOT be illuminated.

**NOTE**

The A/C compressor may not engage when the outside temperature is below 34°F (1°C).

**Cab Air Distribution**

Equal distribution of air is important in maintaining a constant cab interior temperature. For best performance, all vents should remain open to allow AUTO mode to function properly. To maintain the selected cab temperature, AUTO mode may provide an air temperature from the vents that differs from the temperature set point. To ensure proper operation, it is recommended that the driver redirects the air instead of adjusting the temperature set point or closing the vent. The system may

have difficulties in obtaining the desired cabin temperature if the temperature setting is repeatedly changed. The mode of air distribution inside the cab is set using the air distribution dial. Five icons on the dial indicate the primary mode options. The driver may also select a secondary mode in between the primary modes indicated by points on the dial. Airflow is provided to the side windows in all modes.

**Outside Air/Recirculation Air**

Selecting air recirculation mode completely isolates the cab interior from the outside air. This mode is helpful in preventing dust, pollen, and odors from entering the cab. Additionally, recirculation mode can reduce the amount of time needed to cool down the vehicle while in maximum cool down. Note that the mode may increase fogging on the windshield. A coarse air filter is provided for recirculation air and is located under the IP. The outside air mode provides for 100% outside air into the cab. This mode is helpful with windshield defogging. A pleated air filter located under hood provides filtration for dust, pollen, and debris. If equipped, your vehicle may also provide for ember filtration or fine particulate filtration.

**Cab Accessories****NOTE**

The 12V accessory power port will operate with the ignition key in either the OFF, ACC (accessory), or ON position.

This vehicle comes standard with two cupholders and power ports located in the center of the dashboard. This vehicle may contain a variety of optional cab accessories. Electrically powered cab accessories, such as the stereo system, can be used when the ignition switch is in the ACC position and can be affected by the Low Voltage Disconnect (see Low Voltage Disconnect).

**Radio Stereo System (option)**

Your vehicle has one of two stereo systems. An AM/FM stereo receiver is standard equipment and may have a combination of CD, satellite radio, USB media, or Bluetooth. A stereo system integrated with GPS navigation and telematics is also available (option). For instructions on how to operate your

particular radio, see the supplemental operating manual for those units. Controls for the infotainment system are located on the Right Switch Pod of the steering wheel.

**Right Switch Pod (Infotainment)**

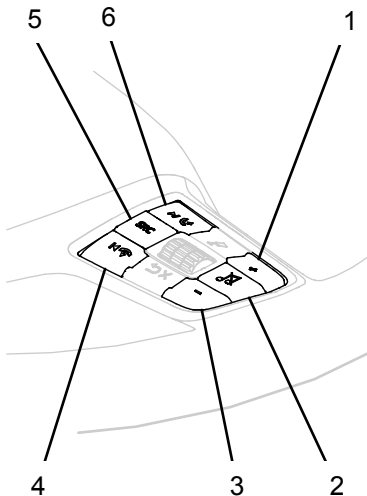

- 1. Volume increase
- 2. Mute
- 3. Volume decrease

- 4. Previous/Cancel
- 5. Media source
- 6. Next/Accept

**Dual USB Charger**

This vehicle comes standard with a dual USB 5V charging port. Both USB slots are 5V, USB-A type connections.

**Cigarette Lighter and Ashtray (Option)**

This vehicle may have the optional ashtray insert (for the cupholder) and the optional cigarette lighter instead of a power port. To operate, push in on the knob end of the lighter. After a few moments, the lighter will automatically pop out, glowing hot and ready to use. After use, insert the lighter back into the socket without pushing all the way in. The socket of the cigarette lighter may be used to operate 12V, 15 amp appliances, such as a hand spotlight or small vacuum cleaner.

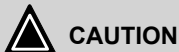

**CAUTION**

Do not attempt to operate a cigarette lighter using the 12V power port recep-

tacle. A cigarette lighter inserted into the 12V power port will heat up and be expelled into the cab, potentially causing personal injury, fire, and property damage.



**WARNING**

DO NOT place paper or other combustible substances in an ashtray, it could cause a fire. Keep all burnable materials, besides smoking materials, out of the ashtray. Failure to comply may result in death, personal injury, equipment or property damage.



**WARNING**

DO NOT exceed the voltage/ampere capacity of the accessory power port. It could result in a fire. Follow all warnings and instructions in the operator's manual for the appliance you are using. Failure to comply may result in death, personal injury, equipment or property damage.

## Glove Box

A glove box is provided to store important documents, the vehicle literature set (including this Operator's Manual), and other related materials. You can choose from a variety of other interior storage options to store your personal supplies or small tools:

- center console
- map pocket on the door
- overhead storage compartments



### WARNING

DO NOT drive with the glove box open, it can be dangerous. In an accident or sudden stop, you or a passenger could be thrown against the cover and be injured. To reduce the risk of personal injury during an accident or sudden stop, keep the glove box closed when the vehicle is in motion.



### WARNING

DO NOT carry loose objects in your cab, it can be dangerous. In a sudden stop, or even going over a bump in the

road, they could fly through the air and strike you or a passenger. You could be injured or even killed. Secure all loose objects in the cab before moving the vehicle. Carry any heavy objects such as luggage in the exterior storage compartment and close it securely.

## Dome Light

Interior cab lighting is controlled using the three-position, overhead, dome light switch:

- On – Turns on the center, overhead dome light and both the left and right, pressible, map lights.
- Center Position – Turns on the overhead dome light when either cab door is open, or when the doors are unlocked using the key fob.
- Off – Turns off the center, overhead cab light and disables both the left and right, pressible, map lights.

The wash down, ambient lighting is controlled using the dimmer switch (see [Cab and Panel Dimmer Switch](#) on page 89).

## Appliances

If your vehicle is equipped with a television or other appliance, be sure they are compatible with your vehicle's electrical system. Secure them in the cab so they cannot come loose during a sudden stop.



### WARNING

In a sudden stop or collision a heavy object in your cab could strike you or anyone with you. You could be injured or even killed. Secure any appliance (such as a radio, or TV) you add to your sleeper or cab.

## Vehicle Telematic System

Your vehicle may be equipped with an onboard telematics system. This system is a Global Positioning Satellite (GPS)-linked computer. It receives input from multiple sources to locate your vehicle. Read and understand the Supplemental Telematics and Navigation System Owner's Manual and observe the Warnings, Cautions, and Notes that follow before using the system.



**WARNING**

Verify legal weight and height restrictions for the route suggested by the telematic system. Failure to verify height restrictions could lead to causing death, personal injury or property damage. Failure to verify weight restrictions could result in a traffic infraction.



**WARNING**

Only glance at the system monitor while driving. Prolonged periods of viewing while driving could result in an accident involving death or personal injury.



**WARNING**

DO NOT program the telematic system while driving. Always stop your vehicle when programming or changing the settings on the telematic system. Programming the system while driving can cause you to take your eyes off

the road, which could result in an accident involving death, personal injury or equipment damage.



**WARNING**

Regardless of how and where the navigation system directs you, it is your responsibility to operate the vehicle in a safe and legal manner. Failure to comply may result in death, personal injury, equipment or property damage.



**WARNING**

Ensure the volume level of all audio devices is set to a level that still allows you to hear outside traffic and emergency vehicles. Failure to comply may result in death, personal injury, equipment or property damage.



**CAUTION**

DO NOT rely on the telematic system to route you to the closest emergency

services. Not all emergency services are in the database.



**NOTE**

The map database is the most current available at the time of production. The database is designed to provide you with route suggestions and does not take into account the relative safety of a suggested route or of factors that may affect the time required to reach your destination. See the Supplemental Navigation System Owner's Manual for more information.

**Using the Telematic System**

Screen Display On/Off

1. Press and hold the **POWER/LIGHT** button for approximately 1 second.
2. After the display has been turned on, the following Warning/Informational screen will appear.

### Warning/Informational Screen

<p><b>WARNING</b></p>  <p><b>DO NOT let this device distract you while driving. Always concentrate on your driving. Distractions could cause an accident resulting in injuries to you or others.</b></p>
<p><b>IMPORTANT</b></p>
<p><b>Disclaimer:</b> Map data may be inaccurate and navigation routes may not be available for larger size vehicles. Regardless of how and where the navigation system directs you, it is your responsibility to operate the vehicle in a safe and legal manner. <b>Note:</b> Before using this system, read the Owner's Manual and learn how it operates. Some functions of this system will not</p>

<p><b>WARNING</b></p>  <p><b>DO NOT let this device distract you while driving. Always concentrate on your driving. Distractions could cause an accident resulting in injuries to you or others.</b></p>
<p>operate when the truck is moving.</p>

3. After reading the information, touch the **T** in the upper right corner of the screen with your finger indicating you acknowledge and understand the information. The **MENU** screen will automatically appear next.
4. To turn the system off, press and hold the **POWER/LIGHT** button for 3 seconds.
 

**Disclaimer:** The vehicle manufacturer is not responsible for erroneous map data, misrouting or any downtime or other damages associated with or arising out of the use of the Navigation System.

## Chapter 4 | DRIVING

Starting and Operating.....	117
Starting and Warming Up.....	117
Engine Operations.....	121
Transmission.....	128
Hydraulic Brakes.....	133
Air Brake System (option).....	135
Brake Safety and Emergency.....	141
Retarders.....	144
Axle and Suspension.....	147
Fifth Wheel.....	156
Driving Tips and Techniques.....	161
Stopping the Vehicle.....	163
Antilock Brake Systems (ABS).....	165

## Starting and Operating

For detailed information on starting and operating the engine, refer to the Engine Operation and Maintenance Manual provided with your vehicle.

Since each vehicle is custom-equipped, all engine operation instructions in this manual are general. You will want to consult the manual for your engine to find out details about your specific engine's needs. You may need to use a slightly different procedure from the one outlined here.

Also, read the American Trucking Association's (ATA) Truck Driver's Handbook. It will give you tips on starting, shifting, and driving your vehicle. This section includes instructions for both Normal Temperature starting and Cold Weather starting. The engine type (brand) and size determines what type of cold weather starting aid is installed in your vehicle. Refer to your Engine Operation and Maintenance Manual to learn what precautions you should take before starting the engine. Many new electronic engines cannot use ether or other starting fluids. These engines are equipped with a flame-start air intake heating system. See [Tips to](#)

[Remember When Starting Vehicle in Cold Weather](#) on page 118.



### WARNING

Do not use starting fluids with this engine. This engine is equipped with an intake air heater: use of starting fluid can cause an explosion, fire, personal injury, severe damage to the engine, and property damage.



### WARNING

NEVER start or let the engine run in an enclosed, unventilated area. Exhaust fumes from the engine contain carbon monoxide, a colorless and odorless gas. Carbon monoxide can be fatal if inhaled. Failure to comply may result in property damage, personal injury, or death.



### CAUTION

Do not park or operate the vehicle in areas where the hot exhaust system

may come in contact with dry grass, brush, spilled fuel, or other material that can cause a fire.

## Starting and Warming Up

### How to Start Vehicle in Normal Weather



### CAUTION

Never operate the starter motor while the engine is running. The starter and flywheel gears could clash or jam, severely damaging them.



### NOTE

Some starters are equipped with over-crank protection. Check the Engine Operation and Maintenance Manual for details.

When the outside temperature is above 50°F (10°C), you can use the following

procedure. If Anti-Theft is enabled, the first time you turn the ignition switch to START, you will need to enter the Passcode.

1. Set the parking brake.
2. Put your main transmission in Neutral.
3. Disengage (depress) the clutch (with manual transmission).
4. Turn the ignition switch to START.



**NOTE**

If Anti-Theft is enabled, you will need to enter the Passcode in order to start the engine (see Anti-Theft).

5. If the engine does not start within 30 seconds, release the ignition switch. To avoid overtaxing the starter motor or the batteries, don't use the starter for more than 30 seconds. Let the starter motor cool and the batteries recover for two minutes before trying again. If the engine still won't start after a couple of tries, check the fuel lines for possible fuel starvation or air leaks. Starting failure may mean fuel is not reaching the injectors.

6. As soon as the engine starts, begin to watch the oil pressure gauge. Check your engine manufacturer's manual for the right pressure for your engine. If the oil pressure doesn't rise within a few seconds, stop the engine. Find out what is wrong before restarting the engine.
7. Slowly engage (release) the clutch after the engine has started.
8. Wait for the oil pressure gauge to reach normal operating pressure before operating the vehicle or idling faster than 1,000 rpm.

**Tips to Remember When Starting Vehicle in Cold Weather**

If you follow a few simple guidelines, you will extend the service life of your engine:

- Keep the electrical system in top condition.
- Use the best quality fuel of the recommended grade.
- Use recommended engine lubricating oil.
- For manual transmissions and auxiliary transmissions, leave the transmission in neutral and allow the transmission lubricating oil to

warm up (approximately 3-5 minutes) before operating vehicle.

**Engine Block Heater (Option)**

To preheat the engine before starting, plug the optional engine block heater into a properly grounded AC electrical source. DO NOT start the engine with the heater plugged in.



**WARNING**

Engine block heaters can cause fires which may result in property damage, personal injury, or death if not properly maintained and operated. Regularly inspect the engine block heater wiring and connector for damaged or frayed wires. DO NOT use the heater if there are any signs of problems. Contact your authorized dealer or the manufacturer of the heater if you are in need of repairs or information.



**CAUTION**

Always unplug heater before starting the engine. Damage to the cooling system could occur if the heater is not turned OFF (unplugged).

Depending on engine make, when the temperature falls below  $-10^{\circ}\text{F}$  ( $-24^{\circ}\text{C}$ ), the block heater is required.

**Engine, Under Hood Air Intake**

This switch opens a door in the engine air filter housing so that the air is taken from under the hood instead of outside air. This switch can be useful when starting the vehicle in cold weather conditions.

**CAUTION**

Only operate the under hood intake air switch when outside temperatures are

below  $32^{\circ}\text{F}$  ( $0^{\circ}\text{C}$ ). Engaging the under hood air intake while temperatures are above freezing may result in engine damage.

**Engine Warm Up**

Engine warm-up allows oil film to be established between pistons and liners, shafts and bearings while your engine gradually reaches operating temperature.

1. After you've started your engine, idle it at approximately 600 rpm while you check:
  - Oil pressure
  - Air pressure
  - Alternator output
2. After a few minutes of idling at 600 rpm, increase your idle speed to 900 or 1,000 rpm. Continue your warm-up. This procedure allows oil to warm and flow freely while pistons, liners, shafts, and bearings expand slowly and evenly. In extremely cold temperatures, you may have to increase idle speed.
3. Continue the engine warm-up until the coolant temperature reaches at least  $130^{\circ}\text{F}$  ( $54^{\circ}\text{C}$ ). At this temperature, you can use partial throttle. Wait until the coolant temperature is at least  $160^{\circ}\text{F}$  ( $71^{\circ}\text{C}$ ) before operating at full throttle.

**NOTE**

In colder climates where the temperature is often below freezing, the warm-up for turbocharged engines is especially important. Chilled external oil lines leading to the turbocharger will slow the oil flow until the oil warms, reducing oil available for the bearings. Watch the engine oil temperature or pressure gauge for a warming trend before increasing engine idle speed (rpm).



**NOTE**

Under most circumstances, idling your engine for long periods merely wastes fuel. In severe arctic weather conditions, however, you may need longer idling to be sure all parts of your engine are fully lubricated.



**WARNING**

Exhaust fumes from the engine contain carbon monoxide, a colorless and odorless gas. DO NOT breathe the engine exhaust gas. A poorly maintained, damaged, or corroded exhaust system can allow carbon monoxide to enter the cab. Entry of carbon monoxide into the cab is also possible from other vehicles nearby. Failure to properly maintain your vehicle could cause carbon monoxide to enter the cab, resulting in personal injury or death.



**WARNING**

Never idle your vehicle for prolonged periods of time if you sense that ex-

haust fumes are entering the cab. Investigate the cause of the fumes and correct it as soon as possible. If the vehicle must be driven under these conditions, drive only with the windows open. Failure to repair the source of the exhaust fumes may result in death, personal injury, equipment or property damage.



**WARNING**

To reduce the chance of personal injury, vehicle damage, and/or death from overheated engines, which can result in a fire, never leave the engine idling without an alert driver present. If the engine does overheat, as indicated by the engine coolant temperature lamp, immediate action is required to correct the condition. Continued unattended operation of the engine, even for a short time, may result in serious engine damage or a fire. Failure to comply may result in death, personal injury, equipment or property damage.



**CAUTION**

The use of a winterfront can result in excessive coolant, engine oil, and intake air temperatures, which may lead to overheating and possible engine damage.



**CAUTION**

DO NOT allow your engine to idle, at low rpm (400-600 rpm), longer than five minutes. Long periods of idling after the engine has reached operating temperatures can decrease engine temperature and cause gummed piston rings, clogged injectors, and possible engine damage from lack of lubrication. The normal torsional vibrations generated can also cause transmission wear.

**NOTE**

Keep the engine exhaust system and the vehicle's cab ventilation system properly maintained. It is recommended that the vehicle's exhaust system and cab be inspected (1) By a competent technician every 15,000 miles (24,140 km); (2) Whenever a change is noticed in the sound of the exhaust system; or (3) Whenever the exhaust system, underbody, or cab is damaged.

**NOTE**

If you are parked next to idling vehicles, move your vehicle or do not stay in your vehicle for prolonged periods of time.

**How to Warm Up the Transmission**

In cold weather (below 32°F (0°C), you may find shifting sluggish when you first start up. Transmission warm-up is especially important at this time, but it is always a good idea to warm-up your

transmission before starting out on the road.

To warm-up the transmission lubricating oil during engine warm-up, with a single transmission (manual and automatic):

1. Put the transmission in Neutral.
2. Release the clutch pedal (manual only) and operate the transmission in neutral for 3 to 5 minutes prior to operating the transmission in either forward or reverse range.
3. If you have a two-transmission combination:
  - a. Put the main transmission in gear.
  - b. Put the auxiliary transmission in Neutral. This will allow the transmission countershaft to turn, agitating the oil and warming it.

When enabled, the tachometer will represent PTO operation, and may display the following additional PTO related information:

- Engine RPM – indicated near the tachometer as well as on the scale line.
- PTO hours – shows engine hours used during PTO activity.
- DPF Status – shows Diesel Particulate Filter usage as a percentage.
- Engine Torque – shows the percentage of max engine torque being exerted.

Dependent on your engine these modes can be read inside the tachometer. For more information on PTO operation see [How to Start the PTO](#), [How to Stop the PTO](#), and/or consult your PTO manufacture's operating instructions.

**Engine Operations****PTO Operations (option)**

This truck may be equipped with Power Take-Off (PTO). PTO operation is enabled by using the dash mounted PTO switch in conjunction with the cruise control feature.

**How to Start the PTO**

The PTO operation can be enabled and activated in many different ways. Refer to your PTO manufacturer's Operating Instructions for specific guidance on how to operate the PTO. The information below provides the basic process of enabling and activating PTO and what the operator

should observe during this process; however, defer to your PTO manufacturer's Operating Instructions in all cases where there is a disagreement in instruction.



**NOTE**

Actual PTO engagement/disengagement may be delayed momentarily since it is controlled by the air system and mechanical movement.



**CAUTION**

Increasing engine rpm before the PTO is actually engaged could prevent the PTO from engaging and/or cause PTO damage.

1. Toggle the **PTO ON/OFF** switch to the ON position. Text indicating PTO engagement will appear at the center of the display. Vehicles with PACCAR or an Eaton automated transmission will display the letters **AN** in the transmission gear indicator.
2. Press the Cruise Control (CC) **ON/OFF** button to enable PTO

speed control operations. A white speed control enabled icon will appear

3. Press the **SET +** and **RES –** Cruise Control (CC) buttons to command a desired engine speed. PTO Speed Control is now active.
4. To increase or decrease PTO engine speed use a combination of short and long presses of the **SET +** and **RES –** Cruise Control (CC) buttons.

PTO speed indicates on the digital tachometer and below it, as a numerical readout.

**How to Stop the PTO**

When PTO Speed Control is active, there are many ways to disable it depending on how the vehicle is configured.

- Tap the service brake
- Engage the clutch
- Turn Cruise Control Off
- Release the Parking Brake - (This is applicable only if PTO was activated while the truck was stationary.)
- Toggling the **PTO switch** to OFF

Stopping the PTO will return the engine speed to its default setting. It is not advised to stop the PTO when engine speed is above the default setting. Remember, to quit PTO operations fully, toggle the **PTO switch** to OFF.

**Engine Fan Control**

The engine fan switch on the dash has a manual and an automatic mode. In the manual mode, the engine fan will engage until the switch is back into automatic mode. In automatic mode, the engine fan operation is controlled by the engine computer.

**WARNING**

DO NOT work on or near the fan with the engine running. Anyone near the engine fan when it turns on could be injured. If it is set at MANUAL, the fan will turn on any time the ignition key switch is turned to the ON position. In AUTO, it could engage suddenly without warning. Before turning on the ignition or switching from AUTO to MANUAL, be sure no workers are near the fan. Failure to comply may result in death or personal injury.

**CAUTION**

DO NOT operate the engine fan in the MANUAL position for extended periods of time. The fan hub was designed for intermittent operation. Sustained operation will shorten the fan hub's service life as well as reduce fuel economy.

**CAUTION**

The fan or equipment near it could be damaged if the fan turns on suddenly when you do not expect it. Keep all tools and equipment away from the fan.

**Using a Winterfront****CAUTION**

The use of a winterfront can result in excessive coolant, engine oil, and intake air temperatures, which may lead to overheating and possible engine damage.

**CAUTION**

A winterfront should only be used at temperatures below 40°F (4°C). Use of a winterfront above 40°F (4°C) can decrease life of cooling module components. Remove winterfront as soon

as the ambient temp reaches 41°F (5°C). The use of a winterfront above 40°F (4°C) can result in excessive coolant, engine oil, and intake air temperatures, which may lead to overheating and possible engine or coolant module damage and emissions non-compliance.

The winterfront is designed to minimize the temperature differences across the radiator and reduce the possibility of cooling module damage. Aftermarket winterfronts may not provide the proper airflow distribution and could cause cooling module damage.

**Engine Aftertreatment System**

This vehicle has an Engine Aftertreatment

System (EAS), to control vehicle exhaust emissions. The Engine Aftertreatment system consist of a Diesel Particulate Filter (DPF), Selective Catalyst Reduction (SCR), DPF Switch and warning lights. The DPF will trap soot from the engine exhaust gases. The SCR uses Diesel Exhaust Fluid to reduce the levels of NOx in the engine exhaust. The EAS will periodically clean (regenerate) the DPF.

Your vehicle may be equipped with an additional feature designed to alert a remote operator that the aftertreatment system requires a regeneration. When the EAS detects a heavily loaded DPF it will sound the city horn for 10 seconds while continuously flashing the vehicle headlamps. The operator can resolve and reset the alert by performing a parked regeneration. Alternatively, the notification can be dismissed by pressing the clutch or the service brake. Dismissing the alert does not reset it, the next alert will occur at the next higher soot level if a parked regeneration is never performed.

Engine Aftertreatment System Detail

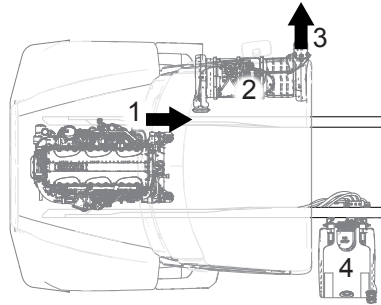

1. Hydrocarbon doser from turbo
2. Aftertreatment unit (DPF, DEF doser and SCR)
3. Filtered/treated exhaust
4. Diesel exhaust fluid (DEF) tank

Please refer to the Engine Aftertreatment System Supplement provided with the vehicle for more detailed description of functionality and warnings.

## Cruise Control



### WARNING

DO NOT operate the cruise control when operating on road surfaces with poor traction (wet, icy, or snow covered roads) or in heavy traffic. Accelerations caused by the normal operation of the cruise control could cause you to lose control of the vehicle resulting in an injury accident.

Cruise control functions and features may vary depending upon which engine you have. For a specific explanation of your cruise control, see the cruise control or engine manual included with your vehicle. This vehicle's electronic system will perform a 'rationality check' every time the vehicle is started. This check is to ensure that the service brakes are working before allowing cruise control to function. This safety feature is designed to ensure that a driver is able to cancel the cruise set speed by using the service brake pedal. The system will not allow cruise control operation if it does not pass the 'rationality check.' The display will prompt you to press the service brake pedal if it has not

been pressed since the vehicle has been started. In vehicles with Eaton transmissions, the cruise control switches may be located on the shift control knob. The left switch pod on the steering wheel contain buttons for the cruise control.

**Left Switch Pod**

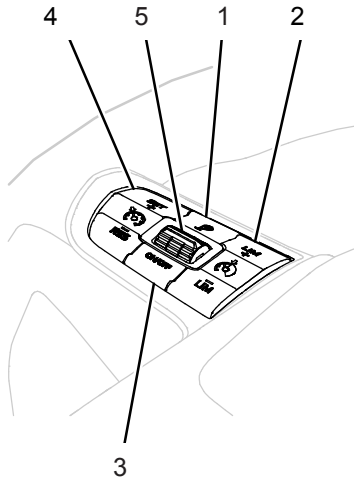

1. **Trip**
2. Variable Road Speed Limiter (VRSL) **LIM+** and **LIM-**
3. Cruise Control **ON/OFF**
4. Cruise Control (CC) **SET+** and **RES-**
5. **Toggle**

The switches on the left side of horn pad manage vehicle speed functions like cruise control and variable road speed limiter (option). If the vehicle has adaptive cruise control (option), predictive cruise control (option), etc., the toggle switch is also used to operate that system.

**How to Set Cruise Control Speed**

The vehicle speed must be greater than 19 mph (30 kph) for PACCAR powered vehicles or 30 mph (49 kph) for Cummins powered vehicles and the engine speed must be over 1,100 rpm for the cruise set speed to work.

This vehicle may have Cruise Control buttons located on the steering wheel instead of the switches on the dash.

1. Turn on the cruise function using Cruise Control **ON/OFF**  
The Cruise Control indicator appears on the display.



2. Accelerate the vehicle using the accelerator pedal to the desired cruise speed.
3. Press **SET** to set the cruise speed.



**NOTE**

Cruise Control may not hold the set speed going down hills. If the speed increases going down a hill, use the brakes to slow down. This will cancel Cruise Control.

The Cruise Control indicator turns green (indicating a cruise speed has been set) with the cruise speed appearing beside it.

**How to Change Cruise Set Speed**

The vehicle cruise control must be on and the cruise speed engaged.

1. To increase speed:
  - Press the **"+"** button on the Right Steering wheel pod if available, or

- Press the **SET** portion of the **SET/RESUME** switch on the dash
- 2. To decrease speed:
  - Press the "-" button on the Right Steering wheel pod if available, or
  - Press the **RESUME** portion of the **SET/RESUME** switch on the dash

### Canceling and Resuming Cruise Control

This vehicle may have Cruise Control buttons located on the steering wheel instead of the switches on the dash. There are three ways to cancel the set speed in Cruise Control:

1. Tap the brake pedal
2. Tap the clutch pedal
3. Turn the Cruise Control system OFF (using Cruise Control **ON/OFF**)



Using the brake or clutch pedal to cancel set speed allows the operator to use the

**RESUME** feature. Pressing **RESUME** will resume the vehicle speed previously set. When turning the system off, the previous set speed is removed from memory. The operator will have to manually reset the cruise speed.

### Adaptive Cruise Control (Option)

**WARNING**

The Adaptive Cruise Control system in this vehicle is not autonomous and requires human interaction. The driver must always remain alert and ultimately is the one still responsible for safe vehicle control. The driver must monitor the driving environment and be ready to intervene at any moment. Failure to comply may result in property damage, personal injury, or death.

This vehicle may be equipped with Adaptive Cruise Control (ACC) to enhance standard cruise control. With a forward radar and camera to detect objects in front of the vehicle, ACC will adjust the speed of the truck to maintain a set following distance when the Cruise Control is active.

### Following Distance Alerts

The display will be white when the vehicle in front is at a proper distance ahead of the truck. If the following distance decreases (less than 1.5 seconds), the following distance bars will turn amber and an audible alert will occur. When the following distance decrease more (0.5 seconds), the bars will turn red and the audible alert will quicken.

### Collision Alerts Driver Screens

The digital display will show the **BRAKE** graphic and produce a fast, audible alert if the system detects a collision either from approaching speed or because of a stationary object.

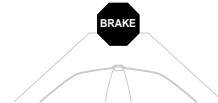

Some vehicles may present the **OBJECT DETECTED** graphic to the driver, which will also produce a fast, audible alert. This is an optional icon and may vary depending on the specifications of the truck.





Both of these conditions can occur when Cruise Control and Adaptive Cruise Control are not active, providing the vehicle is moving faster than 15 mph / 24 kph.

### Set ACC Following Distance

The ACC following distance can only be adjusted for those vehicles equipped with the optional, steering wheel controls.

Vehicles equipped with the Menu Control Switch (MCS) use a standard, three bar, following distance.

1. Press the **Toggle** until the following distance bars illuminate in the view.

If the vehicle has Predictive Cruise Control, you may have to press the Toggle multiple times until the following distance bars are selected.

2. Deflect the **Toggle** up or down to choose the number of following distance bars.
3. Press the **Toggle** again to set the new following distance.

### Lane Departure Warning (Option)

A visual and audible alert will occur when a lane marking is unintentionally crossed. The operator can mute the Lane Departure Warning (LDW) audible alarm by using the **Lane Departure/ Electric Steer Assist** switch.



### Lane Keeping Assist (Option)

Vehicles with Lane Keeping Assist will provide steering assistance to the steering wheel when it detects the vehicle is departing a lane without use of a turn signal. The system will turn the steering wheel in an attempt to nudge the vehicle in back into the lane. The steering assistance may always be overcome by the driver and the driver is expected to keep hands on the steering wheel at all times. Using this feature may increase or decrease awareness to components that are in need of inspection or maintenance, such as (but not limited to) improper tire inflation, suspension, or brake drag.

The Lane Keeping Assist feature is enabled by default when the vehicle is on as indicated by a white icon. When the vehicle speed is above 40 MPH (65 km/h), the conditions are right, and the system is ready to assist in keeping the vehicle in the lane, the steering wheel portion of the icon below will turn green, indicating that the system is engaged and ready to assist in keeping the vehicle in the lane. The system may disengage if the system operating conditions are not met and re-engage once met. Some of these conditions include lane marking detection, vehicle speed, and system faults.

#### Lane Keeping Assist Enabled





**WARNING**

Ultimate responsibility for the safe operation of the vehicle remains with the driver at all times. Even with Lane Departure Warning or Electric Steer Assist, the driver must remain alert, react appropriately and in a timely manner, and use good driving practices. Failure to do so may result in death, personal injury and/or property damage.

Lane Keeping Assist Engaged



For the Lane Keeping Assist feature to safely operate, the driver must remain in control of the vehicle with their hands on the wheel. If the system cannot detect the presence of the driver's hands on the wheel, it will disengage the Lane Keeping Assist feature. After some time of not detecting the driver's input to the wheel, a warning will be given to keep hands on the wheel.

**Air Filter Restriction Indicator (Option)**

An Air Filter Restriction Indicator may be installed on the air filter housing or air induction piping for access to clean, filtered air.

As the filter plugs and restriction increases, a red indicator will appear in a window on the indicator. When red appears, the air filter should be replaced. The indicator can be reset by pressing the button at the end of the indicator.

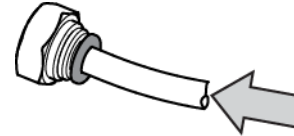
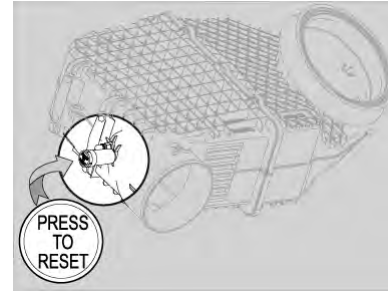

**PUSH**  
(EMPUJAR;  
POUSSER)

**Transmission**

**Transmission Tips**

**Riding the Clutch**

The clutch is not a footrest. DO NOT drive with your foot resting on the clutch pedal. It

will allow your clutch to slip, causing excessive heat and wear, damage could result.

### Release Bearing Wear

When you must idle your engine for any period of time, shift your transmission to neutral and disengage the clutch (take your foot OFF of the pedal). This helps prevent unnecessary wear to your clutch release bearing, and is less tiring for you, too.

### More Tips

- Always use the clutch when making upshifts or downshifts.
- Always select a starting gear that will provide sufficient gear reduction for the load and terrain.
- Never downshift when the vehicle is moving too fast.
- Never slam or jerk the shift lever to complete gear engagement.
- Never coast with the transmission in neutral and the clutch disengaged. To provide smooth gear engagements while shifting, use proper coordination between shift lever and clutch.
- Double clutching is a very effective means to increase the service life

of your transmission. Double clutching refers to a technique where the clutch pedal is used twice per shift instead of once. It also requires that you adjust the engine rpm in the middle of the shift which ultimately synchronizes the gears during shifting. Synchronizing reduces wear on the gears.

### Transmission Oil Temperature Gauge (option)

The Transmission Temperature optional Gauge, indicates the temperature of the oil in the transmission. Watch this gauge to know when the transmission is overheating: if it is, have it checked by an authorized service representative.

### Transmission Gear Display

M 6 D  
▲ N  
R

Indicating clockwise from the upper-left:

- Transmission mode
- Current gear
- Drive mode

- Gear Shift Assist (option)

Vehicles with PACCAR or Eaton automated transmissions will show the transmission mode, current gear, and diagnostic information associated with the transmission. This display does not apply for vehicles with Allison transmissions.

### Operating Manual Transmissions

The transmission shift pattern for your vehicle may be located on the shift control knob. In addition to understanding the shift pattern and its location, you should read the transmission manufacturer's manual provided with your vehicle before operating the vehicle. After making sure the vehicle's oil and air pressure are correct and all other parts and systems are in proper working condition:

1. For vehicles with a clutch pedal, locate the clutch pedal and engage the clutch brake.
2. Shift into a low gear.

**CAUTION**

Always use first gear or a low speed range to start the vehicle in motion. The use of a higher gear or speed range forces undue strain on the engine, clutch, and other transmission components, and may cause damage.

3. Evaluate the road surface conditions and terrain your vehicle is on. Select a gear low enough to let your vehicle start forward with the throttle at idle.
4. Push the parking brake valve handle (yellow) against the dash panel to release the brakes.
5. Release the clutch pedal (manual only), then gradually accelerate to permit smooth starting.
6. DO NOT allow your vehicle to roll (even a little) in the opposite direction during clutch engagement. If you need to start up on an incline, apply your service brakes before you release the parking brake. Then release your service brakes as you engage the clutch and apply throttle.

For further instructions on operating your transmission, see the transmission manufacturer's Driver/Operator's Instruction Manual.

If you want to shift directly into any gear other than first or reverse, depress the clutch pedal only far enough to release the clutch. Fully depressing the pedal applies the clutch brake and could cause gear hang-up.

If you have a misaligned gear condition in your vehicle's transmission and cannot start, gradually release the clutch, allowing the drive gear teeth to line up properly. Then the drive gear can roll enough to allow the teeth to line up properly and complete the shift. The best engine performance and maximum economy is obtained if gears are properly selected. This efficiency is achieved by always selecting gears within optimum engine rpm, which is where maximum torque and power are obtained.

Shift carefully in a new vehicle. The transmission may be a little stiff at first. Avoid gear clashing, by closely following these procedures. When you are operating a new vehicle or one that has been exposed to cold weather, you want the transmission lubricant (fluid) to circulate and coat the contacting surfaces of the

gears. Metal contacting metal in moving parts may seriously damage your transmission, do not drive in one gear for long periods of time until the transmission lubricant has a chance to coat all contacting surfaces.

- Always select a starting gear that will provide sufficient gear reduction for the load and terrain.
- Never downshift when the vehicle is moving too fast.
- Never slam or jerk the shift lever to complete gear engagement.
- Never coast with the transmission in neutral and the clutch disengaged.

## How to Use the Hydraulic Clutch



### CAUTION

Be careful not to apply the clutch brake while the vehicle is moving. The purpose of the clutch brake is to stop the transmission so that you can shift into a starting gear without grinding gears. Applying the clutch brake when the vehicle is moving causes a braking effect on the drivetrain and shortens the service life of the clutch brake.



### CAUTION

DO NOT push the clutch pedal completely to the floor when shifting while the vehicle is in motion. Using the clutch brake while shifting a vehicle in motion will damage the clutch brake. A non functioning clutch brake will make shifting very difficult when the vehicle is stationary.

1. Depress the clutch pedal past the first 1/2 in. (13 mm) for approximately 5 1/2 in. (139.7 mm) of total pedal travel.

2. Depress the clutch pedal another 1/2 in. (13 mm) to engage the clutch brake.

The clutch brake is used for stopping transmission gears, allowing you to easily shift into first gear or reverse without grinding gears. The clutch brake is not necessary when shifting into other gears while in motion.

If the clutch pedal is pressed completely to the floor and the transmission is not shifting, then it is time to have the clutch adjusted or serviced.

If the transmission has a butt-tooth condition and you cannot engage a gear, gradually release the clutch. Then the drive gear can roll enough to allow the teeth to line up properly and complete the shift. The clutch is not a footrest. Do not drive with your foot resting on the clutch pedal. It will allow your clutch to slip, causing excessive heat and wear, damage could result.

When you must idle your engine for any period of time, shift your transmission to neutral and disengage the clutch (take your foot OFF of the pedal). This helps prevent unnecessary wear to your clutch release bearing, and it is less tiring for you, too.

- Always use the clutch when making upshifts or downshifts.

- Never coast with the transmission in neutral and the clutch disengaged.
- To provide smooth gear engagements while shifting, use proper coordination between shift lever and clutch.

## How to Shift Using Double Clutch Method

Double clutching is easier on the transmission and on the engine, helping match your vehicle's engine speed with driveline speed to achieve clash-free shifts. The manual transmission in your vehicle is not equipped with gear synchronizers. Whether you are upshifting or downshifting, it is best to double clutch. To double clutch:

1. Push the clutch pedal down to disengage the clutch.
2. Move the gear shift lever to neutral.
3. Release the pedal to engage the clutch. This lets you control the rpm of the transmission mainshaft gears, allowing you to match the rpm of the mainshaft gears to those of the output shaft.

- Upshifts: let the engine and gears slow down to the rpm required for the next gear.
  - Downshifts: press accelerator, increase engine and gear speed to the rpm required in the lower gear.
4. Now quickly press the pedal to disengage the clutch and move the gear shift lever to the next gear speed position.
  5. Release the pedal to engage the clutch.

### Automatic Transmissions

An automatic transmission makes shifting much easier. It remains important to completely understand how to operate the transmission to optimize its efficiency. Please read the manual for your automatic transmission included with your vehicle.



#### WARNING

DO NOT leave the cab of your vehicle without applying the parking brake. The truck could roll and cause an accident resulting in death or personal in-

jury. Always apply the parking brake before you leave the cab.

### Automated Transmissions

This vehicle may have a PACCAR or Eaton automated transmission. It remains important to completely understand how to operate the transmission to optimize its efficiency. Please read the manual for the automated transmission included with your vehicle.

Not all automated transmissions have a "park" position, so you will need to apply the parking brake before leaving the cab.



#### WARNING

If your vehicle has an automated transmission, be aware that it can roll backwards when stopped on a hill or grade, or when starting from a stop on a hill or grade. Failure to comply may result in death, personal injury, equipment or property damage. Observe the following guidelines: (1) When stopped on a hill or grade, press the brake pedal. (2) When starting from a stop on a hill or grade, quickly remove your foot

from the brake pedal and firmly press on the accelerator pedal.



#### WARNING

DO NOT leave the cab of your vehicle without applying the parking brake. The truck could roll and cause an accident resulting in death or personal injury. Always apply the parking brake before you leave the cab.

### Hill Hold



The hill hold feature is available as an option with certain automated transmissions. This feature holds the vehicle while on a hill to allow the operator to release the service brakes and press the accelerator. This feature will hold the vehicle if the vehicle is attempting to go up a hill from a stop in either drive or reverse.

### Shift Configuration

Some transmissions are equipped with more than one shifting configuration to match various operating conditions. Please

read the automated transmission manual included with your vehicle for instructions on how to change shift configurations.

### Controls for Vehicles with an Eaton Automated or a PACCAR Transmission

This vehicle may be equipped with either an Eaton Automated or a PACCAR Transmission. The Automated or PACCAR Transmission controls are located on the right hand side of the steering column.

### Auxiliary Transmission

If you have an auxiliary transmission, see your transmission manufacturer's manual for its proper operation.

### Steerable Drive Axle



#### NOTE

The customer cannot change axle ratios or tires without first obtaining approval from PACCAR. Contact your nearest dealer.

If you have a Steerable Drive Axle installed on your vehicle, refer to the auxiliary transmission/transfer case manufacturer's

Driver/Operator's Instruction Manual to learn how to operate correctly.

## Hydraulic Brakes



#### WARNING

Do not operate the vehicle in the event of a malfunction in any air or hydraulic circuit. Such a malfunction may prevent the brake system from operating properly, and could result in an injury accident. The vehicle should not be operated until the system is repaired and both braking circuits, including all pneumatic, hydraulic, and mechanical components are working properly.

The operation of the vehicle's braking system is based on the principle of hydraulics. Hydraulic action begins when force is applied to the brake pedal. This force creates hydraulic pressure in the master cylinder and is amplified with assistance of a power booster. The supplemental boost in force is developed when pressurized power steering fluid from the steering pump presses on the master cylinder piston. As a safety precaution, the

pressurized fluid from the master cylinder has two mutually independent circuits. The primary circuit supplies the front wheels while the secondary circuit supplies the rear wheels. The displaced fluid from the master cylinder travels through brake pipes terminating at the wheel cylinders which actuate the brake pad mechanisms. Actuation of these mechanisms force the brake pads against the rotors to stop the wheels.

A reserve electric motor pump provides a redundant power source for the hydraulic booster in the event normal flow from the power steering pump is interrupted. Manual braking is also available in the event both the power and reserve systems are inoperative.



#### WARNING

Never drive your vehicle with the parking brake applied. Always release the parking brakes prior to moving the vehicle. Failure to disengage the parking brakes prior to moving your vehicle could result in excessive heat buildup in the brake system, resulting in a fire. Failure to comply may result in property damage, personal injury, or death.



**NOTE**

Today's diesel engines have significant torque and startability power at low rpm. Combinations of engine speed and available torque may over-power the vehicle's parking brakes.

4

**Engaging the Parking Brake**

Vehicles with hydraulic brakes use a manually operated driveline parking brake, actuated by lever and cable. Pulling upward on the parking brake lever pulls the cable and engages the brake.



**CAUTION**

Unless it is an emergency, do not pull upward on the parking brake lever while the vehicle is moving. Attempting to stop with the parking brake could cause damage to the driveline, transmission, or the parking brake mechanism itself.



1. Come to a complete stop.
2. Press down completely on the service brake pedal.
3. Pull up on the parking brake lever until it reaches an over (top) center position.

The parking brake indicator on the dash will come on prior to brake being fully applied:



4. Release the service brake pedal. Ensure the lever is over center.

**Releasing the Parking Brake**



**NOTE**

Failure to fully release the parking brake before moving can cause the brakes to overheat.

1. Press down completely on the service brake pedal.
2. Press the parking brake release at lever top and lower the lever to the floor.  
The Parking Brake indicator on the dash will turn off prior to brake being fully disengaged.
3. Release the service brake pedal.

**Parking Brake Burnishing**

This procedure is recommended for new vehicles where less lever actuation force is required. This procedure is mandatory whenever the driveline brake shoes or brake drum are replaced.



**WARNING**

If a new drum or new brake shoes are installed, the driveline brake must be burnished. Failure to properly burnish the parking brake before putting it in service could result in an inoperative parking brake, possible vehicle roll-away, and serious personal injury or damage to the vehicle.

1. Drive the vehicle at 15 mph (24 km/h) in a low gear (first or second) on a dry, hard road surface.
2. Apply the parking brake lever with a moderate force (approximately 40 pounds) until the vehicle is brought to a stop. Do not allow the wheels to lock up.
3. After stopping, release the parking brake lever and drive the vehicle at 20 mph (32 km/h) in a low gear for approximately 2.5 miles, to allow the brake drum to cool.
4. Repeat steps 1, 2, and 3 above until a total of 10 stops have been completed.

5. Adjust the parking brake lever. See the *Medium Duty Maintenance Manual*.

**ABS Warning Lamp**

The ABS warning lamp will come on briefly, then go off, when the key switch is first turned on. If the lamp remains ON until a speed of 4 mph (6 km/h) is reached, then goes OFF, there may be a stored fault code. If the lamp remains ON when a speed in excess of 4 mph (6 km/h) is reached, there may be an active fault in the ABS system.

**CAUTION**

If the ABS warning light does not illuminate when the ignition is first turned on, there is a problem with the bulb or wiring. You should have this checked as soon as possible.

**WARNING**

No indication will be given via the dashboard warning lights or buzzer if tires of the wrong size are installed on

your vehicle. The Anti-Lock Brake System (ABS) is calibrated for the specific tire revolutions per mile. Use of a tire and/or wheel size different from that originally installed on your vehicle may cause the ABS system to not function during a hard braking event. This could cause an accident or serious personal injury. Consult with your dealer before using a different tire and/or wheel size than was originally installed on your vehicle.

**Air Brake System (option)**

This vehicle's braking system and many vehicle accessories may depend on the storage and application of a high-pressure air supply. For vehicles equipped with an air brake system, the service brake, parking brake, and trailer brake will utilize this supply.

Vehicles equipped with an air brake system are of the dual circuit type: it has a circuit for the front wheels, a separate circuit for the rear wheels, and one for the trailer. The system is supplied by an engine-driven compressor. The vehicle's compressor

takes outside air and compresses it, usually to 100-130 psi (689-896 kPa). The compressor air then goes to the air tanks to be stored until needed.

When you operate your air brakes, the stored compressed air flows into the chambers where it is used to apply your truck and trailer brakes. That is why, when you push down on the brake pedal, you do not feel the same amount of pressure on the pedal that you do when you apply the brakes on your car. All you are doing on your truck is opening an air valve to allow air to flow into the brake chambers.



**WARNING**

The antilock brake system is a critical vehicle safety system. For the safety of you and others around you, have the vehicle submitted for periodic preventive maintenance checks as well as having any suspected problems immediately checked by an authorized dealer. Failure to properly maintain your brake system can lead to serious accidents. Failure to comply may result in property damage, personal injury, or death.



**WARNING**

Never drive your vehicle with the parking brake applied. Always release the parking brakes prior to moving the vehicle. Failure to disengage the parking brakes prior to moving your vehicle could result in excessive heat buildup in the brake system, resulting in a fire. Failure to comply may result in property damage, personal injury, or death.



**NOTE**

Today's diesel engines have significant torque and startability power at low rpm. Combinations of engine speed and available torque may over-power the vehicle's parking brakes.

**Front Brake System**

When the brake pedal is depressed, the front circuit portion of the treadle valve delivers air from the front service air tank to the front axle brake chambers via a quick-release valve.

Simultaneously (on full truck configurations), air is also supplied to the modulating valve control port. In the event of a rear service circuit failure, the modulating valve will exhaust air from the spring brake chambers, applying the spring brakes in proportion to the front circuit application.

**Rear Brake System**

When the brake pedal is depressed, the rear circuit portion of the treadle valve delivers air from the rear service air tank to the service brake relay valve control port. The relay valve then delivers air directly from the rear service air tank to the rear brake chambers in proportion to the treadle pressure.

**Using the Parking Brake**

The yellow diamond-shaped knob on the dash controls the vehicle parking brakes. These are spring brakes that you activate by releasing air pressure from their chambers. When they are not in use, air pressure compresses the springs and releases the brakes. Pulling the valve OUT applies the parking brake, which exhausts air from the chambers and allows the springs to extend and apply the brakes.

**WARNING**

DO NOT leave the cab of your vehicle without applying the parking brake. The truck could roll and cause an accident resulting in death or personal injury. Always apply the parking brake before you leave the cab.

Combination (Vehicle/Trailer) Parking Brake Control Valves

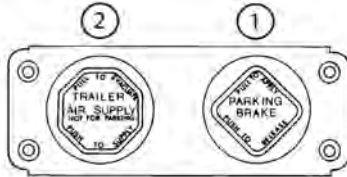

1. Parking Brake Control (Yellow)
2. Trailer Air Supply Control (Red)

**Before You Leave the Cab**

1. Apply all parking brakes. Pull out the **Yellow** Parking Brake Control knob (1) located on the dash. The **Red** (octagon-shaped) Trailer Air Supply Control knob will

automatically pop out. (A dash warning light will indicate when the brake is ON.)

2. Shift the transmission into PARK position:
  - manual transmission, select First or Reverse gear.
  - automatic transmission, select Neutral.
3. Turn the key to OFF.
4. Remove the key.

**WARNING**

Do not pull out the parking brake valve while the vehicle is moving. Stopping with the parking brake controls can cause a sudden wheel lockup, loss of control, or over-take by following vehicles. Failure to comply may result in property damage personal injury, or death.

The parking brakes act on the rear wheels only. They are spring-applied, with air pressure used to release them. Release air is supplied by both the front and rear circuit air tanks through a double check valve.

**To Release the Vehicle Parking Brakes ONLY**

- Push IN the **Yellow** knob on the dash. Your trailer will remain parked.
- Below 60 psi (414 kPa) the **Yellow** parking brake valve remains OUT (ON position). If air pressure is not restored above 60 psi (414 kPa), the knob will automatically return to the OUT position if you attempt to push it in. Check the Primary and Secondary Air Pressures in the Primary Gauges gauge view.

**To Release the Trailer Brakes ONLY**

- Push IN the **Red** knob on the dash. The vehicle will remain parked.

**To Release the Full Combination of Brakes**

- Push IN **BOTH** knobs on the dash.
- In the event that air pressure is reduced below a safe level: the low air warning light will come on first; if air pressure continues to drop, the parking brake valve will pop OUT, automatically applying the spring brakes.



**CAUTION**

Do not try to put the vehicle in motion before pressure in the system reaches 100 psi (689 kPa) because the wheels are locked by the spring brake action. Unnecessary stress and possible brake malfunction could occur if the vehicle is forced to move before the air system reaches 100 psi (689 kPa). Failure to comply may result in equipment damage.



**WARNING**

If the air pressure falls below 60 psi (414 kPa) the spring brakes may stop the vehicle abruptly, which could cause an accident resulting in personal injury or death. Observe the gauges. If the warning alert comes on, do not continue to drive the vehicle until it has been properly repaired or serviced.



**WARNING**

Using the trailer hand brake or air brakes to hold a parked vehicle is dangerous. Because they work with air pressure, these brakes could come loose. Your vehicle could roll, causing an accident involving death or personal injury. Always set the parking brakes. Never rely on the trailer hand brake or truck air brakes to hold a parked vehicle.

**Vehicle/Trailer Air Supply Valve**

**Initial Charge**

The red octagon knob controls the air supply to the trailer. With the system completely discharged, both the **Red** (trailer air supply) and the **Yellow** (parking brake) knobs are OUT; thus, vehicle and the trailer parking (spring) brakes are applied.

To supply air to the trailer system and release the trailer parking brakes:

1. Allow the vehicle air system pressure to build up to operating level.

2. When system pressure reaches 50 psi (345 kPa) the **Red** knob may be pushed IN.
3. Hold the **Red** knob IN by hand until the trailer air pressure builds to a pre-set level, about 45 psi (310 kPa). At this point it will remain in, charging the trailer system and releasing only the trailer brakes.
4. The **Yellow** knob will remain OUT (vehicle brakes ON).

**Normal Run Position**

- The **Yellow** knob (system park) may now be pushed IN, which will supply air to the vehicle spring brakes, releasing them.

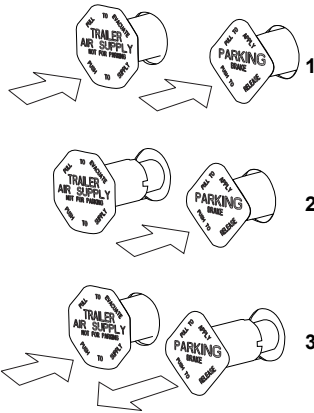

1. Normal Run Position
2. Trailer Park with Vehicle Released
3. System Park or Trailer Charge with Vehicle Parked

### Trailer Park or Emergency Brake Application Only

If you ever have a failure or disconnect the air supply hose to the trailer, the trailer parking brakes will set. The **Red knob** will automatically pop OUT and seal off the vehicle air tanks to protect the vehicle air system pressure.

To apply the trailer brakes only: Pull OUT the **Red knob**. This will exhaust air from the trailer supply line, causing the vehicle protection valve to close and the trailer spring brakes to apply. The trailer is now in emergency or park. This mode would be used to uncouple from the trailer (running without a trailer connected).



### WARNING

Using the trailer hand brake or air brakes to hold a parked vehicle is dangerous. Because they work with air pressure, these brakes could come loose. Your vehicle could roll, causing an accident involving death or personal injury. Always set the parking brakes. Never rely on the trailer hand brake or truck air brakes to hold a parked vehicle.

### System Park

With both knobs pushed in for normal operating modes, the parking brakes of both the vehicle and the trailer may be applied by pulling the **Yellow knob** OUT. This will exhaust the air from the vehicle spring brakes, and simultaneously cause the **Red knob** to pop OUT, which will apply

the trailer brakes. This complies with the Federal Motor Vehicle Safety Standards (FMVSS) 121 requirement that one control should apply all the parking brakes on the vehicle.

### Trailer Charge

If both knobs are OUT (combination vehicle is parked), and it is desired to recharge the trailer, the **Red knob** may be pushed IN repressurizing the trailer supply line. The vehicle will remain parked. For more information on air pressure requirements, see [Initial Charge](#) on page 138.

### Trailer Brake Hand Valve

This hand valve provides air pressure to apply the trailer brakes only. It operates independently of the foot treadle valve.

To operate the trailer brake hand valve:

- Pull down on the lever under the right side of the steering wheel.
- The valve is self-returning. When pressure is removed from the valve lever, it will return to the OFF position.



**NOTE**

The trailer brake is not to be used as a substitute for the service brakes. Using this brake frequently, instead of using the foot brake, will cause the trailer brakes to wear out sooner.



**WARNING**

Using the trailer hand brake or air brakes to hold a parked vehicle is dangerous. Because they work with air pressure, these brakes could come loose. Your vehicle could roll, causing an accident involving death or personal injury. Always set the parking brakes. Never rely on the trailer hand brake or truck air brakes to hold a parked vehicle.

**Brake Components**

The following is a brief description of the air/brake system.

**Compressor:** supplies air to the system. System pressure is controlled by the governor.

**Governor** controls the air pressure in the system by actuating the compressor discharge mechanism. Its cut-out pressure is 115 to 125 psi (793 to 862 kPa). Its preset cut-in pressure is set to between 13 to 25 psi (90 to 172 kPa) below the cut-out pressure setting (cut-out and cut-in interval is not adjustable).

**Safety Valve** installed on the supply air tank outlet. It should vent off at 150 psi (1034 kPa) permitting air to escape.

**Air Dryer** collects and removes moisture and contaminants from the air as it travels from the compressor to the wet tank.

**Compressed Air Tanks** The wet tank receives air from the air dryer and cools it somewhat, allowing moisture to condense for draining. Relatively dry air is then supplied to the two service air tanks for distribution to their respective brake circuits. The service air tanks are isolated from each other by check valves.

**Dual Service Brake Treadle Valve** delivers air to the two service brake circuits.

**Double Check Valve** directs the higher air pressure from either the rear (primary) or front (secondary) service air tank to the modulating valve.

- Limits spring brake hold-off air pressure delivered to the

spring brake chambers.

- Provides a quick release of air pressure from the spring brake chambers to speed spring brake application.
- Modulates spring brake application in proportion to front service application in the event of a rear service failure.
- Prevents compounding of service and spring applications.

**Modulating Valve (SR-1)** used only on full trucks, not tractors, performs four functions:

**Quick-Release Valve** speeds the release of air from the brake chambers. When air is released, the air in the brake chambers is exhausted at the quick-release valve, rather than exhausting back through the treadle valve.

**Single Check Valve** allows air flow in one direction only.

**Parking Brake Valve** Yellow diamond-shaped knob. It controls the application and release of

<b>Trailer Supply Valve</b>	<p>the parking (spring) brakes of the vehicle or of the vehicle-trailer combinations. If the air system is being charged from zero pressure, the parking brake valve will not hold in the release position until the system pressure exceeds 60 psi (414 kPa), which is the pressure required to override the load of this valve's plunger return spring.</p> <p>The Red octagonal-shaped knob protects the vehicle system; it functions in conjunction with the parking brake valve (yellow). The trailer supply valve is responsible for synchronizing the vehicle and trailer parking and emergency brakes. If the air system is being charged from zero pressure, the trailer supply valve will not hold in the applied position until the system pressure exceeds 50 psi (345 kPa). It automatically pops out and exhausts air if supply air pressure drops below 60 psi (414 kPa).</p>
<b>Vehicle Protection Valve</b>	<p>The functions of this valve are to (1) receive all pneumatic signals pertinent to the operation of the trailer brake system, (2) transmit these signals to the trailer, and (3) protect the vehicle air supply in case of separation of the air lines connecting the vehicle to the trailer.</p>

## Brake Safety and Emergency



### WARNING

Do not operate the vehicle in the event of a malfunction in any air circuit. The vehicle should not be operated until the system is repaired and both braking circuits, including all pneumatic and mechanical components, are working properly. Loss of system air can cause the service brakes to not function resulting in the sudden application of the spring brakes causing wheel lock-up, loss of control, or overtake by following vehicles. Failure to comply may result in property damage, personal injury, or death.

- If pressure is lost in the vehicle front or rear circuit, the "check" valves isolate the unaffected circuit, allowing this circuit to continue normal operation. The trailer brakes are still functional.
- If air pressure is lost in the trailer supply/park circuit, and the

pressure drops below 60 psi (414 kPa), the trailer spring brakes are automatically applied, and the vehicle air pressure circuits are unaffected.

- If air pressure is lost in the trailer brake service circuit, and the pressure in the vehicle front and rear circuits drops below 60 psi (414 kPa), the vehicle and trailer spring brakes are automatically applied.

### ABS Warning Lamp

The ABS warning lamp will come on briefly, then go off, when the key switch is first turned on. If the lamp remains ON until a speed of 4 mph (6 km/h) is reached, then goes OFF, there may be a stored fault code. If the lamp remains ON when a speed in excess of 4 mph (6 km/h) is reached, there may be an active fault in the ABS system.



**CAUTION**

If the ABS warning light does not illuminate when the ignition is first turned on, there is a problem with the bulb or wiring. You should have this checked as soon as possible.



**WARNING**

No indication will be given via the dashboard warning lights or buzzer if tires of the wrong size are installed on your vehicle. The Anti-Lock Brake System (ABS) is calibrated for the specific tire revolutions per mile. Use of a tire and/or wheel size different from that originally installed on your vehicle may cause the ABS system to not function during a hard braking event. This could cause an accident or serious personal injury. Consult with your dealer before using a different tire and/or wheel size than was originally installed on your vehicle.

**Automatic Traction Control**



Your truck/tractor ABS is equipped with an automatic traction control (ATC) feature. This feature is controlled by a switch on the dash. Do not allow the traction control lamp to remain on continuously for an extended length of time. Extended continuous use of the ATC can cause overheating of the drive wheel brakes. Engine torque or vehicle speed should be reduced to eliminate wheel spin and prevent excessive application of the ATC system. Except for checking for proper illumination of the ABS and traction control warning lamps when first starting the vehicle, and for monitoring these lamps while driving, no special operating procedures are required. For detailed system description, see literature for your specific ABS that was provided with your vehicle.

**Emergency Braking**



**WARNING**

Unless you have an anti-lock braking system (ABS), always avoid completely depressing the service brake pedal, if possible, even during emergency braking. Depressing the brake pedal too aggressively can cause the wheels to lock, which can lead to an uncontrolled skid and can result in an accident. Failure to comply may result in property damage, personal injury, or death.

For Non-ABS Vehicles:

To stop your vehicle in an emergency, vary the service brake application pressure to provide maximum braking force without locking the wheels. Use engine compression to assist the service brakes by not depressing the clutch pedal until the engine reaches idle speed.

**Brake Warning Lamp**

When the brake warning lamp comes on, it indicates a malfunction in the brake system. Possible malfunctions include loss of hydraulic pressure from the power



steering circuit or a pressure differential between the primary and secondary brake circuits.

**WARNING**

Do not operate the vehicle if the brake light or buzzer comes on. The light or buzzer indicates a failure in one of the brake components/system. Drive your vehicle to the side of the road immediately. Failure to do this may lead to an accident and severe injury.

**SERVICE BRAKE WARNING INDICATOR**

If the buzzer sounds while driving, or if the BRAKE light comes on, do the following:

1. Slow down carefully. Here are some things you can do to assist in slowing the vehicle:
  - Downshift - Putting the transmission into a lower gear will help slow the vehicle.
  - Pump the brakes - Pumping the brake pedal may generate enough hydraulic pressure to stop the vehicle.

- Use the parking brake - The parking or emergency brake is separate from the hydraulic system. Therefore it can be used to slow the vehicle.
2. Move a safe distance off the road and stop.
  3. Set the parking brake.
  4. Turn on the emergency flasher and use other warning devices to alert other motorists.

**Wet Brakes****WARNING**

DO NOT drive through water deep enough to wet brake components, as it may cause the brakes to work less efficiently than normal. The vehicle's stopping distance may be longer than expected, and the vehicle may pull to the left or right when brakes are applied, which could contribute to an accident involving death or personal injury.

If you have been driving in heavy rain or deep standing water, your brakes will get

wet. Water in the brakes can cause them to be weak, to apply unevenly, or to grab. These conditions can cause a lack of braking power, wheel lockups, or pulling of the vehicle to one side or the other. Avoid driving through deep puddles or flowing water if possible. If not possible, you should to the following:

- Slow down.
- Place transmission in lower gear.
- Gently press on the brake pedal.
- Increase engine speed while keeping light pressure on the brake pedal for a short distance to dry out the brake linings.

## Brake Operation



### WARNING

DO NOT drive through water deep enough to wet brake components, as it may cause the brakes to work less efficiently than normal. The vehicle's stopping distance may be longer than expected, and the vehicle may pull to the left or right when brakes are applied, which could contribute to an accident involving death or personal injury.

To rectify this condition, check the rear and both sides of the vehicle for clear traffic, then apply the brakes gently, releasing and gently reapplying until the brakes dry out, restoring normal operation. Always check brakes after driving through deep water to help reduce the possibility of personal injury or an accident.

## Overheated Brakes

Under normal braking conditions, the energy generated will bring the internal brake drum temperature to about 500° F (260° C). This is well within the safe zone: the maximum safe temperature of lining for

drum type brakes is usually about 800° F (427° C).

If service brakes are used for emergency braking, used improperly, or for prolonged periods, internal brake drum temperatures may exceed 800° F (427° C). Such brake overheating may be detected by a burning smell or smoke coming from a drum. If this occurs, you should immediately stop and check for cracked brake drums or lining fires. If neither exists, continue driving and resume a slow speed as soon as possible to cool the brakes. If the vehicle was to remain stopped, the heat transfer could destroy the linings and distort the brake drum.

To prevent drums from distortion while they cool down:

- Park the vehicle on level surface and block the wheels.
- Release the parking brake and allow the brakes to cool down. See [Brakes, Parking Brake Valve](#) on page 88.

## Retarders

Various retarders are available, which function against the engine, driveline, or

transmission. These are devices that use your engine's power to slow down your vehicle. They save wear and tear on your service brakes and can be a safety feature, too, because they can keep your brakes from overheating. Ideally, you should always slow your vehicle with your retarder (where permitted by law) and use your service brakes only for stopping completely. Operating this way will greatly prolong the life of your brakes.



### WARNING

DO NOT use any of the vehicle's retarders in any situation that requires an immediate stop and/or in situations of poor traction (such as wet, icy or snow covered roads). Trying to use the retarder instead of the service brakes may cause a loss of vehicle control, which may result in an accident involving death or personal injury.

**WARNING**

The service brakes must be used in an emergency. The retarder alone might not stop you fast enough to prevent an accident. Failure to comply may result in death, personal injury, equipment or property damage.

The retarder is NOT intended as the primary brake for the vehicle, nor is it an emergency brake. The retarder only helps the service brakes by using pressure to slow the drivetrain. Use the service brakes for quick stops. Do not use the retarder when operating on road surfaces with poor traction (such as wet, icy, or snow covered roads or gravel). Retarders can cause the wheels to skid on a slippery surface. We recommend that you do not use your engine retarder to slow down when you are bobtailing or pulling an empty trailer.

**WARNING**

Using an engine retarder can cause a wheel lockup. The trailer is not loading the tires enough to give the traction

you may need. When you are bobtail or unloaded, you can have a serious accident if your wheels lock suddenly during braking. You could be killed or injured. DO NOT use your retarder when you are driving bobtail or with an unloaded trailer.

This vehicle may have a transmission retarder. Take your foot off the throttle and operate the retarder switch. When you do not need full retarder effect, you can apply it intermittently (off and on) to cause gradual or partial slowing. Continuous application of your retarder will cause your hydraulic fluid to get hotter. Intermittent application will help prevent overheating.

**WARNING**

DO NOT rely on your automatic transmission hydraulic retarder to stop your vehicle. If your engine shuts down, the vehicle's retarder will cease to operate which may lead to an accident involv-

ing death or personal injury. Always be ready to suddenly apply the service brakes.

**NOTE**

The exhaust brake and engine brake are two types of engine retarders. Refer also to the engine manufacturer's Operator Manual and to the Engine Retarder manual for additional instructions.

**Exhaust Brake**

With the exhaust brake switch **ON**, the brake automatically creates its braking effect when you remove your foot from the accelerator pedal.

The brake switch is located on the accessory dash panel. It controls whether the brake is **ON** (ready to slow the vehicle down) or **OFF** (no braking action).

- Do not use the engine retarder (such as an exhaust brake) to slow the vehicle down when you are pulling an empty trailer. See Engine Brakes for further details.



**WARNING**

Using an engine retarder can cause a wheel lockup. The trailer is not loading the tires enough to give the traction you may need. When you are bobtail or unloaded, you can have a serious accident if your wheels lock suddenly during braking. You could be killed or injured. **DO NOT** use your retarder when you are driving bobtail or with an unloaded trailer.

- Make sure the brake is OFF before starting the engine.
- After the engine is started, warmed up, and you are ready to get under way, turn the exhaust brake switch ON for added braking effect.



**WARNING**

**DO NOT** use the vehicle's engine compression brake or exhaust brake in any situation that requires an immediate

stop and/or in situations of poor traction (such as wet, icy, or snow covered roads). Trying to use the engine compression brake or exhaust brake instead of the service brakes may cause a loss of vehicle control, which may result in an accident involving death or personal injury.

If your vehicle is equipped with ABS, the operation of the exhaust brake (if turned ON) will be controlled by the ABS. For further details on how to use the exhaust brake, see the exhaust brake manufacturers Owner's Manual.

**Engine Brakes**

**Engine Brake ON/OFF Switch**



**Engine Brake Level Switch**



Two switches control your vehicle's engine brake. Engine Brake ON/OFF turns on or off engine braking, and Engine Brake Level controls the amount of engine braking that occurs when the engine brake is active. Both switches are located in the right-hand switch panel. With the engine brake switch **ON**, the engine brake automatically creates its braking effect when you remove your foot from the accelerator pedal and becomes active. When engine braking is **ON**, the three-position Engine Brake Level switch determines the amount of engine braking that will occur when activated: Low, Medium, or High.

## Engine Brake Level (3 position)

Switch Position	Amount of Engine Braking
Top	High – 100%
Middle	Medium – 66%
Bottom	Low – 33%

See your Engine Operation and Maintenance Manual or Engine Brake Operation Manual for further details on using engine retarders.

## Engine Brake Indicator



When engine braking is active, this (green) indicator will appear. Vehicles with an engine braking level switch show the degree of engine braking applied using dots below the indicator. Active engine braking can be overridden when the operator or a truck feature (like the Adaptive Cruise Control (ACC) option)

provides acceleration. In these cases, the engine brake indicator will turn white while acceleration is being applied.

## Axle and Suspension

### Differential Lock



The vehicle may be equipped with switches to lock the either of the rear axle differentials. Depending on how the vehicle is specified, a combination of individual switches may be available that can lock the interaxle driveline and/or any combination of the forward rear or rear-rear driving axles. The interaxle differential switch allows each axle to turn independently. In certain situations, engaging the interaxle differential lock relieves stress on the rear axles and reduces tire wear. Engaging this switch will also provide better traction in slippery or loose gravel conditions. In the LOCK position, continuous operation on paved, dry surfaces, put stress on the axles, and can possibly damage the

internal gears. The switch has a guard to prevent accidental operation of the switch. Locking the differentials is typically used during ice or snow conditions and without tire chains, unpaved roads that have loose sand, mud or uneven surfaces. Look ahead and predict when the differential needs to be locked. Stop the vehicle and lock the differentials before approaching. While using the differential in the locked position, do not exceed 25 mph (40 km/h). When disengaging the differential lock, reduce the throttle to prevent drivetrain damage.



### WARNING

DO NOT put the differential lock in the LOCK position while the wheels are spinning freely (slipping), you could lose control of the vehicle or cause axle damage. Switch to LOCK only when the wheels are not spinning. Failure to comply may result in death, personal injury, equipment or property damage.

### Inter-Axle Differential Lock Operation

**i** NOTE

Do not use the differential lock during downhill operation or at speeds above 25 mph (40 km/h). When it is engaged under these conditions, your vehicle will exhibit understeer handling characteristics. This understeer condition will cause your vehicle to not turn as quickly and more steering effort will be required, which can cause an accident. Failure to comply may result in property damage, personal injury, or death.

**Understeer Condition**



1. Turning Radius When Unlocked (Disengaged)
2. Turning Radius When Locked (Engaged)

### To LOCK the Inter-Axle Differential

1. Anticipate when you might need increased traction, slow down to a steady speed under 25 mph (40 km/h) or stop the vehicle. Do not lock the differential while going down steep grades or traveling faster than 25 mph (40 km/h), or while wheels are spinning or traction is minimal; lock the differential before you encounter these conditions.
2. Put the inter-axle differential lock switch in the **LOCK** position. A light on the switch will turn on, indicating that the differential is locked (engaged).
3. If you **LOCK** or **UNLOCK** the differential while moving, let up momentarily on the accelerator pedal to relieve torque on the gearing and allow full engagement of the clutch (mechanism that locks the wheels).

**i** NOTE

The Meritor main differential lock or Dana Spicer wheel differential lock is controlled by the switch labeled

**WHEEL DIFFERENTIAL.** By moving the switch you can **LOCK** or **UNLOCK** the main differential when the vehicle is moving or stopped.

**i** NOTE

If your vehicle has an automatic transmission, it may be necessary to shift the transmission to the Neutral position momentarily to allow the main differential lock splines to fully engage or disengage.

4. Drive the vehicle through the poor traction area, keeping your speed under 25 mph (40 km/h).

### To UNLOCK the Inter-Axle Differential

1. When you reach dry pavement or better road conditions where the differential lock is not needed, switch the differential lock to **UNLOCK**.
2. Let up momentarily on the accelerator pedal to relieve torque and allow the clutch to disengage.
3. When you unlock the differential, normal vehicle handling will

resume and the light on the switch will turn off.

### Driver Controlled Main Differential Lock

If your vehicle has a Meritor axle with a Driver Controlled Main Differential Lock, install the caging bolt before removing the axles for towing. Installation of the caging bolt prevents damage by locking internal axle components in position. Use the procedure below to lock the Meritor differential.

#### Driver Controlled Main Differential Lock

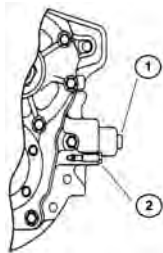

1. Air Line - Remove to Install Caging Bolt
2. Caging Bolt Storage Location
1. Remove the air line.

2. Remove the caging bolt from its storage hole.
3. Screw the caging bolt all the way into the air line hole. This locks the differential by pushing a piston into lock position.

### Dual Range (Two-Speed) Rear Axle



Your vehicle may be equipped with a two-speed or dual range axle (option). The low range provides maximum torque for hauling heavy loads or traveling over rough terrain. The high range is a faster ratio for highway speeds and general over-the-road conditions. A switch on the accessory switch panel controls the dual range rear axle. You will notice that the switch has a guard to protect you from activating it accidentally. Always park your vehicle with the range selector in LOW.

Important tips on operating a dual range axle with inter-axle differential:

- Shift the axle with the inter-axle differential in the unlocked position only.

- When you are driving with poor traction, lock the differential. When you have the differential locked, drive with the axle in LOW range only.
- When you are driving on a surface with good traction, keep the inter-axle differential unlocked. You can drive with the axle in the LOW or HIGH range.
- Always UNLOCK the inter-axle differential before shifting the axle speed range.



#### WARNING

Never shift the axle when moving downhill. Engine driveline disengagement may occur, eliminating engine retardation and allowing the wheels to spin faster than the current speed of the engine. This may require severe braking to slow the vehicle down and can result in an accident. Failure to comply may result in death, personal injury, equipment or property damage.

**CAUTION**

If you shift the axle range with the inter-axle differential in LOCK, you could seriously damage the axles. Never shift the axle range with the differential locked.

**CAUTION**

To avoid damaging your vehicle shift the axle at slower travel speeds until you are used to driving with a dual range axle.

4

Proper shifting of the axle depends on the synchronization of engine/driveline and wheel speed. When you shift the axle, the connection between the engine and wheels is momentarily disengaged while the gearing is synchronized. Normally when the axle is shifted the speed of the engine, axle, and wheels adjust, allowing for proper gear engagement.

When going downhill the wheels will not slow down, but will tend to speed up, which makes gear synchronization almost impossible. As a result, the axle is neither in HIGH nor LOW range and all engine/driveline retardation is lost. Without engine retardation it is more difficult to slow the vehicle down and greater stress is put on the brake system.

**How to Operate Two-Speed Axle - Low to High**

These steps should be used if operating a two-speed axle in LOW range on rough terrain and preparing to drive on an improved surface.

When you go from rough terrain to highway driving, shift the axle to the HIGH range following this procedure:

1. Be sure the differential is UNLOCKED.
2. Maintain your vehicle speed (accelerator depressed) and move the Range Selector lever to HIGH.
3. Keep driving with the accelerator depressed until you want the axle to shift.
4. To make the axle shift, release the accelerator until the axle shifts. You are now in the HIGH axle range for highway speeds. Shift the

transmission normally to reach your desired cruising speed.

**How to Operate Two-Speed Axle - High to Low**

These steps should be used if operating a two-speed axle in HIGH range on improved roads and preparing to drive on rough terrain.

When you go from highway driving to rough terrain, shift the axle to the LOW range following this procedure:

1. Maintain vehicle speed (accelerator depressed) and move the Range Selector lever to LOW.
2. Keep driving with the accelerator depressed until you want the axle to downshift.
3. To make the axle downshift, release and depress the accelerator quickly to increase the engine rpm. The axle will shift to LOW range.
4. You are now in the LOW axle range for rough terrain and heavy loads. Shift the transmission normally to maintain the desired speed.



## Auxiliary Axle

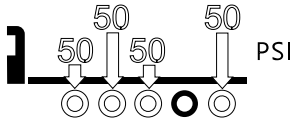

Adjustable auxiliary axles (commonly known as Pusher or Tag axles) can add to the productivity of the vehicle by increasing the load capabilities of the vehicle when they are in the deployed (down) position. There are different configurations of axles with different functionality (liftable versus steerable). Without the extra axle, the excessive weight can reduce the service life of vehicle components such as, but not limited to, the frame rail, axles, suspension and brakes.

Operation of the auxiliary axles includes the proper maintenance of the system and calibration of its controls. Operating the auxiliary axles will also require a firm understanding of the Gross Axle Weight Rating (GAWR) and the load that is being carried.

The vehicle will have switches on the dash to control the position of the auxiliary axles. In certain situations, however, the system will override the controls to protect the axle system. For Self Steering Lift Axles, the

axle will raise when the park brakes are applied or if the vehicle is placed in reverse. For Non-Steer Lift Axles, the axle will only automatically raise if the park brakes are applied and there are no park brakes on the lift axle. Non-Steer Lift Axles do not automatically raise when the vehicle is placed in reverse.

Operating the auxiliary liftable axles must be performed in a manner that does not exceed the axle creep rating. Axle creep ratings are weight and speed limits that are allowed while the vehicle is fully loaded (in excess of the vehicle's standard GAWR) and the axle is in its up position. Axle creep ratings are assigned by the axle manufacturer and are based on axle model and intended service of the vehicle.

Contact an authorized dealership if you are unable to identify the axle creep rating of this vehicle.

- Liftable/steerable (axle lift calibration required)
- Liftable/non-steerable (axle lift calibration required)
- Non-liftable (some suspensions require dump valve calibration)



### WARNING

DO NOT operate or park the vehicle with auxiliary axles in the down/loaded position when vehicle is unladen, or is being unloaded. Raise or dump air into driver controlled auxiliary axle(s) prior to unloading vehicle. Failure to do so can result in loss of vehicle control or roll-away that may result in personal injury, property damage or death.

### Auxiliary Axle Pressure Regulator

Vehicles with liftable auxiliary axles will have knobs available to adjust the pressure in the auxiliary axle suspension. These knobs are in addition to the tag and pusher axle switches that control the axle position.

Adding more pressure to the auxiliary axle will increase the pressure the auxiliary axle pushes down. Increasing pressure will decrease load on the drive axles and will decrease traction. Decreasing pressure will transfer more weight to the drive axles and will result in more traction from the drive axles.

Deflate the auxiliary axle suspension before coupling or uncoupling a trailer.

After the trailer is coupled or uncoupled, then increase pressure to balance traction and axle load requirements. Inflate air springs of the auxiliary axles to the desired pressure after coupling to a loaded trailer while still maintaining proper traction of the drive axles.

Adjust the pressure regulator control knob to a lower pressure until desired traction is obtained. By reducing air pressure at pusher or tag axle, load will be transferred to drive axles. Do not overload drive axles. Always deflate air springs of the auxiliary axles before attempting to unload vehicle. This allows maximum traction of the drive axles to control the vehicle.

Depending on the suspension, various calibrations may be required. Contact your authorized dealer or axle/suspension manufacturer for specific calibration procedures.

Some suspensions require dump valve calibration. For example, some dead axles do not lift, but the air can be dumped out of them to unload them when empty. Air pressure is controlled via an adjustable regulator. These axles need to be calibrated for load.

Contact your authorized dealer or axle/suspension manufacturer for dump valve calibration procedures.

**Axle Creep Rating**

Vehicles outfitted with auxiliary axles and full truck configuration will have an axle creep rating which defines how much load is allowed when the vehicle has a full load and maneuvering the vehicle, at very slow speeds, with auxiliary axles in the up position. In these situations, the load exceeds the gross axle weight rating of the axles.

Operator's using vehicles equipped with liftable auxiliary axles must consider creep ratings when any liftable axle is unloaded or in the raised position. Liftable auxiliary axles should only be raised (or unloaded) to improve maneuverability in an off-road use or when vehicle is unloaded.



**WARNING**

NEVER operate the vehicle with more pressure in the lift axles than is necessary to carry the load, as determined by the calibration procedure described. Failure to do so can result in loss of traction and stability at the steer and/or drive axles and can result in increased braking distance, which could cause loss of vehicle control resulting in an accident. Failure to comply may result

in death, personal injury, equipment or property damage.



**NOTE**

Axle Creep ratings MUST NOT be exceeded.



**CAUTION**

Always lower the axles as soon as possible after receiving a load. Never exceed 5 mph (8 km/h) when driving with a load with the auxiliary axle(s) raised/unloaded. Failure to lower the axle(s) can overload the frame and remaining axles, and could cause equipment damage.

**CAUTION**

DO NOT modify the air system and/or control functionality on a factory installed auxiliary axle(s). Modifying the factory operation of the pusher and/or tag axle(s) will void your warranty, and can cause equipment damage.

**CAUTION**

A change in tire size on either the auxiliary axles or the drive/steer axles can change the calibration of the auxiliary axles. If tires are installed with a different loaded radius, the calibration procedure must be repeated. Failure to do so can cause equipment damage.

Contact your dealer or axle manufacturer to determine what the creep rating is for your particular axle(s) and configuration. Creep ratings are generally limited to the following:

- Tandem rear axles only
- Straight trucks only
- Maximum spring mount centers per axle manufacturers specifications

- Maximum tire static loaded radius (SLR) per axle manufacturers specifications

### Pusher or Tag Suspension Calibration

Perform this procedure at or near a weight scale. Procedure can be performed while parked on the weight scale if scale is available. To obtain the desired axle load distribution, you must correlate the suspension air gauge pressure to the actual axle load by scaling the axle weight(s) and adjusting the pressure to obtain the desired load. Once the desired load or load range is achieved, document the pressure-to-load ratio or setting for future use.

**NOTE**

This procedure must be performed prior to placing the vehicle into service.

Add: Perform this procedure at or near a weight scale. Procedure can be performed while parked on the weight scale if scale is available.

**Setting the Pressure-to-Load Ratio**

To obtain the desired axle load distribution, you must correlate the suspension air gauge pressure to the actual axle load by scaling the axle weight(s) and adjusting the pressure to obtain the desired load. Once the desired load or load range is achieved, document the pressure-to-load ratio or setting for future use.

These instructions are general in nature. For more specific instructions, review the pusher or tag suspension manufacturers maintenance manual or contact the nearest authorized dealer.

1. Park the loaded vehicle on a level surface with the wheels blocked.
2. Release vehicles spring brakes. (Do not release for Lifiable/Non-Steerable pusher or tag axles)
3. Lower the pusher/tag axles with the **Axle Lift Control** flip valve. (For some non-lifiable axles, inflate air suspension)
4. Adjust the amount of load on each axle by turning the **Pressure Regulator** clockwise to increase the load, or counterclockwise to decrease the load. (The suspension manufacturer may publish pre-established Pressure-to-Load Ratio Pressure Settings to

assist you in achieving an estimated ground load).

- After setting the pressure to obtain the desired axle load, verify proper ground loading with the weight scale.

**i** NOTE

Exceeding local, state, or federal weight limits may result in citations. Contact your local commercial weight enforcement office for limits in your area.

**i** NOTE

Steerable-pusher and/or tag axle(s) will raise when the transmission is shifted into reverse or when the parking brakes are applied.

### Air Suspension Ride Height

Vehicles equipped with rear or front air suspensions have their ride height and axle (pinion) angle(s) preset at the factory. These are precision settings and should not be altered. Incorrectly adjusted ride

height may result in improper interaxle U-joint working angles. This can result in premature driveline wear and driveline vibration.

If it becomes necessary to reset the ride height, you may temporarily set it by following the next procedure. Proper ride height measurement and values are shown in the illustration and table below.

**⚠ CAUTION**

Completing this procedure will enable you to safely reach the nearest authorized dealer or repair facility to have ride height and pinion angle reset using the proper equipment and technique. Do this as soon as possible to avoid potential driveline damage.

**i** NOTE

Suitable wheel chocks are at a minimum an 18-inch (46 cm) long 4x4.

- Park the vehicle, engage the parking brakes and clock the wheels.

- Locate the air suspension ride height valve.

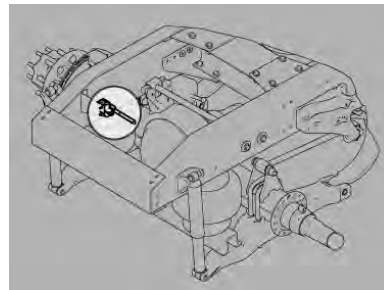

- Ensure that the tractor is fully laden during this procedure. Do not use these procedures on a vehicle that is not laden (bobtail).
- Ensure the air supply and delivery plumbing of the height control valve is consistent with the following illustrations.
- Loosen the fasteners mounting the height control valve to its bracket.

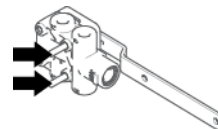

6. Rotate the valve either clockwise or counterclockwise until air pressure in the air springs provides the ride height specified for that suspension. Measure the ride height from the bottom of the frame rail to the approximate centerline of the rearmost drive axle hub:
  - For tandem axles, make the vertical measurement at the centerline of the suspension.
  - For a single axle, make the measurement in front of the axle, in the area forward of the tires but not past the suspension bracket.
7. When at the correct ride height, ensure that the height control valve lever is in the neutral position, then install either the built-in alignment pin or a 1/8 in. (3 mm) dowel.

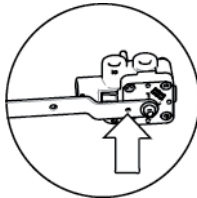

8. Torque the mounting fasteners to 55-75 lb-in. (6.2-8.5 N·m).
9. Remove the alignment pin or dowel.
10. Repeat Steps 2 through 6 above for the right-hand valve on vehicles with a dual-valve system.

### Air Ride Height Data

These are factory settings for ride height of the rear air suspension.

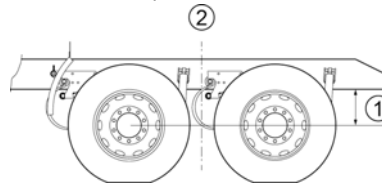

1. Ride height
2. Centerline of suspension

Single Axle	Laden Ride Height -in. (mm)
Air Trac	11.00 (279)
Low Air Leaf	6.50 (165)

Single Axle	Unladen Ride Height -in. (mm)
Air Trac	11.39 (289)
Low Air Leaf	6.75 (171)

Tandem Axle	Laden Ride Height -in. (mm)
Air Leaf	11.70 (297)
Air Trac	11.00 (279)
Low Air Leaf	8.50 (216)
Low Low Air Leaf	6.50 (165)
FLEX Air	8.50 (216)

Tandem Axle	Unladen Ride Height -in. (mm)
Air Leaf	12.0 (305)
Air Trac	11.38 (289)
Low Air Leaf	8.75 (222)
Low Low Air Leaf	6.75 (171)
FLEX Air	8.75 (222)

## Suspension Air Pressure Gauge & Switch

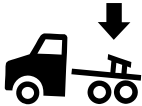

Your vehicle may have an air suspension and a deflation switch which allows the air in the suspension to be exhausted from a switch on the dash. The normal purpose of this feature is to allow you to lower the vehicle for loading. A guard on the switch prevents you from accidentally deflating the suspension.

The Suspension Air Pressure gauge (optional) indicates the amount of air pressure in the air suspension springs in pounds per square inch (psi). Air pressure in the spring is related to the rear axle load. The greater the rear axle load, the greater the air pressure in the air bags. Therefore, the air pressure displayed will vary, depending upon the rear axle load.

## What to do if an Air Spring Ruptures

If an air spring has ruptured, drive the vehicle to a safe stop off the highway to investigate the problem.



### WARNING

DO NOT continue to drive with ruptured air springs. The air loss can cause the spring brakes to apply allowing your brakes to drag and burn up the linings, which could lead to an accident causing death or personal injury. DO NOT continue to operate the vehicle in this condition.



### WARNING

DO NOT drive the vehicle if the air pressure is less than 100 psi (690 kPa). Driving the vehicle with less than 100 psi (690 kPa) could make the brakes unsafe to use which could cause an accident involving death or personal injury.



### CAUTION

Operating a vehicle with air suspension bags either overinflated or underinflated may cause damage to drive-line components. If a vehicle must be operated under such conditions, do not exceed 5 mph (8 km/h). Failure to comply may result in equipment damage.

You can get to a repair facility by removing the height control link connected to the axle and to the suspension air valve control arm. This will cause the air valve control arm to center in the closed position. Removing the link will allow the air system of the truck to operate normally so that the vehicle can be driven to a service center.

## Fifth Wheel

The following applies to tractor configurations:

**WARNING**

Ensure that all fifth wheel maintenance, adjustments, and rebuilding are done only by a qualified mechanic. An improperly maintained fifth wheel can cause a trailer to separate from a tractor. This could lead to a serious accident. Failure to comply may result in property damage, personal injury, or death.

Your vehicle is equipped with either a Fixed or an Air-Controlled Sliding Fifth Wheel. Either type should self lock when a trailer king pin trips the locking dogs as the tractor is backed under a trailer.

**How to Lock the Kingpin**

Ensure that the fifth wheel lock is in the unlocked position.

**WARNING**

Always inspect the fifth wheel for proper locking after coupling the tractor to a trailer. Failure to properly couple the

tractor to a trailer (the kingpin is engaged in a closed lock jaw with the lock jaw secured by a closed plunger) may cause trailer separation which could result in an accident involving death or personal injury.

To lock the fifth wheel around the kingpin:

1. Ensure trailer brakes are locked and the landing gear is down.
2. Back the tractor fifth wheel into the trailer kingpin to engage and lock.

**JOST Fifth Wheel Indication**

*If equipped with JOST fifth wheel*

3. Pull the tractor forward to ensure the kingpin has been locked in place.
4. Set the tractor parking brake.
5. Connect the tractor brake air and electric lines to the trailer.

Conduct a pre-trip inspection prior to releasing the brakes, raising the landing gear, and driving the vehicle.

**How to Release the Kingpin Remotely (option)****CAUTION**

Do not deflate the rear suspension before unlocking the fifth wheel. Deflating the rear suspension before unlocking the fifth wheel could cause difficulty during uncoupling and result in damage to the fifth wheel and kingpin.

1. Set both the vehicle and trailer parking brakes.
2. Lower the landing gear.
3. Disconnect the tractor brake air and electric lines from the trailer.
4. Flip up cover, then press and hold the **Kingpin Release** switch for 3 seconds. A countdown timer popup will appear on the display, and the unlock symbol on the **Kingpin Release** switch will illuminate.

The popup will inform the operator when to release the switch.

**JOST Fifth Wheel Indication**



*If equipped with JOST Fifth Wheel*

**i** NOTE

The fifth wheel will not unlock unless the vehicle is stopped and the parking brake is set. In this situation, a red-colored popup appears, informing the operator that kingpin release is not available and to set the parking brake. This will require restarting this procedure.

5. Release the switch. The unlock symbol on the **Kingpin Release** switch will turn off.
6. Ease tractor forward enough for the kingpin to clear the fifth wheel (about 12 to 18 inches).

**i** NOTE

Do not drive tractor free of trailer.

7. If the tractor has a rear air suspension, deflate (dump) the rear suspension enough so that the fifth wheel will smoothly separate from the trailer.

**Suspension Dump Symbol**

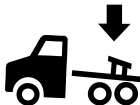

8. Ease tractor forward, clearing the trailer.
9. If the rear suspension was deflated, return rear suspension to its normal height.

**How to Release the Kingpin Manually**

**⚠ CAUTION**

Do not deflate the rear suspension before unlocking the fifth wheel. Deflating the rear suspension before unlocking the fifth wheel could cause difficulty during uncoupling and result in damage to the fifth wheel and kingpin.

**i** NOTE

The specific method required to operate the fifth wheel release handle will depend on the fifth wheel manufacturer and model. The operator should be familiar with this method prior to attempting this procedure.

To release the kingpin and separate tractor from trailer

1. Position the tractor and trailer in a straight line on firm, level ground.
2. Set both the tractor and trailer parking brakes.
3. Exit cab and lower the trailer landing gear.



4. Disconnect brake air and electric lines from trailer, and secure lines.
5. Unlock the fifth wheel release handle if necessary, then unlock the fifth wheel.

**NOTE**

Operating the release handle and unlocking the fifth wheel will depend on the fifth wheel manufacturer.

6. Return to cab and release tractor parking brake.
7. Ease tractor forward enough for the kingpin to clear the fifth wheel (about 12 to 18 inches).

**NOTE**

Do not drive tractor free of trailer.

8. If the tractor has a rear air suspension, deflate (dump) the rear suspension enough so that the fifth wheel will smoothly separate from the trailer.

**Suspension Dump Symbol**

9. Ease tractor forward, clearing the trailer.
10. If the rear suspension was deflated, return rear suspension to its normal height.

**Air-Controlled Sliding Fifth Wheel (option)**

Vehicles that have an air-controlled sliding fifth wheel have a fifth wheel slider lock controlled by a switch on the accessory switch panel. To operate this type of lock, move the switch to the appropriate position. By placing the switch in the **UNLOCK** position, you can slide the fifth wheel to various positions to adjust weight distribution. There is a guard on this switch to protect you against accidentally activating or releasing the lock.

**WARNING**

Do not move the fifth wheel while the tractor-trailer is in motion. Your load could shift suddenly, causing you to lose control of the vehicle, which can result in an accident. Never operate the vehicle with the switch in the **UNLOCK** position. Always inspect the fifth wheel after you lock the switch to be sure the fifth wheel lock is engaged. Failure to comply may result in property damage, personal injury, or death.

**How to Slide the Fifth Wheel**



**WARNING**

DO NOT move the fifth wheel while the tractor-trailer is in motion. Your load could shift suddenly, causing you to lose control of the vehicle. Never operate the vehicle with the switch in the UNLOCK position. Always inspect the fifth wheel after you lock the switch to be sure the fifth wheel slide lock is engaged. Failure to comply may result in death, personal injury, equipment or property damage.



**WARNING**

Do not attempt to slide the fifth wheel until all persons and obstacles are clear of the vehicle.



**NOTE**

This procedure assumes a connected trailer. The trailer kingpin must be locked within the fifth wheel when changing slide positions.

1. Position the tractor and trailer in a straight line on firm, level ground.
2. Place the tractor in neutral, and set the tractor and trailer parking brakes.
3. Unlock the slide by repositioning the Fifth Wheel Slide switch.



**CAUTION**

Ensure the tractor and trailer brakes are engaged prior to sliding the fifth wheel. Failure to engage the brakes could result in uncontrolled sliding of the fifth wheel and possibly damage components on the tractor or trailer.

Fifth Wheel Slide Symbol



4. Inspect and verify that locking plungers have fully withdrawn from the fifth wheel slide tracks.
  - a. If locking plungers did not fully withdraw, move tractor slightly to reposition plungers and reinspect.

- b. If plungers are still not fully withdrawn, lower the landing gear and deflate the rear suspension (if available) to lessen pressure on the slide.

Suspension Dump Symbol



5. Release the tractor parking brake, but keep the trailer brakes engaged.
6. Slowly ease tractor forward or backward, and stop at the desired position.
7. Lock the slide by returning the Fifth Wheel Slide switch to its previous position.
8. Inspect and verify that the locking plungers are fully inserted into the fifth wheel slide tracks.
  - a. If the locking plungers are not fully inserted in the track, move the tractor slightly to reposition plungers and reinspect.

**WARNING**

Do not operate the vehicle unless the locking plungers are fully inserted into the fifth wheel slide track. Operating the vehicle while the plungers are not fully inserted could lead to the slide moving unexpectedly, resulting in a loss of vehicle control and potentially causing property damage, serious injury, or death.

9. If the landing gear was lowered, raise the landing gear.
10. If the rear suspension was deflated, return rear suspension to its normal height.

**Fifth Wheel Lubrication**

Frequently operate and lubricate movable or sliding fifth wheels to prevent corrosion.

**CAUTION**

Both the fifth wheel plate and the slide tracks (if a slider) should be cleaned

and lubricated periodically to ensure smooth turning and sliding action. Failure to keep these surfaces lubricated can lead to frame or driveline damage.

For maintenance information see [Fifth Wheel Monthly Maintenance](#) on page 251, [Fifth Wheel Bi-Annual Maintenance](#) on page 251 and [Sliding Fifth Wheels](#) on page 252.

**Driving Tips and Techniques**

This section covers additional driving tips and techniques on how to drive your vehicle more efficiently.

**Coasting****WARNING**

DO NOT coast with the transmission in neutral or with the clutch pedal depressed, it is a dangerous practice. Coasting in neutral may result in damage to your drivetrain when you try to re-engage the transmission. You could

lose control of the vehicle which can lead to an accident involving death or personal injury.

Do not coast with the transmission in neutral or with the clutch pedal depressed. Besides being illegal and dangerous, coasting is also expensive. It causes premature failure or damage to the clutch and transmission and overloads the brake system. Coasting with the transmission in neutral also prevents proper transmission component lubrication. During coasting the transmission is driven by the rear wheels, and the countershaft gear (which lubricates the transmission components by oil splash) will only be turning at idle speed.

### Descending a Grade



#### WARNING

DO NOT hold the brake pedal down too long or too often while going down a steep or long grade. This could cause the brakes to overheat and reduce their effectiveness. As a result, the vehicle will not slow down at the usual rate. To reduce the risk of an accident which could cause death or personal injury, before going down a steep or long grade, reduce speed and shift the transmission into a lower gear to help control your vehicle speed. Failure to follow procedures for proper downhill operation could result in loss of vehicle control.

### Engine Overspeed



#### CAUTION

To avoid engine damage, do not let the engine rpm go beyond the maximum governed rpm. Engine damage may result if overspeed conditions occur.



#### NOTE

Often these recommendations are secondary to maintaining an adequate and safe speed relative to the surrounding traffic and road conditions.

Operate the engine within the optimum engine rpm range and do not allow the rpm to exceed the maximum governed speed. See your Engine Operation and Maintenance manual for information regarding engine rpm. When the engine is used as a brake to control vehicle speed (e.g., while driving down a grade), do not allow the engine rpm to exceed maximum governed speed. Under normal load and road conditions operate the engine in the lower end of the range.

The tachometer is an instrument that aids in obtaining the best performance of the engine and manual transmission, serving as a guide for shifting gears. Refer to the Engine Operation and Maintenance manual for optimum engine rpm.

- If the engine rpm moves beyond the maximum governed speed, indicating an overspeed condition, apply the service brake or shift to a

higher gear to bring engine rpm within the optimum speed range.

- When driving downhill: shift to a lower gear, use the engine brake (if so equipped), and use the service brake, keeping the engine speed below 2,100 rpm.

When the engine speed reaches its maximum governed speed, the injection pump governor cuts off fuel to the engine. However, the governor has no control over the engine rpm when it is being driven by the vehicle's transmission, for example, on steep downgrades. Apply service brakes or shift to a higher gear. Fuel economy and engine performance are also directly related to driving habits:

- The best results in trip time and fuel economy are obtained while driving the vehicle at a steady speed.
- Shift into higher or lower gears (or apply the service brake) to keep engine rpm near the lower end of the optimum operating range.
- Avoid rapid acceleration and braking.

**WARNING**

DO NOT look at the Instrument Cluster Display for prolonged periods while the vehicle is moving. Only glance at the monitor briefly while driving. Failure to do so can result in the driver not being attentive to the vehicle's road position or situation, which could lead to an accident and possible death, personal injury, or equipment damage.

The digital display provides information to help the driver optimize vehicle efficiency. See [Trip Summary](#) on page 75 for more information. A driver will find the section describing Trip Information and the rpm detail useful.

**Fuel Consumption**

The vehicle's fuel consumption is connected to five important factors: maintenance, driving habits, general condition of the road, traffic conditions, and vehicle load.

Proper maintenance will keep the vehicle running like new even after long periods of use. The driver must perform the daily and weekly checks of the vehicle.

Maintenance factors affecting fuel consumption:

- Air and/or fuel filters partially clogged
- Engine valves out of adjustment
- Injection pump improperly synchronized
- Injection nozzles defective or uncalibrated
- Improperly inflated tires
- Wheel bearings improperly adjusted
- Clutch improperly adjusted or worn (slipping)
- Fuel leaks

Wrong driving habits must be corrected and the recommendations on economic driving should be followed. Driving factors affecting fuel consumption:

- Excessive speed and unnecessary fast acceleration
- Long periods of idling
- Driving with foot resting on the (manual transmission) clutch pedal

**General Condition**

Other factors affecting fuel consumption are related to loads and the type of roads on which the vehicle operates. It is not

always possible to choose the most adequate road, but the ideal road is the one that allows a steady speed in high gear, without requiring frequent braking and acceleration. The following general conditions can affect fuel consumption:

- Overload
- Unbalanced load
- Very high load
- Inadequate roads
- Traffic conditions

**Stopping the Vehicle**

A hot engine stores a great amount of heat. It doesn't cool down immediately after you shut it off. Always cool your engine down before shutting it off. You will greatly increase its service life.

Idle the engine at 1,000 rpm for five minutes. Then low idle for 30 seconds before shutdown. This will allow circulating coolant and lubricating oil to carry away heat from the cylinder head, valves, pistons, cylinder liners, turbocharger, and bearings. This way you can prevent serious engine damage that may result from uneven cooling.

## Turbocharger

This cooling-down practice is especially important on a turbocharged engine. The turbocharger contains bearings and seals that are subjected to hot exhaust gases. While the engine is operating, heat is carried away by circulating oil. If you stop the engine suddenly, the temperature of the turbocharger could rise as much as 100°F (55°C) above the temperature reached during operation. A sudden rise in temperature like this could cause the bearings to seize or the oil seals to loosen.

## Refueling

Air space in your fuel tanks allows water to condense there. To prevent this condensation while you are stopped, fill your tanks to 95 percent of capacity. When refueling, add approximately the same amount to each fuel tank on vehicles with more than one tank.



### WARNING

DO NOT carry additional fuel containers in your vehicle. Fuel containers, either full or empty, may leak, explode, and cause or feed a fire. Failure to

comply may result in death or personal injury.



### WARNING

Diesel fuel in the presence of an ignition source could cause an explosion. A mixture of gasoline or alcohol with diesel fuel increases this risk of explosion. DO NOT remove a fuel tank cap near an open flame. Use only the fuel and/or additives recommended for your engine. Failure to comply may result in death, personal injury, equipment or property damage.



### CAUTION

Use only Ultra Low Sulfur Diesel (ULSD) Fuel, as recommended by engine manufacturers. If you need further information on fuel specifications, consult the Engine Operation and Maintenance Manual.

If your vehicle is equipped with fuel shut off valves for the take-off and return lines, they are located on the fuel lines entering the

top of the fuel tank. Fuel shut off valves for the fuel crossover line are on the bottom of the fuel tank, at the crossover line connection.

## Final Stopping Procedures

Your vehicle will be easier to start driving when you are ready, and it will be safer for anyone who might be around it. Please remember, too, that in some states it is illegal to leave the engine running and the vehicle unattended.



### WARNING

Using the trailer hand brake or air brakes to hold a parked vehicle is dangerous. Because they work with air pressure, these brakes could come loose. Your vehicle could roll, causing an accident involving death or personal injury. Always set the parking brakes. Never rely on the trailer hand brake or truck air brakes to hold a parked vehicle.

**WARNING**

Lift axles that are not equipped with parking brakes should be fully raised when parking the vehicle. Lift axles, that are not equipped with parking brakes, left in the down position while parked, in certain cases, could cause the parked vehicle to roll, causing an accident involving death or personal injury.

1. Set the parking brake before leaving the driver's seat. To hold your vehicle while it is parked, DO NOT rely on:
  - Air Brakes
  - Hand Control Valve for Trailer Brakes
  - Engine Compression
2. If you are parked on a steep grade, block the wheels.

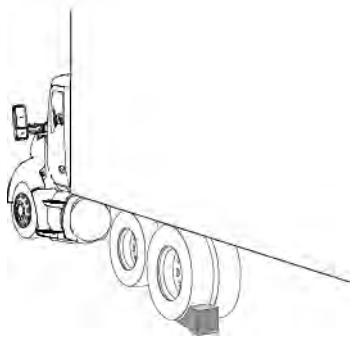

3. Drain water from the air reservoirs. While the engine and air supply system are still warm, drain moisture from the air reservoirs. Open the reservoir drains just enough to drain the moisture. Don't deplete the entire air supply. Be sure to close the drains before leaving the vehicle.

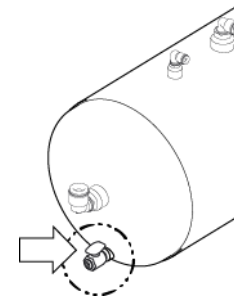

4. Secure the vehicle. Close all the windows and lock all the doors.

## Antilock Brake Systems (ABS)

This vehicle may be equipped with an ABS, which reduces the possibility of wheel lock-up. If a wheel is about to lock during braking, the ABS will automatically adjust air pressure to the brake chambers on the appropriate wheel(s) to prevent wheel lock-up. The ABS is automatically turned on when the ignition switch is turned on.



**WARNING**

The antilock brake system is a critical vehicle safety system. For the safety of you and others around you, have the vehicle submitted for periodic preventive maintenance checks as well as having any suspected problems immediately checked by an authorized dealer. Failure to properly maintain your brake system can lead to serious accidents. Failure to comply may result in property damage, personal injury, or death.



**WARNING**

DO NOT rely on an antilock brake system that is functioning improperly. You could lose control of the vehicle resulting in a severe accident, causing personal injury or death. If your ABS lamp goes on while you are driving or stays on after the self-check, your anti-lock system might not be working. The ABS may not function in an emergency. You will still have conventional brakes, but not antilock brakes. If the lamp indi-

cates a problem, have the ABS checked.

Vehicles without ABS are typically equipped with a bobtail brake proportioning system. When a trailer is not connected, the drive axle brake application pressure will automatically be limited by the proportioning system. When driven in a bobtail mode, these tractors will require greater brake pedal application to provide the equivalent braking to a bobtail tractor not equipped with a proportioning system.

**Trailer ABS Power Line Communication (PLC)**

North American on-highway vehicles are equipped with a separate electrical circuit to power the ABS on towed vehicle(s). In most cases, the ABS power will be supplied through the Auxiliary circuit on the primary 7-way trailer light line connector. If the vehicle was manufactured with a switchable Auxiliary circuit for trailer accessories, an additional 7-way connector would have been provided for trailer ABS power. In either case, the ABS power line on the vehicle will be PLC equipped.



**CAUTION**

DO NOT splice into the non-switchable Auxiliary circuit on the primary 7-way trailer light line. Doing so may cause the trailer ABS to malfunction. This circuit is dedicated for trailer ABS power. To add a switchable auxiliary circuit, contact a dealership.



**NOTE**

Tractors/Trucks and trailers built after 03/01/2001 must be able to turn on an In-Cab Trailer ABS Warning Light (per U.S. FMVSS121). The industry chose Power Line Communication (PLC) as the standard method to turn it on. On trailers built prior to 03/01/2001 verify trailer ABS system status via the required external warning light mounted on the trailer. The indicator light on the trailer should be yellow and identified with the letters ABS.

For doubles or triples, the lamp does not distinguish between trailers. An ABS



problem in any of the trailers will activate the Trailer ABS Warning Lamp. If you change the intended service in any way (e.g., number of axles, multiple trailers, add switchable trailer accessories, etc.) from the date the vehicle was manufactured, you should contact your trailer manufacturer and/or trailer antilock brake manufacturer to determine if the power available at the 7-way trailer light line is adequate. Failure to do so might result in insufficient power to the trailer ABS system, which may affect its operation.



### CAUTION

The center pin of the 7-way trailer light line may be constantly powered for ABS. Make sure it will not accidentally turn on trailer equipment.

### Special Trailer ABS Without PLC (Option)

If a trailer does not have PLC, but it does have ABS that is powered through an optional second trailer connector (ISO 3731) and that trailer ABS is designed to control the Trailer ABS Warning Lamp in the cab and the vehicle has been ordered

with the option to turn on this lamp for these types of trailers, then this lamp will turn on when that trailer ABS has a system problem. This should be checked by a dealer as soon as possible. The Trailer ABS Warning Lamp will not turn on for the power-on test when connected to these types of trailers.



### NOTE

Very few trailers built before 03/01/2001 have this option. Trailers built after 03/01/2001 are built with PLC technology.

# Chapter 5 | MAINTENANCE

5

New Vehicle Maintenance Schedule.....	171
First Day.....	171
First 50-100 mi / 80-160 km.....	171
First 500 mi / 800 km.....	172
First 2,000 mi / 3,218 km.....	172
First 3,000-5,000 mi / 4,800-8,000 km.....	172
Preventive Maintenance Intervals.....	173
Fender Liners.....	196
Lubricants.....	197
Air System.....	204
Dual Air System Function Test.....	206
Air Dryer Maintenance.....	206
Air Tanks.....	208
Air Gauges and Air Leaks.....	209
Air Compressor.....	210
Brake System.....	211

Cab Maintenance..... 217

Safety Restraint System - Inspection..... 223

Cooling System Maintenance..... 225

Windshield Wiper/Washer..... 229

Headlights..... 230

Electrical System..... 232

Engine Maintenance..... 241

Fuel System..... 249

Frame..... 250

Front Axle and Suspension..... 252

Heater and Air Conditioner Maintenance..... 255

Noise and Emission Control..... 257

Diesel Exhaust Fluid Tank..... 260

Rear Axle and Suspension..... 260

Rear Axle Alignment..... 263

Steering System..... 264

Driveline..... 266

Tires..... 266

Wheels..... 269

Transmission Maintenance..... 273  
Hydraulic Clutch..... 273  
Specification Reference Charts..... 274

5

## New Vehicle Maintenance Schedule First Day

<b>First Day</b>
Perform a total vehicle alignment once a body is installed on the truck chassis.
Steering U-joint Pinch Bolt <ul style="list-style-type: none"> <li>• Refer to <a href="#">Steering Shaft Bolt Torque Specifications</a> on page 265 for maintenance instructions.</li> </ul>
Front Suspension - U-bolts <ul style="list-style-type: none"> <li>• Check the general condition and the tightness of the nuts. Tighten the U-bolts using a calibrated torque wrench to the specified torque value. (Refer to <a href="#">Suspension U-Bolts, Grade 8</a> on page 282 for maintenance instructions.)</li> </ul>

5

### First 50-100 mi / 80-160 km

<b>First 50-100 mi / 80-160 km<sup>13</sup></b>
Wheel Mounting <ul style="list-style-type: none"> <li>• Refer to <a href="#">Wheels</a> on page 269 for maintenance instructions.</li> </ul>

<sup>13</sup> Ensure that all maintenance intervals leading up to this point are repeated during this interval prior to the completion of those listed here.

## First 500 mi / 800 km

### First 500 mi / 800 km<sup>14</sup>

#### Front Axle U-Bolt Torque

- Refer to [Suspension U-Bolts, Grade 8](#) on page 282 for maintenance instructions.

#### Charge Air Cooler and Air Intake Pipe Clamps

- Retorque fasteners. Refer to [Pipe and Hose Clamp Torque Values](#) on page 243 for maintenance instructions.

5

## First 2,000 mi / 3,218 km

### First 2,000 mi / 3,218 km<sup>15</sup>

#### Rear Suspension Fasteners

- Refer to [Rear Axle and Suspension](#) on page 260 for maintenance instructions.

## First 3,000-5,000 mi / 4,800-8,000 km

---

<sup>14</sup> Ensure that all maintenance intervals leading up to this point are repeated during this interval prior to the completion of those listed here.

<sup>15</sup> Ensure that all maintenance intervals leading up to this point are repeated during this interval prior to the completion of those listed here.

**First 3,000-5,000 mi / 4,800-8,000 km <sup>16</sup>**

**Transmission Lubrication**

- For Fuller transmission, refer to [Fuller Transmission Lubrication](#) on page 199 for maintenance instructions.
- For Allison transmission, refer to [Allison Transmission Lubrication](#) on page 200 for maintenance instructions.

**Axle Lubrication.**

- For Meritor axle, refer to [Meritor Axle Lubrication](#) on page 201 for maintenance instructions.
- For Eaton/Dana axle, refer to [Eaton/Dana Axle Lubrication](#) on page 202 for maintenance instructions.

## Preventive Maintenance Intervals

Preventive maintenance program begins with the daily checks. Routine vehicle checks can help avoid many large, expensive, and time consuming repairs. The vehicle will operate better, be safer, and last longer. Neglect of recommended maintenance can void your vehicle's warranty. Some maintenance operations demand skills and equipment you may not have. For such situations, please take your vehicle to an authorized Service Center.



**WARNING**

Before attempting any procedures in the engine compartment, stop the engine and let it cool down. Hot components can burn skin on contact. Failure to comply may result in death, personal injury, equipment or property damage.



**WARNING**

If the engine must be operating to inspect, be alert and cautious around

the engine at all times. Failure to comply may result in death, personal injury, equipment or property damage.



**WARNING**

If work has to be done with the engine running, always (1) set the parking brake, (2) block the wheels, and (3) ensure that the shift lever or selector is in Neutral. Failure to comply may result in death, personal injury, equipment or property damage.

<sup>16</sup> Ensure that all maintenance intervals leading up to this point are repeated during this interval prior to the completion of those listed here.



**WARNING**

Exercise extreme caution to prevent neckties, jewelry, long hair or loose clothing from getting caught in the fan blades or another moving engine parts. Failure to comply may result in death, personal injury, equipment or property damage.



**WARNING**

Always support the vehicle with appropriate safety stands if it is necessary to work underneath the vehicle. A jack is not adequate for this purpose. Failure to comply may result in death, personal injury, equipment or property damage.



**WARNING**

When working underneath the vehicle without appropriate safety stands but with the wheels on the ground (not supported), make sure that (1) the vehicle is on hard level ground, (2) the

parking brake is applied, (3) all wheels are blocked (front and rear) and (4) remove the ignition key so that the engine cannot be started. Failure to comply may result in death, personal injury, equipment or property damage.



**WARNING**

NEVER start or let the engine run in an enclosed, unventilated area. Exhaust fumes from the engine contain carbon monoxide, a colorless and odorless gas. Carbon monoxide can be fatal if inhaled. Failure to comply may result in property damage, personal injury, or death.



**WARNING**

Disconnect the battery ground cable whenever you work on the fuel system or the electrical system. When you work around fuel, do not smoke or work near heaters or other fire hazards. Keep an approved fire extinguisher near to you. Failure to comply

may result in death, personal injury, equipment or property damage.

The following pages contain a table of maintenance tasks with the related intervals for each task on the right side of the table. The top of the table displays a guide to a maintenance interval and its schedule. Some tasks are dependent on the vehicle application. These tasks will be shown as separate tasks and will have the words "ON HIGHWAY", "CITY DELIVERY" or "OFF-HIGHWAY" after the description. These tasks are differentiated because they are dependent on the vehicle's operating environment. On highway is defined for applications where the vehicle is NOT used off of a paved road during normal operation. City Delivery is defined for applications where frequent start and stopping is required during normal operation and the highway is used infrequently and for short periods of time. Off highway is defined for applications where the vehicle may be driven off the pavement on a regular basis, even if it is an infrequent basis and/or for a brief time period. Please contact an authorized service dealership if there are questions regarding which interval to follow. Consult the supplier for specific recommendations



where discrepancies develop between these recommendations in this table and component supplier recommendations.

- Engine lubricating oil change intervals aren't listed here. Refer to your engine's operating manual for recommendations. For specific information on maintenance procedures consult your vehicle maintenance manual.

- The initial fill of drive axle lubricant must be changed before the end of the first scheduled maintenance interval. See the axle manufacturer's operator's manual for recommended lubrication specifications and service intervals.
- The initial fill of lubricant in manual transmissions must be changed before the end of the first

maintenance interval. See the transmission manufacturer's operator's manual for recommended lubrication specifications and service intervals.

- If your vehicle is equipped with an automatic transmission, consult the owner's manual for it that came with your vehicle to obtain lubricant check and change intervals.

Drive Axle (Dana) - Axle Housing
<ul style="list-style-type: none"> <li>• Drain the lubricant while warm. Flush each unit with clean flushing oil. Change the lubricant. (Refer to <a href="#">Eaton/Dana Axle Lubrication</a> on page 202 for maintenance instructions.)</li> </ul>
Drive Axle (Meritor) - Axle Housing
<ul style="list-style-type: none"> <li>• Drain and replace the lubricant. (Refer to <a href="#">Meritor Axle Lubrication</a> on page 201 for maintenance instructions.)</li> </ul>
Main transmission
<ul style="list-style-type: none"> <li>• Check the oil level; refill as required. Check every 50,000 mi and refill as required. (Refer to <a href="#">Main transmission</a> on page 198 for maintenance instructions.)</li> </ul>
Air Intake - Air cleaner
<ul style="list-style-type: none"> <li>• Replace the engine intake air cleaner element. When required by air restriction indicator or required by the engine manufacturer's operator manual. (Refer to <a href="#">Air Intake System</a> on page 245 for maintenance instructions.)</li> </ul>
Tires and Wheels - Tires
<ul style="list-style-type: none"> <li>• Check inflation pressure. Weekly "cold" using calibrated gauge. (Refer to <a href="#">Tires</a> on page 266 for maintenance instructions.)</li> </ul>

Driveshafts - Models SPL-90, 1710 and 1810 slip member and U-joints
<ul style="list-style-type: none"> <li>Inspect. U-joint inspections should be performed every time a vehicle comes in for scheduled maintenance.**</li> </ul>
Driveshafts - Models SPL-100 slip member and U-joints
<ul style="list-style-type: none"> <li>Inspect. U-joint inspections should be performed every time a vehicle comes in for scheduled maintenance.**</li> </ul>
Driveshafts - Models SPL-140/140HD/170/170HD/250/250HD slip members and U-joints (ON HIGHWAY and LINEHAUL)
<ul style="list-style-type: none"> <li>Inspect. U-joint inspections should be performed every time a vehicle comes in for scheduled maintenance.**</li> </ul>
Driveshafts - Models SPL-140XL/170XL/ 250XL slip members and U-joints (OFF HIGHWAY)
<ul style="list-style-type: none"> <li>Lubricate*. 350,000 mi (560,000 km) 1st interval and then every 100,000 mi (160,00 km) after that.</li> </ul>
Driveshafts - Models SPL-140XL/170XL/ 250XL slip members and U-joints (ON HIGHWAY and LINE HAUL)
<ul style="list-style-type: none"> <li>Inspect. U-joint inspections should be performed every time a vehicle comes in for scheduled maintenance.**</li> </ul>
Driveshafts - Models SPL-140XL/170XL/ 250XL slip members and U-joints (OFF HIGHWAY and CITY)
<ul style="list-style-type: none"> <li>Inspect. U-joint inspections should be performed every time a vehicle comes in for scheduled maintenance.**</li> </ul>
Aftertreatment System - Diesel particulate filter
<ul style="list-style-type: none"> <li>Clean filter. Refer to the <i>Engine Maintenance Manual</i>.</li> </ul>
Aftertreatment System - Diesel exhaust fluid supply module
<ul style="list-style-type: none"> <li>Replace filter. Refer to the <i>Engine Maintenance Manual</i>.</li> </ul>
Air - Air dryer (ON HIGHWAY)

<ul style="list-style-type: none"> <li>Overhaul. 360,000 miles/576,000 km (Refer to <a href="#">Air Dryer Maintenance</a> on page 206 for maintenance instructions.)</li> </ul>
Safety - Three-point Safety Belt System
<ul style="list-style-type: none"> <li>Inspect. 20,000 miles/32,000km If the vehicle is exposed to severe environmental or working conditions, more frequent inspections may be necessary. (Refer to <a href="#">Safety Restraint System - Inspection</a> on page 223 for maintenance instructions.)</li> </ul>

**Every 50 Hours**

**Every 750 mi / 1,207 km / 1 mo**

Every 50 Hours <sup>17</sup>
<p>Steer Axles - Kingpin Joint Grease / Tie Rod Ends with Heavy-Duty Multipurpose Lithium Based Lubricant</p> <ul style="list-style-type: none"> <li>Use #1 Grade or #2 Grade: See Kingpins, Thrust Bearings, and Tie Rod Ends.</li> </ul>

\* Use only Spicer Driveshaft approved lubricants when greasing Spicer U-joints.

\*\* Refer to Spicer Driveshaft service manual DSSM-0100 (3264-SPL) for detailed instructions.

**17 Ensure that all maintenance intervals leading up to this point are repeated during this interval prior to the completion of those listed here.**

**Every 750 mi / 1,207 km / 1 mo <sup>18</sup>**

Front Axle (Meritor) - Total Vehicle Alignment

- Check and adjust as required. (Refer to [Front Axle and Suspension](#) on page 252 for maintenance instructions.)

Front Axle (Meritor) - Drawkeys

- Tighten nuts. (Refer to [Steering System](#) on page 264 for maintenance instructions.)

Front Axle (Dana) - Total Vehicle Alignment

- Check and adjust as required. (Refer to [Front Axle and Suspension](#) on page 252 for maintenance instructions.)

Disc Brakes (Bendix®) - System operation

- Check operation; inspect as per manufacturer's service literature. (Refer to [Air Disc Brakes](#) on page 212 for maintenance instructions.)

**Every 7,500 mi / 12,000 km / 6 mo**

**Every 7,500 mi / 12,000 km / 6 mo <sup>19</sup>**

Frame - Fifth Wheel

- Check the kingpin lock and plate for wear and function; lubricate (NLGI #2 grease). (Refer to [Fifth Wheel Monthly Maintenance](#) on page 251 for maintenance instructions.)
- Inspect fifth wheel operation. (Refer to [Frame Fastener Torque Requirements](#) on page 280 for maintenance instructions.)

<sup>18</sup> Ensure that all maintenance intervals leading up to this point are repeated during this interval prior to the completion of those listed here.

<sup>19</sup> Ensure that all maintenance intervals leading up to this point are repeated during this interval prior to the completion of those listed here.

Every 7,500 mi / 12,000 km / 6 mo <sup>19</sup>
<p>Frame - Frame Fasteners</p> <ul style="list-style-type: none"> <li>• Check for tightness. (Refer to <a href="#">Frame Fastener Torque Requirements</a> on page 280 for maintenance instructions.)</li> </ul>
<p>Frame - Engine Mounting</p> <ul style="list-style-type: none"> <li>• Refer to <a href="#">Engine Mounting</a> on page 249 for maintenance instructions. Contact an authorized vehicle OEM dealership if engine mounts need servicing.</li> </ul>
<p>Front Suspension - Spring Pins</p> <ul style="list-style-type: none"> <li>• Check for proper function. (Refer to <a href="#">Front Axle and Suspension</a> on page 252 for maintenance instructions.)</li> </ul>
<p>Drum Brakes (All) - Slack adjusters</p> <ul style="list-style-type: none"> <li>• Check the push rod travel and check the control arm for cracks. Adjust at reline. (Refer to <a href="#">Operational Checks of Automatic Slack Adjusters</a> on page 213 for maintenance instructions.)</li> <li>• Lubricate (NLGI #2 grease).</li> </ul>
<p>Drum Brakes (All) - Brake air system</p> <ul style="list-style-type: none"> <li>• Check air lines and fittings for leaks. Adjust routing as required to prevent chafing. Check tank mounting and condition. (Refer to <a href="#">Air System</a> on page 204 for maintenance instructions.)</li> </ul>
<p>Drum Brakes (All) - Brake lining</p> <ul style="list-style-type: none"> <li>• Inspect; replace as required. (Refer to <a href="#">Drum Brake Inspection</a> on page 214 for maintenance instructions.)</li> </ul>
<p>Disc Brakes (Bendix®) - Brake pads</p> <ul style="list-style-type: none"> <li>• Inspect; replace as required. (Refer to <a href="#">Air Disc Brakes</a> on page 212 for maintenance instructions.)</li> </ul>

<sup>19</sup> Ensure that all maintenance intervals leading up to this point are repeated during this interval prior to the completion of those listed here.

Every 7,500 mi / 12,000 km / 6 mo <sup>19</sup>
<p>Disc Brakes (Bendix®) - Caliper sliding function</p> <ul style="list-style-type: none"> <li>• Ensure caliper slides freely with no obstructions or excessive play. (Refer to <a href="#">Air Disc Brakes</a> on page 212 for maintenance instructions.)</li> </ul>
<p>Disc Brakes (Bendix®) - Caliper slide pins</p> <ul style="list-style-type: none"> <li>• Inspect protective caps of the guide pins for damage or cracking. (Refer to <a href="#">Air Disc Brakes</a> on page 212 for maintenance instructions.)</li> </ul>
<p>Hydraulic Brakes - Brake pad lining</p> <ul style="list-style-type: none"> <li>• Inspect; replace as required. (minimum 3/16 in. thickness) (Refer to <a href="#">Service Brake Component Inspection</a> on page 216 for maintenance instructions.)</li> </ul>
<p>Hydraulic Brakes - Brake Fluid</p> <ul style="list-style-type: none"> <li>• Check level; change every 2 years. (DOT 3 brake fluid) (Refer to <a href="#">Brake Fluid Check and Refill</a> on page 215 for maintenance instructions.)</li> </ul>
<p>Air Intake - Air intake piping, mounting, and charge air cooler</p> <ul style="list-style-type: none"> <li>• Check the system for broken pipes, leaks, joint integrity, cleanliness, and proper support. (Refer to <a href="#">Air Intake System</a> on page 245 for maintenance instructions.)</li> </ul>
<p>Tires and Wheels - Tires</p> <ul style="list-style-type: none"> <li>• Inspect for cuts, irregular wear, missing lugs, sidewall damage, etc. (Refer to <a href="#">Tires</a> on page 266 for maintenance instructions.)</li> </ul>
<p>Fuel and Tanks - Fuel tanks <a href="#">Fuel Tank</a> on page 250</p>

<sup>19</sup> Ensure that all maintenance intervals leading up to this point are repeated during this interval prior to the completion of those listed here.

<b>Every 7,500 mi / 12,000 km / 6 mo <sup>19</sup></b>
Driveshafts - Models SPL-90, 1710 and 1810 slip member and U-joints <ul style="list-style-type: none"> <li>Lubricate *</li> </ul>
Driveshafts - Models SPL-100 slip member and U-joints <ul style="list-style-type: none"> <li>Lubricate *</li> </ul>
Driveshafts - Models SPL-140/140HD/170/170HD/250/250HD slip members and U-joints (OFF HIGHWAY) <ul style="list-style-type: none"> <li>Lubricate *</li> </ul>
Battery Boxes, Tool Boxes, and Steps - Battery cables <ul style="list-style-type: none"> <li>Check the condition of the cables, cushion clamps, nylon tie straps, and routing. Replace a cushion clamp if the rubber has deteriorated. Repair or tighten terminals, and secure cables to prevent chafing. Replace damaged cables. (cuts, cracks, or excessive wear) (Refer to <a href="#">Batteries</a> on page 236 for maintenance instructions.)</li> </ul>
Battery Boxes, Tool Boxes, and Steps - Batteries (ON HIGHWAY and LINE HAUL) <ul style="list-style-type: none"> <li>Check for cracks and damage, electrolyte level, condition of terminals, and tightness of holdowns. (Refer to <a href="#">Batteries</a> on page 236 for maintenance instructions.)</li> </ul>
Battery Boxes, Tool Boxes, and Steps - Batteries (OFF HIGHWAY) <ul style="list-style-type: none"> <li>Check for cracks and damage, electrolyte level, condition of terminals, and tightness of holdowns. (Refer to <a href="#">Batteries</a> on page 236 for maintenance instructions.)</li> </ul>
Battery Boxes, Tool Boxes, and Steps - Battery box and tray (ON HIGHWAY and LINE HAUL) <ul style="list-style-type: none"> <li>Check the box integrity. Clean the drain tube and check for acid leaks. Check condition of all equipment mounted under the box. (Refer to <a href="#">Batteries</a> on page 236 for maintenance instructions.)</li> </ul>

<sup>19</sup> Ensure that all maintenance intervals leading up to this point are repeated during this interval prior to the completion of those listed here.

Every 7,500 mi / 12,000 km / 6 mo <sup>19</sup>
<p>Battery Boxes, Tool Boxes, and Steps - Battery box and tray (OFF HIGHWAY)</p> <ul style="list-style-type: none"> <li>• Check the box integrity. Clean the drain tube and check for acid leaks. Check condition of all equipment mounted under the box. (Refer to <a href="#">Batteries</a> on page 236 for maintenance instructions.)</li> </ul>
<p>Battery Boxes, Tool Boxes, and Steps - Battery Cable Fasteners</p> <ul style="list-style-type: none"> <li>• Check battery cable fasteners and tighten as necessary to 10-15 lb-ft (13.6-20.3 N·m) as specified on the battery label. (Refer to <a href="#">Batteries</a> on page 236 for maintenance instructions.)</li> </ul>
<p>Electrical and lights - Headlights</p> <ul style="list-style-type: none"> <li>• Check the aim and adjust as required. (Refer to <a href="#">Aiming Headlights</a> on page 232.)</li> </ul>
<p>Electrical and lights - Warning lights in light bar</p> <ul style="list-style-type: none"> <li>• Check at the ignition start position to verify bulbs and driver information display function. (Shown in <a href="#">Indications</a> on page 49.)</li> </ul>
<p>Electrical and lights - Turn, Stop, Reverse lights and signals</p> <ul style="list-style-type: none"> <li>• Visual check. (Refer to <a href="#">Daily Checks</a> on page 24.)</li> </ul>
<p>Electrical and lights - Alternator</p> <ul style="list-style-type: none"> <li>• Check operation and output. (Refer to <a href="#">Alternator</a> on page 240 for maintenance instructions.)</li> <li>• Check tightness of the pulley nut. (Refer to <a href="#">Install Engine Belt</a> on page 244 for maintenance instructions.)</li> <li>• Check the tension of the drive belt. (Refer to <a href="#">Install Engine Belt</a> on page 244 for maintenance instructions.)</li> <li>• Check tightness of the terminal hex nuts. (Refer to <a href="#">Install Engine Belt</a> on page 244 for maintenance instructions.)</li> </ul>
<p>Electrical and lights - Starter</p> <ul style="list-style-type: none"> <li>• Check torque on hex nuts. (Refer to <a href="#">Electrical System</a> on page 232 for maintenance instructions.)</li> </ul>

<sup>19</sup> Ensure that all maintenance intervals leading up to this point are repeated during this interval prior to the completion of those listed here.



Every 7,500 mi / 12,000 km / 6 mo <sup>19</sup>
Electrical and lights - ECM connector <ul style="list-style-type: none"> <li>• Check the tightness of the ECM connector. (Refer to <a href="#">Electrical System</a> on page 232 for maintenance instructions.)</li> </ul>
Electrical and lights - Wheel sensors <ul style="list-style-type: none"> <li>• Check for damaged sensors and connectors, and worn or frayed wires. (Refer to <a href="#">Electrical System</a> on page 232 for maintenance instructions.)</li> </ul>
Electrical and lights - Fuel and diesel exhaust fluid tank sending unit <ul style="list-style-type: none"> <li>• Check the mounting screws and electrical connections for worn or damaged wires and connectors. (Refer to <a href="#">Diesel Exhaust Fluid Tank</a> on page 260 for maintenance instructions.)</li> </ul>
Electrical and lights - Power supply harnesses (engine, transmission, etc.) <ul style="list-style-type: none"> <li>• Check for worn or damaged insulation, corroded terminals, frayed wires, and oil or fluid leaks on the connectors or wiring. (Refer to <a href="#">Electrical System</a> on page 232 for maintenance instructions.)</li> <li>• Wash to remove excess grease. (Refer to <a href="#">Electrical System</a> on page 232 for maintenance instructions.)</li> </ul>
Heating and Air Conditioning - Heater and air conditioner <ul style="list-style-type: none"> <li>• Perform the checks listed. (Refer to <a href="#">Heater and Air Conditioner Maintenance</a> on page 255 for maintenance instructions.)</li> </ul>
Aftertreatment System - System <ul style="list-style-type: none"> <li>• Check for leaks and proper support. (Refer to <a href="#">Noise and Emission Control</a> on page 257 for maintenance instructions.)</li> </ul>
Aftertreatment System - Diesel exhaust fluid tank <ul style="list-style-type: none"> <li>• Inspect the tank, straps, brackets, hoses and fittings for abrasion damage, leaks, tightness and fully engaged connectors. (Refer to <a href="#">Diesel Exhaust Fluid Tank</a> on page 260 for maintenance instructions.)</li> </ul>

<sup>19</sup> Ensure that all maintenance intervals leading up to this point are repeated during this interval prior to the completion of those listed here.

**Every 7,500 mi / 12,000 km / 6 mo <sup>19</sup>**

Air - Air compressor governor

- Replace air strainer. (Refer to [Air Compressor](#) on page 210 for maintenance instructions.)

Air - Air lines

- Check condition and routing to prevent chafing. (Refer to [Air Compressor](#) on page 210 for maintenance instructions.)

Air - System

- Lubricate. (Refer to [Air System](#) on page 204 for maintenance instructions.)

Air - Inline filters

- Replace elements or clean with solvent. (Refer to [Air System](#) on page 204 for maintenance instructions.)

Air - Air dryer

- Perform the checks listed. (Refer to [Air System](#) on page 204 for maintenance instructions.)

**Every 15,000 mi / 24,000 km / 12 mo**

---

<sup>19</sup> **Ensure that all maintenance intervals leading up to this point are repeated during this interval prior to the completion of those listed here.**

\* Use only Spicer Driveshaft approved lubricants when greasing Spicer U-joints.

<b>Every 15,000 mi / 24,000 km / 12 mo <sup>20</sup></b>
Air Intake - Pre-cleaner Filter Assembly <ul style="list-style-type: none"> <li>• Clean Pre-cleaner filter media. (Refer to <a href="#">How to Clean the Pre-cleaner Filter</a> on page 247.)</li> </ul>
Frame - Crossmembers and Mounting Brackets <ul style="list-style-type: none"> <li>• Inspect for cracks and loose fasteners. Replace or tighten to the specified torque value as required. (Refer to <a href="#">Frame Fastener Torque Requirements</a> on page 280 for maintenance instructions.)</li> </ul>
Front Axle (Meritor) - Steering knuckle spindles, thrust bearings, kingpins, drawkeys, tie rod ends, steering stops, and bushings <ul style="list-style-type: none"> <li>• Inspect for wear and damage and endplay. Shim or replace as required. (Refer to <a href="#">Steering System</a> on page 264 for maintenance instructions.)</li> </ul>
Front Axle (Meritor) - Kingpin bushings, thrust bearings, and tie rod ball ends <ul style="list-style-type: none"> <li>• Lubricate with approved grease. (Refer to <a href="#">Meritor Axle Lubrication</a> on page 201 for maintenance instructions.)</li> </ul>
Front Axle (Meritor) - Drawkeys <ul style="list-style-type: none"> <li>• Tighten nuts. (Refer to <a href="#">Steering System</a> on page 264 for maintenance instructions.)</li> </ul>
Front Axle (Dana) - Kingpin bushings, thrust bearings, and tie rod ball ends (ON HIGHWAY) <ul style="list-style-type: none"> <li>• Lubricate with approved grease. (Refer to <a href="#">Eaton/Dana Axle Lubrication</a> on page 202 for maintenance instructions.)</li> </ul>
Front Axle (Dana) - Kingpin bushings, thrust bearings, and tie rod ball ends (OFF HIGHWAY) <ul style="list-style-type: none"> <li>• Lubricate with approved grease. (Refer to <a href="#">Eaton/Dana Axle Lubrication</a> on page 202 for maintenance instructions.)</li> </ul>

<sup>20</sup> Ensure that all maintenance intervals leading up to this point are repeated during this interval prior to the completion of those listed here.

Every 15,000 mi / 24,000 km / 12 mo <sup>20</sup>
<p>Front Axle (Dana) - Steering knuckle spindles, thrust bearings, kingpins, drawkeys, tie rod ends, steering stops, and bushings (ON HIGHWAY)</p> <ul style="list-style-type: none"> <li>Inspect for wear and damage and for endplay. Shim or replace as required. (Refer to <a href="#">Front Axle and Suspension</a> on page 252 for maintenance instructions.)</li> </ul>
<p>Front Axle (Dana) - Steering knuckle spindles, thrust bearings, kingpins, drawkeys, tie rod ends, steering stops, and bushings (OFF HIGHWAY)</p> <ul style="list-style-type: none"> <li>Inspect for wear and damage and for endplay. Shim or replace as required. (Refer to <a href="#">Front Axle and Suspension</a> on page 252 for maintenance instructions.)</li> </ul>
<p>Front Suspension - Front Spring</p> <ul style="list-style-type: none"> <li><a href="#">Front Axle and Suspension</a> on page 252 for maintenance instructions.)</li> </ul>
<p>Front Suspension - Spring Pins and Shackles</p> <ul style="list-style-type: none"> <li>Inspect for worn parts and excessive joint clearance. Shim or replace as required. (Refer to <a href="#">Front Axle and Suspension</a> on page 252 for maintenance instructions.)</li> </ul>
<p>Front Suspension - Shock Absorbers</p> <ul style="list-style-type: none"> <li>Inspect for leaking, body damage, and damaged or worn bushings. Replace as required. Check the shock mounting stud torque. (Refer to <a href="#">Front Axle and Suspension</a> on page 252 for maintenance instructions.)</li> </ul>
<p>Front Suspension - Spring Pins</p> <ul style="list-style-type: none"> <li>Lubricate with approved grease. (Refer to <a href="#">Front Axle and Suspension</a> on page 252 for maintenance instructions.)</li> </ul>

<sup>20</sup> Ensure that all maintenance intervals leading up to this point are repeated during this interval prior to the completion of those listed here.

Every 15,000 mi / 24,000 km / 12 mo <sup>20</sup>
<p>Front Suspension - U-bolts (ON HIGHWAY)</p> <ul style="list-style-type: none"> <li>• Check the general condition and the tightness of the nuts. Tighten the nuts to the specified torque value as required. (Refer to <a href="#">Suspension U-Bolts, Grade 8</a> on page 282 for maintenance instructions.)</li> </ul>
<p>Front Suspension - U-bolts (OFF HIGHWAY)</p> <ul style="list-style-type: none"> <li>• Check the general condition and the tightness of the nuts. Tighten the U-bolts after the first day or two of operation. Then tighten the nuts to the specified torque value as required. (Refer to <a href="#">Suspension U-Bolts, Grade 8</a> on page 282 for maintenance instructions.)</li> </ul>
<p>Drive Axle (Dana) - Axle Housing</p> <ul style="list-style-type: none"> <li>• Visually inspect for damage or leaks. (Refer to <a href="#">Drive Axle - Dana</a> on page 263.)</li> <li>• Check oil level. Check "cold." Torque the drain plug. (Refer to <a href="#">Drive Axle - Dana</a> on page 263.)</li> </ul>
<p>Drive Axle (Dana) - Air Shift Unit</p> <ul style="list-style-type: none"> <li>• Check the lubricant level. (Refer to <a href="#">Drive Axle - Dana</a> on page 263.)</li> <li>• Remove the housing cover and drain the lubricant. Wash the parts thoroughly and dry in air. (Refer to <a href="#">Drive Axle - Dana</a> on page 263.)</li> </ul>
<p>Drive Axle (Dana) - Breather</p> <ul style="list-style-type: none"> <li>• Clean or replace. (Refer to <a href="#">Drive Axle - Dana</a> on page 263.)</li> </ul>
<p>Drive Axle (Dana) - Lube Pump (ON HIGHWAY)</p> <ul style="list-style-type: none"> <li>• Remove the magnetic strainer and inspect for wear particles. Wash in solvent and dry in air. (Refer to <a href="#">Drive Axle - Dana</a> on page 263.)</li> </ul>

<sup>20</sup> Ensure that all maintenance intervals leading up to this point are repeated during this interval prior to the completion of those listed here.

Every 15,000 mi / 24,000 km / 12 mo <sup>20</sup>
<p>Drive Axle (Dana) - Lube Pump (OFF HIGHWAY)</p> <ul style="list-style-type: none"> <li>Remove the magnetic strainer and inspect for wear particles. Wash in solvent and dry in air. (Refer to <a href="#">Drive Axle - Dana</a> on page 263.)</li> </ul>
<p>Drive Axle (Dana) - Lube Filter (ON HIGHWAY)</p> <ul style="list-style-type: none"> <li>Change. (Refer to <a href="#">Drive Axle - Dana</a> on page 263.)</li> </ul>
<p>Drive Axle (Dana) - Lube Filter (OFF HIGHWAY)</p> <ul style="list-style-type: none"> <li>Change. (Refer to <a href="#">Drive Axle - Dana</a> on page 263.)</li> </ul>
<p>Inspect for cracked leaves, worn bushings, and excessiveDrive Axle (Dana) - Magnetic drain plug and breather (ON HIGHWAY)</p> <ul style="list-style-type: none"> <li>Clean or replace. (Refer to <a href="#">Drive Axle - Dana</a> on page 263.)</li> </ul>
<p>Drive Axle (Dana) - Magnetic drain plug and breather (OFF HIGHWAY)</p> <ul style="list-style-type: none"> <li>Clean or replace. (Refer to <a href="#">Drive Axle - Dana</a> on page 263.)</li> </ul>
<p>Drive Axle (Meritor) - Axle Housing</p> <ul style="list-style-type: none"> <li>Check the "cold" fill level at the differential carrier plug for a pinion angle of less than 7 degrees, or at the axle bowl plug for a pinion angle of greater than 7 degrees. Tighten the plug to 35-50 lb-ft (47-68 N·m). (Refer to <a href="#">Drive Axle - Meritor</a> on page 263.)</li> <li>Visually inspect for damage or leaks. (Refer to <a href="#">Drive Axle - Meritor</a> on page 263.)</li> </ul>
<p>Drive Axle (Meritor) - Lubricant filter</p> <ul style="list-style-type: none"> <li>Change the filter. (Refer to <a href="#">Drive Axle - Meritor</a> on page 263.)</li> </ul>
<p>Drive Axle (Meritor) - Breather</p> <ul style="list-style-type: none"> <li>Check the operation. If the cap doesn't rotate freely, replace. (Refer to <a href="#">Drive Axle - Meritor</a> on page 263.)</li> </ul>

<sup>20</sup> Ensure that all maintenance intervals leading up to this point are repeated during this interval prior to the completion of those listed here.

Every 15,000 mi / 24,000 km / 12 mo <sup>20</sup>
<p>Drive Axle (Meritor) - Input shaft and pinion shaft</p> <ul style="list-style-type: none"> <li>• Check and adjust the endplay. (Refer to <a href="#">Drive Axle - Meritor</a> on page 263.)</li> </ul>
<p>Drive Axle (Meritor) - Axle shaft</p> <ul style="list-style-type: none"> <li>• Tighten the rear axle flange nuts to the specified torque value. (Refer to <a href="#">Drive Axle - Meritor</a> on page 263.)</li> </ul>
<p>Drive Axle (Meritor) - Interaxle differential</p> <ul style="list-style-type: none"> <li>• Check the operation. (Refer to <a href="#">Inter-Axle Differential Lock Operation</a> on page 148 for maintenance instructions.)</li> </ul>
<p>Rear Suspension - U-bolts</p> <ul style="list-style-type: none"> <li>• Check the torque. Tighten to specified torque value as required. (Refer to <a href="#">Suspension U-Bolts, Grade 8</a> on page 282.)</li> </ul>
<p>Rear Suspension - Frame and crossmember bolts</p> <ul style="list-style-type: none"> <li>• Check the torque. Tighten to specified torque value as required. (Refer to <a href="#">Frame Fastener Torque Requirements</a> on page 280.)</li> </ul>
<p>Rear Suspension - Mounting brackets and fasteners</p> <ul style="list-style-type: none"> <li>• Check the condition and the fastener torque. Tighten to the specified torque value as required. (Refer to <a href="#">Frame Fastener Torque Requirements</a> on page 280.)</li> </ul>
<p>Drum Brakes (All) - Brake camshaft bearing</p> <ul style="list-style-type: none"> <li>• Check for excessive camshaft play in the axial and radial directions. Max allowable play is 0.003 in. Lubricate (NLGI #2 grease). (Refer to <a href="#">Drum Brake Inspection</a> on page 214.)</li> </ul>
<p>Drum Brakes (All) - Brake treadle valve</p> <ul style="list-style-type: none"> <li>• Clean the area around the treadle, boot, and mounting plate. Check the pivot and mounting plate for integrity. Check the plunger boot for cracks. Lubricate roller pin, pivot pin, and plunger (NLGI #2 grease). (Refer to <a href="#">Drum Brake Inspection</a> on page 214.)</li> </ul>

<sup>20</sup> Ensure that all maintenance intervals leading up to this point are repeated during this interval prior to the completion of those listed here.

Every 15,000 mi / 24,000 km / 12 mo <sup>20</sup>
<p>Drum Brakes (All) - Brake air system</p> <ul style="list-style-type: none"> <li>Clean or replace the inline filters. (Refer to <a href="#">Air System</a> on page 204.)</li> </ul>
<p>Disc Brakes (Bendix®) - Brake disc/rotor</p> <ul style="list-style-type: none"> <li>Inspect for visible cracks, heat checking, galling, or scoring of surface. Check for runout (max allowable is 0.002 in.). (Refer to <a href="#">Air Disc Brakes</a> on page 212 for maintenance instructions.)</li> </ul>
<p>Hydraulic Brakes - Rotor</p> <ul style="list-style-type: none"> <li>Inspect for visible cracks, heat checking, galling, or scoring of surface. (Refer to <a href="#">Hydraulic Brake System</a> on page 214 for maintenance instructions.)</li> </ul>
<p>Hydraulic Brakes - Park Brake</p> <ul style="list-style-type: none"> <li>Inspect for wear, cracks, or breakage. (minimum 2.5 mm (0.10 in)) (Refer to <a href="#">Hydraulic Brake System</a> on page 214 for maintenance instructions.)</li> </ul>
<p>Clutch - Clutch linkage</p> <ul style="list-style-type: none"> <li>Lubricate. (Refer to <a href="#">Hydraulic Clutch</a> on page 273 for maintenance instructions.)</li> </ul>
<p>Clutch - Clutch release bearing</p> <ul style="list-style-type: none"> <li>Lubricate. (Refer to <a href="#">Hydraulic Clutch</a> on page 273 for maintenance instructions.)</li> <li>Inspect and adjust when necessary (no adjustment required for SOLO type clutches). (Refer to <a href="#">Hydraulic Clutch</a> on page 273 for maintenance instructions.)</li> </ul>
<p>Cooling - Hoses</p> <ul style="list-style-type: none"> <li>Check the radiator and heater hoses for leaks. (Refer to <a href="#">Radiator Hoses</a> on page 228 for maintenance instructions.)</li> </ul>

<sup>20</sup> Ensure that all maintenance intervals leading up to this point are repeated during this interval prior to the completion of those listed here.



Every 15,000 mi / 24,000 km / 12 mo <sup>20</sup>
<p>Cooling - Extended Life Coolant (ELC)</p> <ul style="list-style-type: none"> <li>• Check the freeze point. (Refer to <a href="#">Cooling System Maintenance</a> on page 225)</li> <li>• Check for contamination using test strips. (Refer to <a href="#">Cooling System Maintenance</a> on page 225 for maintenance instructions.)</li> <li>• Replace blank water filter if applicable.</li> <li>• Perform lab analysis. (Refer to <a href="#">Cooling System Maintenance</a> on page 225 for maintenance instructions.) If lab analysis shows coolant is unsuitable for continued use: Flush, drain, and refill. (Refer to <a href="#">Cooling System Maintenance</a> on page 225 for maintenance instructions.) Add ELC Extender (Refer to <a href="#">Cooling System Maintenance</a> on page 225 for maintenance instructions.)</li> <li>• Flush, drain, and refill with new coolant. (Refer to <a href="#">Cooling System Maintenance</a> on page 225 for maintenance instructions.)</li> </ul>
<p>Cooling - Fan clutch</p> <ul style="list-style-type: none"> <li>• Check for air leaks. (Refer to <a href="#">Engine Fan</a> on page 245 for maintenance instructions.)</li> <li>• Check the fan drive bearings (turn the sheave in both directions to check for worn hub bearings). (Refer to <a href="#">Engine Fan</a> on page 245 for maintenance instructions.)</li> </ul>
<p>Cooling - Solenoid valve</p> <ul style="list-style-type: none"> <li>• Check the fan drive for proper engagement and disengagement. (Refer to <a href="#">Engine Fan</a> on page 245 for maintenance instructions.)</li> </ul>
<p>Power Steering - Reservoir</p> <ul style="list-style-type: none"> <li>• Check the fluid level. (Refer to <a href="#">Power Steering Fluid</a> on page 265 for maintenance instructions.)</li> </ul>

<sup>20</sup> Ensure that all maintenance intervals leading up to this point are repeated during this interval prior to the completion of those listed here.

Every 15,000 mi / 24,000 km / 12 mo <sup>20</sup>
<p>Power Steering - Steering gear</p> <ul style="list-style-type: none"> <li>• Check the lash of the sector shaft; adjust as required. (Refer to <a href="#">Steering System</a> on page 264 for maintenance instructions.)</li> <li>• Grease the trunnion bearing (EP NLGI #2 lithium-based, moly-filled, HD grease). (Refer to <a href="#">Steering System</a> on page 264 for maintenance instructions.)</li> <li>• Grease the input shaft seal (EP NLGI #2 lithium-based, moly-filled, HD grease). (Refer to <a href="#">Steering System</a> on page 264 for maintenance instructions.)</li> </ul>
<p>Power Steering - Power assist cylinder</p> <ul style="list-style-type: none"> <li>• Lubricate the ball joints. Inspect for leaking rod seals, damaged ball joint boots, and damage to cylinder rod or barrel. (Refer to <a href="#">Steering System</a> on page 264 for maintenance instructions.)</li> </ul>
<p>Power Steering - Hoses and tubes</p> <ul style="list-style-type: none"> <li>• Check for leaks and chafing. (Refer to <a href="#">Steering System</a> on page 264 for maintenance instructions.)</li> </ul>
<p>Power Steering - Steering linkage</p> <ul style="list-style-type: none"> <li>• Check all joints for excessive lash; replace as required. (Refer to <a href="#">Steering System</a> on page 264 for maintenance instructions.)</li> </ul>
<p>Power Steering - Draglink tube clamp and ball socket</p> <ul style="list-style-type: none"> <li>• Check the torque; tighten to specified torque value as required. (Refer to <a href="#">Steering System</a> on page 264 for maintenance instructions.)</li> </ul>
<p>Power Steering - Pitman arm clamp bolt and nut</p> <ul style="list-style-type: none"> <li>• Check the torque; tighten to specified torque value as required. (Refer to <a href="#">Steering System</a> on page 264 for maintenance instructions.)</li> </ul>

<sup>20</sup> Ensure that all maintenance intervals leading up to this point are repeated during this interval prior to the completion of those listed here.

Every 15,000 mi / 24,000 km / 12 mo <sup>20</sup>
<p>Power Steering - Steering intermediate shaft</p> <ul style="list-style-type: none"> <li>• Check the torque on the pinch bolt and nut. (Refer to <a href="#">Steering System</a> on page 264 for maintenance instructions.)</li> </ul>
<p>Power Steering - Steering intermediate shaft U-joints (ON HIGHWAY)</p> <ul style="list-style-type: none"> <li>• Lubricate [EP NLGI #2 HD grease, +325° F to -10° F (+163° C to -23° C) range]. (Refer to <a href="#">Steering System</a> on page 264 for maintenance instructions.)</li> </ul>
<p>Power Steering - Steering intermediate shaft U-joints (OFF HIGHWAY or CITY DELIVERY)</p> <ul style="list-style-type: none"> <li>• Lubricate [EP NLGI #2 HD grease, +325° F to -10° F (+163° C to -23° C) range]. (Refer to <a href="#">Steering System</a> on page 264 for maintenance instructions.)</li> </ul>
<p>Power Steering - Draglink and tie rod arm ball sockets (ON HIGHWAY)</p> <ul style="list-style-type: none"> <li>• Lubricate (EP NLGI #2 lithium-based, moly-filled, HD grease). (Refer to <a href="#">Steering System</a> on page 264 for maintenance instructions.)</li> </ul>
<p>Power Steering - Draglink and tie rod arm ball sockets (OFF HIGHWAY or CITY DELIVERY)</p> <ul style="list-style-type: none"> <li>• Lubricate (EP NLGI #2 lithium-based, moly-filled, HD grease). (Refer to <a href="#">Steering System</a> on page 264 for maintenance instructions.)</li> </ul>
<p>Fuel and Tanks - Fuel tank breathers</p> <ul style="list-style-type: none"> <li>• Check for proper function; clean the drain hoses. (Refer to <a href="#">Fuel Tank</a> on page 250 for maintenance instructions.)</li> </ul>
<p>Driveshafts - Models SPL-140XL/170XL/250XL slip members and U-joints (OFF HIGHWAY and CITY)</p> <ul style="list-style-type: none"> <li>• Lubricate *.</li> </ul>

<sup>20</sup> Ensure that all maintenance intervals leading up to this point are repeated during this interval prior to the completion of those listed here.

Every 15,000 mi / 24,000 km / 12 mo <sup>20</sup>
Cab structure, doors and hoods - Hinges and latch <ul style="list-style-type: none"> <li>Lubricate with silicone spray.</li> </ul>
Cab structure, doors and hoods - Body and cab holddown bolts <ul style="list-style-type: none"> <li>Check the condition and tightness.</li> </ul>
Heating and Air Conditioning - Heater and air conditioner <ul style="list-style-type: none"> <li>Full operational and diagnostic check. (Refer to <a href="#">Heater and Air Conditioner Maintenance</a> on page 255 for maintenance instructions.)</li> </ul>
Heating and Air Conditioning - Condenser <ul style="list-style-type: none"> <li>Clear any debris from the front of the condenser. (Refer to <a href="#">Heater and Air Conditioner Maintenance</a> on page 255 for maintenance instructions.)</li> </ul>

**Every 60,000 mi / 96,000 km / 6 mo**

Every 60,000 mi / 96,000 km / 6 mo <sup>21</sup>
Steer Axle Wheel Ends - Steer Axle Oil Bath (Adjusted) with Synthetic Lubricant

Every 60,000 mi / 96,000 km / 6 mo
<ul style="list-style-type: none"> <li>Use SAE 75W-140, SAE 50L: See Oil Bath for maintenance instructions.</li> </ul>

<sup>20</sup> **Ensure that all maintenance intervals leading up to this point are repeated during this interval prior to the completion of those listed here.**

\* Use only Spicer Driveshaft approved lubricants when greasing Spicer U-joints.

<sup>21</sup> **Ensure that all maintenance intervals leading up to this point are repeated during this interval prior to the completion of those listed here.**

Every 60,000 mi / 96,000 km / 6 mo <sup>21</sup>
Steer Axle Wheel Ends - Steer Axle Oil Bath (Adjusted) with Mineral Base Lubricant <ul style="list-style-type: none"> <li>Use SAE 75W, 75W-90, 75W140, 80W-90, 85W-140: See Oil Bath for maintenance instructions.</li> </ul>
Steer Axle Wheel Ends - Steer Axle Semi-Fluid (Adjusted) with Semi-Fluid Synthetic Grease

Every 60,000 mi / 96,000 km / 6 mo
<ul style="list-style-type: none"> <li>Use Delo SF, Mobil SHC 007: See PACCAR 20K Front Axle Lubrication</li> </ul>
Steer Axle Wheel Ends - Steer Axle Grease Pack (Adjusted) with Heavy-Duty Multipurpose Lithium Base <ul style="list-style-type: none"> <li>#2 Grade: See PACCAR 20K Front Axle Lubrication</li> </ul>

Every 60,000 mi / 96,000 km

5

Every 60,000 mi / 96,000 km <sup>22</sup>
Power Steering System - Fluid and Filter Change <ul style="list-style-type: none"> <li>It is extremely difficult for an owner-operator to change the fluid or filter of the Power Steering Reservoir in an environmentally responsible manner without specialized tools and training. Have your power steering system serviced at an authorized service center or dealership.</li> </ul>
Driveshafts - Models SPL- 140/140HD/170/170HD/250/250HD slip members and U-joints (ON HIGHWAY and LINEHAUL) <ul style="list-style-type: none"> <li>Lubricate *</li> </ul>

<sup>21</sup> Ensure that all maintenance intervals leading up to this point are repeated during this interval prior to the completion of those listed here.

<sup>22</sup> Ensure that all maintenance intervals leading up to this point are repeated during this interval prior to the completion of those listed here.

<b>Every 60,000 mi / 96,000 km <sup>22</sup></b>
Air - Air dryer (OFF HIGHWAY)
<ul style="list-style-type: none"> <li>• Overhaul. (Refer to <a href="#">Air Dryer Maintenance</a> on page 206 for maintenance instructions.)</li> </ul>

**Every 120,000 miles /193,000 km / 2 yr**

**Steer Axle Wheel Ends**

<b>Every 120,000 miles /193,000 km / 2 yr <sup>23</sup></b>
Steer Axle Oil Bath LMS with Synthetic Lubricant
<ul style="list-style-type: none"> <li>• Use SAE 75W-90: See Oil bath for maintenance instructions.</li> </ul>
Air Intake - Pre-cleaner Filter Assembly

<b>Every 120,000 miles /193,000 km / 2 yr</b>
<ul style="list-style-type: none"> <li>• Install new Pre-cleaner Filter Assembly. (Refer to <a href="#">How to Remove the Pre-cleaner Filter</a> on page 247.)</li> </ul>
Main and Auxiliary Transmission - (PACCAR 8 Speed Transmission) (ON HIGHWAY)
<ul style="list-style-type: none"> <li>• Drain lubricant while warm. Flush each unit with clean flushing oil.</li> </ul>

## Fender Liners

The fender liners are located on both sides of the hood underside and protect the headlight assembly and other engine bay content from water and debris. Some maintenance processes require one or both liners to be removed.

### How to Remove a Fender Liner

Performed with hood open ([How to Open the Hood](#) on page 15) standing on either side of hood.

1. Unlock all four liner fasteners by twisting each ¼ turn counter-clockwise.

<sup>22</sup> **Ensure that all maintenance intervals leading up to this point are repeated during this interval prior to the completion of those listed here.**

\* Use only Spicer Driveshaft approved lubricants when greasing Spicer U-joints.

<sup>23</sup> **Ensure that all maintenance intervals leading up to this point are repeated during this interval prior to the completion of those listed here.**

2. Gently pull liner up and away from hood to remove.
3. Place fender liner aside.

**How to Reinstall a Fender Liner**

Performed with hood open (*How to Open the Hood* on page 15) standing on appropriate side of hood.

1. Hook bottom of liner to inside hood, below the headlight assembly.
2. Replace fender liner in hood, lining up locking fasteners.  
*Align hood guide with groove on liner: "LOCATE TO HOOD REINFORCEMENT."*
3. Gently insert then twist all four locking fasteners ¼ turn clockwise to secure liner.

**Lubricants**

Schedule service more frequently if you are operating under severe conditions such as extreme heat or cold, with very heavy loads, off-road, etc. For any special service requirements, consult your service manuals and your lubricant supplier. Please remember: one key to keeping your

truck running at top economy and prolonging its life is proper lubrication servicing. Neglecting this essential aspect of vehicle care can cost time and money in the long run.

 <b>WARNING</b>
Handle lubricants carefully. Vehicle lubricants (oil and grease) can be poisonous and cause sickness, personal injury, or death. They can also damage the paint on the vehicle.

 <b>CAUTION</b>
DO NOT mix different types of lubricants. Mixing lubricants (oil and grease) of different brands or types could damage vehicle components; therefore, drain (or remove) old lubricants from the unit before refilling it.

**Engine**

Proper engine lubrication depends on the outside temperatures where you will be driving. Use the oil recommended for the conditions you are most likely to be operating in. You will find a complete

engine lubrication service guide in the Engine Operation Manual that came with your vehicle. The engine operator manual contains specific maintenance tasks that you or a qualified service technician need to perform to maintain the engine.

 <b>WARNING</b>
Exhaust fumes from the engine contain carbon monoxide, a colorless and odorless gas. DO NOT breathe the engine exhaust gas. A poorly maintained, damaged, or corroded exhaust system can allow carbon monoxide to enter the cab. Entry of carbon monoxide into the cab is also possible from other vehicles nearby. Failure to properly maintain your vehicle could cause carbon monoxide to enter the cab, resulting in personal injury or death.



**WARNING**

Never idle your vehicle for prolonged periods of time if you sense that exhaust fumes are entering the cab. Investigate the cause of the fumes and correct it as soon as possible. If the vehicle must be driven under these conditions, drive only with the windows open. Failure to repair the source of the exhaust fumes may result in death, personal injury, equipment or property damage.



**NOTE**

Keep the engine exhaust system and the vehicle's cab ventilation system properly maintained. It is recommended that the vehicle's exhaust system and cab be inspected (1) By a competent technician every 15,000 miles (24,140 km); (2) Whenever a change is noticed in the sound of the exhaust system; or (3) Whenever the exhaust system, underbody, or cab is damaged.



**NOTE**

Use only an exact replacement DPF in exhaust systems. Using a noncompliant DPF as a replacement could violate these standards and also void the emission system's warranty.

**Driveline Universal Joints**

Refer to the Spicer Universal Joints and Driveshafts service manual and lubrication specifications.

**Non-PACCAR Transmissions, Axles and Hubs**

For all non-PACCAR brands, see the manufacturer's operator's manual for recommended lubrication specifications and maintenance intervals.

**Checking Oil Level**

For oil reservoir with side filler plugs (transmission, axles, steering gear boxes, transfer cases, etc.) the oil must be level with the filler opening. Use care when checking the oil level with a finger. Just because you can reach the oil level with a

finger does not mean the oil level is correct.

Improper Oil Level



Correct Oil Level



**Main transmission**

**Oil Changes**



**CAUTION**

When adding oil, types and brands of oil should not be intermixed because of possible incompatibility, which could decrease the effectiveness of the lubrication or cause component failure.

An initial oil change and flush should be performed after the transmission has been placed in actual service. This change



should be made any time after 3000 miles (4800 km) but never longer than 5000 miles (8000 km) of over-the-road service. In off-highway use, the change should be made after 24 hours but before 100 hours of service have elapsed.

**Refilling**

Remove all dirt around filler plug. Refill with new oil of the grade recommended for the existing season and prevailing service. Fill to the bottom of the level testing plug positioned on the side of the transmission. Do not overfill the transmission. Overfilling usually results in oil breakdown due to excessive heat and aeration from the churning action of the gears. Early breakdown of the oil will result in heavy varnish and sludge deposits that plug up oil ports and build up on the splines and bearings. Overflow of oil can also escape onto clutch or parking brakes. When adding oil, do not mix different types of oil.

**Fuller Transmission Lubrication**

Fuller transmissions are designed so that the internal parts operate in a bath of oil

circulated by the motion of gears and shafts. Grey iron parts have built-in channels where needed to help lubricate bearings and shafts. All parts will be amply lubricated if these procedures are closely followed:

1. Maintain oil level; check it regularly.
2. Change oil regularly.
3. Use the correct grade and type of oil.
4. Buy oil from a reputable dealer.

**Lubrication Change and Inspection Off-Highway Use**

Refer to the Eaton Fuller transmission manual for servicing information.

**Highway Use**

- Refer to the Eaton Fuller transmission manual for servicing information.
- Refer to the oil change vs. temperature chart that follows for special oil change information. The "intermittent peak temperature" is the maximum temperature

observed for a short time in a fully loaded vehicle performing normally.

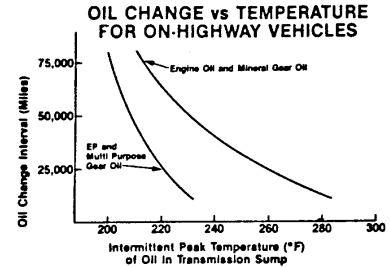

**CAUTION**

Exceeding the recommended oil change intervals may be harmful to the life of the transmission and the transmission oil cooler.

**Recommended Lubricants**

Type	Grade (SAE)	Ambient Temperature
Heavy Duty Engine Oil MIL-L-2104B, C, or D; API - SF, or API-CD	50	Above 10° F (-12° C)
	40	Above 10° F (-12° C)
	30	Below 10° F (-12° C)
Mineral gear oil with rust and oxidation inhibitor API-GL-1	90	Above 10° F (-12° C)
	80W	Below 10° F (-12° C)
Synthetic Lubricant*	50	All

**Allison Transmission Lubrication**

- Refer to your transmission manual (furnished separately) for lubrication information.

- Refer to the Allison Transmission manual for servicing information.

**PACCAR 8 Speed Lubrication**

**Recommended Lubricants**

Type	Grade (SAE)	Ambient Temperature
ZF-ECONFLUID LIFE PLUS		@ 100°C oil sump temp./mixed route

\* See your dealer for approved brands.

**Meritor Axle Lubrication**

	<p><b>NOTE</b></p>
<p>Axles utilized in 100% off-highway use are not eligible for Meritor's Advanced Lube Rear Drive Axle program.</p>	

Under Meritor's Advanced Lube Rear Drive Axle program, the axles listed below are exempt from an initial lubricant change:

**Available Advanced Lube Axles**

RS-19-145	RS-26-180	RT-40-145P	RT-46-160
RS-21-145	RS-30-180	SQ-100A	RT-46-160P
RS-23-160	RT-34-145	SQ-100AP	RT-52-160
RS-23-161	RT-34-145P	RT-44-145	RT-52-160P
RS-17-145	RS-23-180	RT-40-145	RT-44-145P

Meritor rear axles that do not appear on the list above will continue to require an initial drain at 3,000-5,000 miles (4,800-8,000 km).

- Refer to the *Meritor Field Maintenance Manual* for a particular axle for lubricant specifications.
- See your dealer for Meritor-approved lubricant brands.
- Refer to the following chart for lubricant change intervals:

Application	Type Of Lubricant	Mileage Interval
On Highway	Synthetic	240,000 mi. (384,000 km)
	Synthetic with Pump and Filter	500,000 mi. (800,000 km)
	Mineral Base	120,000 mi. (192,000 km)
City Delivery	Synthetic	120,000 mi. (192,000 km)
	Synthetic with Pump and Filter	240,000 mi. (384,000 km)
	Mineral Base	120,000 mi. (192,000 km)
Off Highway	Synthetic	120,000 mi. (192,000 km)
	Synthetic with Pump and Filter	120,000 mi. (192,000 km)
	Mineral Base	120,000 mi. (192,000 km)

- Change the lubricant filter every 120,000 miles (192,000 km). Top off the lubricant level with a similar lubricant

**Eaton/Dana Axle Lubrication**

- The original mineral-based lubricant must be drained within 3,000-5,000 miles (4,800-8,000 km) on all Eaton axles. This initial change is very important because it

flushes out break-in contaminants that might otherwise cause premature wear.

- No initial drain is required on Eaton axles that are factory filled with an Eaton-approved synthetic lubricant.
- Mineral-based lubes must be drained within the first 5,000 miles (8,000 km) if converting to an Eaton-approved synthetic lube.

- Change the lubricant within the first 5,000 miles (8,000 km) of operation after a carrier head replacement, regardless of the lubricant type.
- Refer to the *Eaton Field Maintenance Manual* for a particular axle for lubricant specifications.
- See your dealer for Eaton-approved lubricant brands.
- Refer to the chart below for lubricant change interval.

Type of Lubricant	On-Highway Mi. (km)	Maximum Change Interval	On/Off Highway Severe Service Mi. (km)	Maximum Change Interval
Mineral-Based	120,000 (192,000)	Yearly	60,000 (96,000)	Yearly
Eaton-Approved Synthetic	240,000 (384,000)	2 Years	120,000 (192,000)	Yearly
Eaton-Approved Synthetic in axle with extended drain interval option	350,000 (560,000)			

**Wheel Bearing Lubrication**

**Oil-lubricated Driven Hubs**

Use hypoid oil, A.P.I.-GL-5 SAE 75W-90FE synthetic gear lubricant or equivalent. A minimum of 1 quart (921 ml) of oil is required for proper lubrication of each drive hub. Add oil through the filler hole in the hub; if none, add oil through the differential filler hole.

	<b>NOTE</b>
Remember to replace vent plug or threaded filler plug when done.	

Allow time for the oil to seep through the bearings when initially filling a hub. Maintain the differential oil level by adding oil until its surface is even with the bottom of the filler hole (see illustration in [Checking Oil Level](#) on page 198).

**Oil-lubricated Nondriven Hubs**

Use hypoid oil, A.P.I.-GL-5 SAE 75W-90FE synthetic gear lubricant or equivalent. A minimum of 1 quart (921 ml) of oil is required for proper lubrication of each drive hub. Add oil through the filler hole in the hub; if none, add oil through the differential filler hole.

	<b>NOTE</b>
Remember to replace vent plug or threaded filler plug when done.	

Allow time for the oil to seep through the bearings when initially filling a hub. Maintain the differential oil level by adding oil until its surface is even with the bottom of the filler hole (see illustration in [Checking Oil Level](#) on page 198).

**Inspect Power Steering Fluid**

Access the power steering reservoir in the engine compartment. Take all safety precautions when opening the hood.



**CAUTION**

When adding fluid, be sure to use fluid of the same type. While many fluids have the same description and intended purpose, they should not be mixed due to incompatible additives. Mixing incompatible fluids may lead to equipment damage.

1. Turn engine off and open hood.
2. Wipe outside of power steering reservoir cover so that no dirt can fall into the reservoir.
3. Verify that the fluid level is at the correct level. Add more fluid if required.
4. Check fluid for air bubbles which may indicate contamination, discoloration, or burnt smell; correct source of such problems before replacing fluid and filter.

If incompatible (insoluble) fluids are mixed in a power steering system, air bubbles can be produced at the interface of the two fluids. This can cause cavitation, which reduces the lubrication between moving parts in the gear. This could result in worn components. The mixture of two different

fluids, although harmless to individual internal components, may initiate a chemical reaction that produces a new compound that will attack seals and other internal components. **DO NOT** mix different fluids.

## Air System

The operation of the vehicle's braking system and many vehicle accessories depends upon the storage and application of a high-pressure air supply.



**WARNING**

**DO NOT** attempt to modify, alter, repair or disconnect any component of the air system. Repairs or modifications to the air system, other than what is described in this section, should only be performed by an authorized dealer. Failure to comply may result in personal injury or death.



**WARNING**

Prior to the removal of any air system component, always block and hold the vehicle by a secure means other than the vehicle's own brakes. Depleting air system pressure may cause the vehicle to roll unexpectedly resulting in an accident causing personal injury or death. Keep hands away from chamber push rods and slack adjusters, they may apply as system pressure drops.



**WARNING**

After completing any repairs to the air system, always test for air leaks and check the brakes for safe operation before putting the vehicle in service. Failure to comply may result in property damage, personal injury, or death.

 **WARNING**

Never connect or disconnect a hose or line containing air pressure. It may whip as air escapes. Never remove a component or pipe plug unless you are certain all system pressure has been depleted. Failure to comply may result in property damage, personal injury, or death.

 **WARNING**

Never exceed recommended air pressure and always wear safety glasses when working with air pressure. Never look into air jets or direct them at anyone. Failure to comply may result in property damage, personal injury, or death.

 **WARNING**

Never attempt to disassemble a component until you have read and understood recommended procedures. Some components contain powerful

springs and injury can result if not properly disassembled. Use only proper tools and observe all precautions pertaining to use of those tools. Failure to comply may result in property damage, personal injury, or death.

 **WARNING**

Completely bypassing a Bendix® AD-IS air dryer will bypass the system's pressure protection valves. This could lead to loss of air pressure or damage to the vehicle's air system, which could cause an accident involving death or personal injury. Always adhere to the manufacturer's procedure if it is necessary in an emergency to temporarily bypass an AD-IS series air dryer. Failure to comply may result in death, personal injury, equipment or property damage.

 **WARNING**

If a different air dryer brand or model is installed on the vehicle other than what was originally installed, it could

cause the air system to not perform correctly unless the full air system design is reviewed and modifications made to comply with Federal Motor Vehicle Safety Standards (FMVSS) 121 AirBrake Systems. Failure to abide by this warning and maintain compliance to FMVSS 121 could cause loss of vehicle control and may lead to death or serious personal injury.

 **WARNING**

If the supply and service air tanks are not drained at the recommended frequency, water could enter the air lines and valves. This could cause corrosion or blockage, which could compromise the brake system safety and potentially cause an accident. Failure to comply may result in property damage, personal injury, or death.

Your vehicle's compressor takes outside air and compresses it, usually to 100-120 psi (689-827 kPa). The compressed air then goes to the reservoirs to be stored until needed. When you operate your air brakes, the stored compressed air flows

into the chambers where it is used to apply your truck and trailer brakes. That is why, when you push down on your brake pedal, you don't feel the same amount of pressure on the pedal that you do when you apply the brakes on your car. All you are doing on your truck is opening an air valve to allow air to flow into the brake chambers. Contamination of the air supply system is the major cause of problems in air-operated components such as brake valves, and suspension height control valves. To keep contaminants to the lowest possible level, follow these maintenance procedures.

**Daily Checks**

- Drain moisture from the supply and service air tanks.
- Operate air devices to circulate lubricant within the unit.

**Periodically**

- Clean filter screens ahead of the valves by removing the screens and soaking them in solvent. Blow them dry with pressurized air before reinstalling them.

**Twice a Year**

- Maintain the air compressor to prevent excessive oil bypass. See your maintenance manual for details.
- Replace worn seals in valves and air motors as needed.

**Dual Air System Function Test**

Conduct this test at least every 3 months or if there is any indication of a potential problem.

Park the vehicle on level ground and block the wheels. Have an assistant open drain valves and, where required, observe brake action at the wheels. If a malfunction occurs during this test, do not move the vehicle until the problem has been corrected. Engine should be Off with the key switch to the ON or RUN position.



**NOTE**

Tractor air system must be connected to trailer.

**Air Dryer Maintenance**



**NOTE**

Because no two vehicles operate under identical conditions, maintenance and maintenance intervals will vary. Experience is a valuable guide in determining the best maintenance interval for any one particular operation.



**NOTE**

A small amount of oil in the system may be normal and should not, in itself, be considered a reason to replace the desiccant cartridge. Oil stained desiccant can function adequately.

Every 900 operating hours or 25,000 miles (40,000 km) or every 3 months check for moisture in the air brake system by opening air tanks, drain cocks, or valves and checking for presence of water. A tablespoon of water found in the air tank would point to the need for a desiccant cartridge change. However, the following conditions can also cause water



accumulation and should be considered before replacing the desiccant cartridge.

- Air usage is exceptionally high and not normal for a highway vehicle. This may be due to accessory air demands or some unusual air requirement that does not allow the compressor to load and unload (compressing and non-compressing cycle) in a normal fashion or it may be due to excessive leaks in the air system.
- In areas where more than a 30°F (17°C) range of temperature occurs in one day, small amounts of water can accumulate in the air brake system due to condensation. Under these conditions, the presence of small amounts of moisture is normal and should not be considered as an indication that the dryer is not performing properly.
- An outside air source has been used to charge the air system. This air did not pass through the drying bed.

### Maintenance

 <b>CAUTION</b>
<p>Replace oil-coalescing desiccant air dryer cartridge every 1 year regardless of mileage. Only use oil-coalescing desiccant replacement cartridge when replacing. Failure to perform this maintenance task will void the PACCAR Transmission warranty and may result in expensive transmission damage.</p>

Replace (non-oil-coalescing) desiccant cartridge:

- On-highway operation replace every 2-3 years, 350,000 miles (560,000 km) or 10,800 hours.
- High duty cycle usage such as transit bus, refuse hauler, dump truck, cement mixers and off-highway operation replace every 1 year, 100,000 miles (160,000 km) or 3,600 hours.



### NOTE

Review the warranty policy before performing any maintenance procedures. An extended warranty may be voided if unauthorized maintenance is performed during this period.

### **Bendix® AD-HF Series Air Dryer**

Your vehicle may be equipped with a Bendix® AD-HF series air dryer. Any air dryer replacement should be made with an identical component.



**WARNING**

Use of an air dryer brand or model that differs from what was originally installed could cause the air system to not perform correctly unless the full air system design is reviewed and modifications are made to comply with Federal Motor Vehicle Safety Standard (FMVSS) 121 Air Brake Systems. Failure to abide by this warning and maintain compliance with FMVSS 121 could cause loss of vehicle control and may lead to serious personal injury or death.

The AD-HF Series air dryer has incorporated into its design various components that have typically been installed separately on the vehicle (see below for components/areas affected):

- Pressure protection valves
- Safety valve
- Solenoid valves and plumbing
- Plumbing of the front and rear service air tanks
- Plumbing to accessory systems

These components are required to meet the Federal Motor Vehicle Safety

Standards (FMVSS 121 - Air Brake Systems). As the Warning above states, any other type of air dryer installed in the place of an AD-HF Series will require changes, modifications and/or additions to your vehicle's air system to maintain compliance with FMVSS 121.

**Air Tanks**



**WARNING**

If the supply and service air tanks are not drained at the recommended frequency, water could enter the air lines and valves. This could cause corrosion or blockage, which could compromise the brake system safety and potentially cause an accident. Failure to comply may result in property damage, personal injury, or death.



**CAUTION**

DO NOT use penetrating oil, alcohol, brake fluid, or wax-based oils in the air system. These fluids may cause se-

vere damage to air system components.

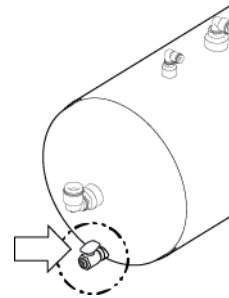

To eject moisture from the air system tanks, pull the line that is connected to the moisture ejection valve. Continue pulling until the air comes out free of water.

**Daily**

The supply and service air tanks, must be drained on a daily basis. Operate air devices daily to circulate lubricants within the unit.

**Periodically**

Clean filter screens ahead of the valves by removing the screens and soaking them in

solvent. Blow them dry with pressurized air before reinstalling them.

- Maintain the air compressor to prevent excessive oil bypass
- Replace worn seals in valves and air motors as they are needed. Your authorized dealer carries rebuild kits for most units

### Air Gauges and Air Leaks

**WARNING**

DO NOT operate the vehicle if leakage in the air system is detected. Conduct the following procedure and contact an authorized dealer (or any other properly equipped service center) if a leak is detected. Failure to check the brakes or follow these procedures could cause a system failure, increasing the risk of an accident and may result in

personal injury, property damage, or death.

If your vehicle is equipped with air brakes, it has two separate, additional air systems: Primary and Secondary. Each air system is monitored by a gauge indicating system pressure in either pounds per square inch (psi), and/or kilopascals (kPa). The Primary gauge indicates pressure in the rear braking system:

Primary Air Pressure Gauge



The Secondary gauge indicates pressure in the front braking system:

Secondary Air Pressure Gauge



The Primary and Secondary Air Pressure gauges are shown in the Primary Gauges View on the Digital Display.<sup>24</sup>

At start-up, the Primary and Secondary Air Pressure gauges may indicate red, and the Low Air System Pressure alarm may sound until the minimum operational pressure setpoint of 65 psi (448 kPa) is reached.<sup>25,26</sup> If the tanks are empty, this can take up to two minutes. If these gauges

- Remain red
- Turn red
- Indicate below 65 psi (448 kPa)

Or the Low Air System Pressure Alarm

- Turns on
- Does not turn off

do not attempt to drive the vehicle until the problem is found and fixed: system pressure is too low for normal brake operation.

<sup>24</sup> The model 520 Right-hand Stand-up uses additional physical gauges for Primary and Secondary Air Pressure.  
<sup>25</sup> The model 520 Right-hand Stand-up also indicates low air pressure using a warning light in the physical gauges.  
<sup>26</sup> The Low Air System Pressure alarm is not active when the engine is off.



**NOTE**

Park brakes lock up at 60 psi (414 kPa), the audible alarm will sound at 65 psi (448 kPa).

**How to Check the Compressed Air System for Leaks**



**WARNING**

DO NOT operate the vehicle if leakage in the air system is detected. Conduct the following procedure and contact an authorized dealer (or any other properly equipped service center) if a leak is detected. Failure to check the brakes or follow these procedures could cause a system failure, increasing the risk of an accident and may result in personal injury, property damage, or death.

Use this procedure to check the compressed air system due to the following:

- After maintenance

- When an air system component is replaced
- When a leak is suspected
- Periodically, to ensure system integrity

To check for Air System leaks

1. Start the engine if not already running.
2. **Scroll** to the Primary Gauges View to monitor Primary and Secondary Air Pressures.

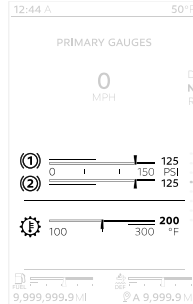

3. Build up air pressure in the system until the system cutout setpoint or until 120 psi (827 kPa) is reached.
4. Turn the Ignition Switch to OFF (stopping the engine) and then back to the ON position, but don't start the engine.

The Primary Gauges View will appear.

5. Release the service brakes, and observe the rate of air pressure drop. This rate should not exceed 2.0 psi (14 kPa) per minute.
6. Start the engine and build up air pressure again.
7. Turn the Ignition Switch to OFF (stopping the engine) and then back to the ON position, but don't start the engine.
8. Apply the brakes fully, holding the pedal down for five minutes. The pressure drop should not exceed 3.0 psi (21 kPa) per minute.
9. If you detect excessive leakage (air pressure loss greater than 3.0 psi (21 kPa) after five minutes of brake application), a leakage test should be made at the air line connections and at all air brake control units. These tests should determine where air is escaping.

**Air Compressor**

All compressors, regardless of make or model, run continuously while the engine is

running. System pressure is controlled by the governor. The governor acts in conjunction with the unloading mechanism in the compressor cylinder block to start and stop compression of air. The compressor is unloaded when the system pressure reaches 120 psi (827 kPa) and compression is reestablished when system pressure falls to 100 psi (690 kPa).

### Preventive Maintenance

The following service checks are provided for your information only and should be performed by a certified mechanic. Contact your dealer or the engine manufacturer's Maintenance Manual for further information on servicing air compressors. After completing any repairs to the air system, always test for air leaks, and check the brakes for safe operation before putting the vehicle in service. Below is a list of areas to maintain for the air compressor:

- Inspect compressor air filter element, if so equipped, and replace element if clogged. Check compressor mounting and drive for alignment and belt tension. Adjust if necessary.
- Remove compressor discharge valve cap nuts and check for presence of excessive carbon. If

excessive carbon is found, clean or replace the compressor cylinder head. Also, check compressor discharge line for carbon, and clean or replace the discharge line if necessary.

- Disassemble compressor and thoroughly clean and inspect all parts. Repair or replace all worn or damaged parts, or replace compressor with a factory exchange unit.

## Brake System

To learn more about brakes, see the Index, under Brakes.



### WARNING

DO NOT work on the brake system without the parking brake set and wheels chocked securely. If the vehicle is not secured to prevent uncontrolled vehicle movement, it could roll and cause damage to the vehicle, serious personal injury, or death.



### CAUTION

The air brake system of this vehicle was configured for ONE of the following operations: tractor or truck, and complies with the respective portions of FMVSS 121. A tractor shall not be operated or configured as a truck, nor shall a truck be operated or configured as a tractor, without significant modifications to the air brake system in order to retain compliance with FMVSS 121. Contact your dealer for instructions.



### WARNING

DO NOT use brake linings with a thickness below the specified minimum. Such linings will have lining rivets exposed that can damage the brake drum and reduce brake efficiency, which could cause death, personal injury or system failure.



**WARNING**

DO NOT use any replacement part in the brake system unless it conforms exactly to original specifications. A nonconforming part in your vehicle's brake system could cause a malfunction resulting in an accident causing death or personal injury. Sizes and types are so related to one another that a seemingly unimportant change in one may result in a change in how well the brakes work for you on the road. If parts do not work together properly, you could lose control of your vehicle, which could cause a serious accident.

Brake adjustment and brake balance must be set carefully to (1) make the most efficient use of the forces available for braking and (2) allow equal stopping forces at all wheels. Once a brake system is set to specifications, changing any one of its components or any combination of components may cause the system to not work as well. All parts have to work together to perform as they should. Any replacement components in your brake system should be exactly equal to the

original components. Any changes from the original specifications can affect the whole system. All of the following areas are interrelated and must conform to original specifications:

- Tire size
- Drum brakes
- Cam radius
- Wedge angle
- Drum radius
- Brake linings
- Brake chambers
- Slack adjusters
- Disc brakes
- Disc rotors

All vehicle operators should check their brakes regularly.

**Air Disc Brakes**

Have brake pads inspected by a qualified mechanic for wear at regular intervals according to the [Preventive Maintenance Intervals](#) on page 173. In severe service or off-highway applications inspect the linings more frequently.

Regularly inspect for pad/rotor wear:

- Park on level ground and chock the wheels.

- Temporarily release the parking brakes.
- Compare the relative position of two notches; one located on the caliper and the other on the carrier. See the illustration below to determine if the brakes require a detailed inspection by a qualified mechanic.
- Have a qualified mechanic perform a detailed inspection if the notches are not found. The pads and rotors should be measured and compared against the manufacturers specifications located in the brake manufacturer's service manual.

Caliper Detail

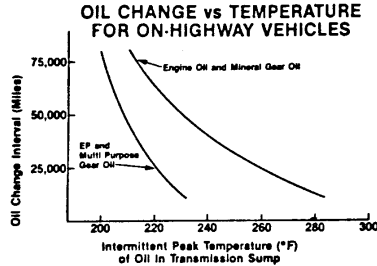

1. Brake Caliper Assembly
2. Location of Inspection Grooves
3. Notches Line-Up (Time to schedule inspection of Pads and Rotors)
4. Brake Rotor
5. Brake Carrier Assembly

Regularly inspect caliper for Running Clearance:

- Stop the vehicle on level ground and let the brakes cool down. Hot brake calipers can burn skin on contact.
- Chock the wheels.

- Temporarily release the parking brakes.
- Grab the caliper and move it. This movement is Running Clearance.
- Proper Running Clearance is 0.08 inch (2 mm) of movement of the brake caliper (approximately the thickness of a nickel) in the inboard/outboard direction.
- Have a qualified mechanic provide further inspection if the caliper does not move or appears to move more than the specified clearance.

### Operational Checks of Automatic Slack Adjusters

- Measure brake chamber stroke with the spring brake released and the air pressure no less than 100 psi (690 kPa).
- Brake Chamber Stroke is the difference between the applied and the retracted position of the air chamber pushrod.
- A correctly installed and functioning auto slack adjuster will produce the following strokes:

Chamber Type	Stroke
36 (rear brakes)	1-1/2" - 2-1/4" (38 - 57 mm)
30 (rear brakes)	1-1/2" - 2" (38 - 51 mm)
16, 20 & 24 (front brakes)	1" - 1-3/4" (25.4 - 44.4 mm)

Brake Chamber Stroke

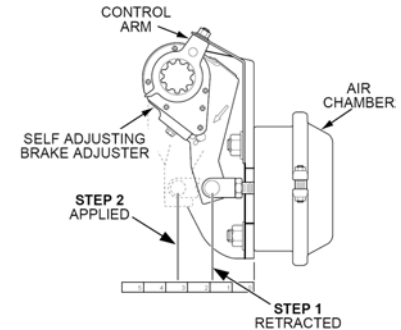



**WARNING**

Manual adjustment of automatic slack adjusters is a dangerous practice that could have serious consequences. It gives the operator a false sense of security about the effectiveness of the brakes. Contact the Service Department at your dealership if the stroke exceeds specifications. A stroke exceeding specifications may indicate a problem with the slack adjuster or the brake foundation.

2. Apply pressure to the brake pedal and measure the distance the air chamber pushrod traveled.
3. Compare the results to the specification to determine if the automatic slack adjusters need replacing.



**WARNING**

Manual adjustment of automatic slack adjusters is a dangerous practice that could have serious consequences. It gives the operator a false sense of security about the effectiveness of the brakes. Contact the Service Department at your dealership if the stroke exceeds specifications. A stroke exceeding specifications may indicate a problem with the slack adjuster or the brake foundation.

**Automatic Slack Adjuster Stroke Specification**

Chamber Type	Stroke
36 (rear brakes)	1.5-2.5 in. (38-57 mm)
30 (rear brakes)	1.5-2 in. (38-51 mm)
16, 20 and 24 (front brakes)	1-1.75 in. (25.4-44.4 mm)

**Hydraulic Brake System**

To operate your vehicle safely, you need some understanding of its brake systems. Brake adjustment and brake balance must be set carefully to allow equal stopping forces at all wheels. Tires are also a very important part of the whole system. How fast you can stop depends on how much friction there is between the road and your tires.

All of the following areas are interrelated and must conform to original specifications:

- wheel size
- tire size
- brake pads

**Drum Brake Inspection**

Have brake drum linings inspected by a qualified mechanic for wear at regular intervals according to the maintenance schedule. In severe service or off-highway applications inspect the linings more frequently. In addition, periodically check the brake chamber stroke. Replace the slack adjuster if proper stroke cannot be maintained.

Operational checks of automatic slack adjusters

1. Start the vehicle and get the air system up to normal operating



- brake rotors
- front wheel bearings
- front end alignment
- parking brake drum radius

Once a brake system is set to specifications, changing any one of its components or any combination of components may degrade the system. All parts have to work together to perform as they should. Your brake system is hydraulically operated. Refer to [Service Brake Component Inspection](#) on page 216 for more information on inspecting the brakes. Any replacement components in the brake system must meet the specifications of the original components. Any changes from the original specifications can affect the performance of the entire system.

 **WARNING**

Do not use any replacement part in the brake system unless it conforms exactly to original specifications. A non-conforming part in your vehicle's brake system could cause a malfunction resulting in an injury accident. Consult

your local dealer for suitable replacement parts.

 **WARNING**

Do not work on the brake system without the parking brake set, the keys removed from the vehicle, and wheels chocked securely. If the vehicle is not properly secured to prevent inadvertent vehicle movement, it could roll and cause serious personal injury or damage to the vehicle.

- Use wood blocks (4 in. X 4 in. X 6 in. or larger) against the front and rear surfaces of the tires. Be sure the vehicle cannot move.

**Brake Fluid Check and Refill**

 **WARNING**

Wear protective clothing when handling hydraulic fluid. It is mildly toxic and can cause skin and eye irritation.

 **WARNING**

Use only the type of hydraulic fluid specified. Do not use or mix different types of hydraulic fluid. The wrong hydraulic fluid will damage the rubber parts of the brake system which may lead to loss of braking and possibly cause serious personal injury.

 **CAUTION**

Hydraulic brake systems use two distinct and incompatible fluids. Power steering fluid is used in the hydraulic brake booster system. Brake fluid is used in the master cylinder and brake pipes. Do not mix these fluids when replenishing the system or seal damage can result.

 **CAUTION**

Hydraulic brake fluid may damage painted surfaces of the vehicle.

Make sure that the fluid level registers on or above the fluid level mark molded on the reservoir - add more if necessary, as follows:

1. Remove each reservoir cap and extract the rubber diaphragm from each reservoir.

**Booster and Master Cylinder Assembly**

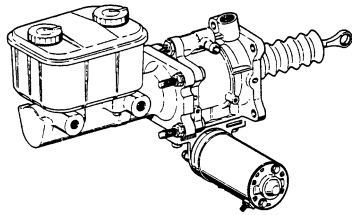

2. Fill each reservoir with clean hydraulic fluid of the approved specification (DOT 3 brake fluid).
3. Insert the rubber diaphragms into the reservoirs.
4. To prevent leakage from the reservoirs, ensure that the seal in each reservoir cap is in good condition before refitting the cap.



**WARNING**

If the brake fluid reservoir requires an excessive amount of hydraulic fluid, the complete system must be inspected for leaks and repaired if necessary (consult your nearest dealer). Failure to keep the brake system in good repair may lead to loss of braking and possibly cause serious personal injury.



**CAUTION**

When replacing disc brake pads, be sure to use the same lining material on both axles. Mixing lining types can result in unbalanced braking, increased pad wear, or degraded stopping performance. Consult your nearest dealer.

**Disc brake pads**

Visually inspect all brake pad linings. Brake pads should be replaced when the remaining lining reaches 3.16 inch thickness or less. It is recommended that all disc brake pads be replaced at the same time since this will maintain balanced braking. At a minimum, replace all disc brake pads on one axle, both ends, at the same time.

**Calipers**

Visually inspect calipers for brake fluid leakage, damaged or defective pistons or piston boots. If there is evidence of leakage, damage, or other defects the caliper should be replaced or repaired.

**Disc brake rotors**

Visually inspect rotors for scoring, warping, cracks, bluing or heat spots or other damage or defects. If signs of damage or defects are found, the rotor(s) should be resurfaced or replaced in accordance with the vehicle manufacturer's recommended service procedure.

**Anchor plates**

Visually inspect anchor plates for worn or damaged slippers, damaged or dislodged

**Service Brake Component Inspection**

Remove each wheel to inspect the brake components.

**System Components**

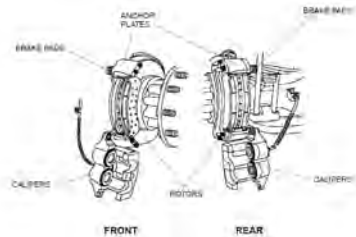

guide pin boots or other defects. If signs of wear, damage or defects are found, the anchor plate(s) should be repaired or replaced.

### Parking Brake Component Inspection

**i** NOTE

If you are not properly trained to perform brake inspections or service, take your vehicle to your nearest dealer.

Visually inspect brake shoe lining for wear, cracks, or breakage. If linings are worn down to 2.5 mm (0.10 in), they must be replaced. Inspect brake drum for deep scores, heat spots, cracks, or damage. Replace if needed.

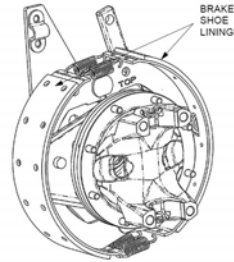

### Cab Maintenance

Cab exterior, interior, frame and engine compartment components need maintenance to ensure longevity and safe operations. A clean vehicle also allows leaks to be detected easier.

**! WARNING**

Always allow hot surfaces to cool down before attempting to work near them. Failure to comply may result in personal injury or death.

**! WARNING**

Handle cleaning agents carefully. Cleaning agents may be poisonous. Keep them out of the reach of children. Failure to comply may result in property damage, personal injury, or death.

**! WARNING**

DO NOT use gasoline, kerosene, naphtha, nail polish remover or other volatile cleaning fluids. They may be toxic, flammable or hazardous in other ways. Failure to comply may result in personal injury, property damage or death.

**! WARNING**

DO NOT clean the underside of chassis, fenders, wheel covers, etc. without protecting your hands and arms. You may cut yourself on sharp edged metal parts. Failure to comply may result in personal injury, property damage, or death.



**WARNING**

Moisture, ice, and road salt on brakes may affect braking efficiency. Test the brakes carefully after each vehicle wash. Failure to comply may result in death, personal injury, equipment or property damage.

**Vehicle Cleaning**

- Observe all caution labels
- Always read directions on the container before using any product
- Do not use any solution that can damage the body paint
- Most chemical cleaners are concentrates that require dilution
- Only use spot removing fluids in well ventilated areas
- Any vehicle is subjected to deterioration from multiple causes (i.e. industrial fumes, ice, snow, corrosive road salt, etc.,)

**Exterior and Engine Compartment**

Corrosive materials used to remove ice, snow and dust from the road can collect on the entire vehicle with concentrated

accumulations throughout the underbody and engine compartment. If these materials are not removed, accelerated corrosion (rust) can occur on underbody parts such as fuel lines, frame rails, floor pan, electrical and exhaust system, even though they have been provided with corrosion protection.

At least every spring, flush these materials from the entire vehicle, including the underbody and engine compartment, with plain water using light water pressure. On vehicles used in applications and/or areas that experience high usage of, or exposure to, corrosive materials, cleaning of the entire vehicle should be done more frequently. If desired, your dealer can do this service for you.



**CAUTION**

Do not direct high pressure water onto seals or flexible hoses. Water may enter the part which will contaminate the system lubricants and fluids. To prevent damage to these components, keep a gentle flow of water moving at all times. Failure to comply may result in equipment damage.



**CAUTION**

Do not direct high pressure water onto electrical components, plug connectors, seals or flexible hoses on the engine. Failure to comply can accelerate corrosion and degrade electrical component which may cause a fire or equipment damage.

To prevent rust, keep chromed parts clean and protected with wax at all times, especially in winter conditions when the roads are salted.

- If necessary, use a commercial chrome cleaner to remove light rust.
- Chrome surfaces are best cleaned with fresh water. Wipe dry to preserve their luster. A commercial chrome cleaner will remove light rust. After cleaning, wax flat surfaces and apply a thin coat of rust preventive lubricant around bolts or other fasteners.
- Clean aluminum wheels and bumpers with cool water. Tar-remover will get rid of heavy deposits of road grime. To prevent

spotting, wipe aluminum surfaces dry after washing.

- Under corrosive conditions, such as driving on salted roads, clean aluminum parts with steam or high-pressure water from a hose. A mild automotive soap solution will help. Rinse thoroughly.

To maintain the tailpipe's quality finish, wash the tailpipe with a soft cloth, mild automotive soap, and water or glass cleaner. A non-abrasive chrome polish can be used sparingly on hard-to-clean areas. DO NOT clean your high-heat chrome using scouring pads, abrasive chrome polish, highly acidic chemical cleaners or any other abrasive cleaners. Even high quality stainless steel parts can rust under prolonged exposure to salt water, especially when the salt-laden moisture is held against the metal surface by road grime. It is important to frequently clean salty moisture and grime from stainless steel surfaces.

- If surface rust is encountered, wash the surface and use a commercial polishing compound to clean off the rust, followed by a coating of wax.
- Never use steel wool when cleaning stainless steel. Minute

particles of the steel wool can become embedded in the surface of the stainless steel part and cause rust staining.

### Weather Stripping

Frequent washing of the vehicle is required to remove road grime and contaminants that can stain and oxidize paint and accelerate corrosion of plated and polished metal surfaces. Waxing offers added protection against staining and oxidation. Do not apply wax in the hot sun and do not friction burn the paint with a buffing machine. Occasionally spray weather-stripping on doors and windows with silicone compound to help preserve resiliency. This is especially useful in freezing weather to prevent doors and windows from sticking shut with ice.

	<p><b>NOTE</b></p>
<p>To allow enough time for your truck's finish to cure, wait at least thirty days after the date of manufacture before waxing.</p>	

### Cleaning Interior Vinyl and Upholstery

	<p><b>NOTE</b></p>
<p>Strong cleaning agents such as hand sanitizer, solvents, paint thinners, window cleaner and gasoline/ diesel fuel must never be used on your vehicle's interior. Repeated exposure to chemicals such as sunscreen, insect repellents containing DEET, or brake fluid may cause accelerated wear, tackiness or discoloration of interior surfaces.</p>	

Wipe vinyl upholstery and lining with a good commercial upholstery cleaner. Do not use acetone or lacquer thinner. Clean fabric upholstery with upholstery shampoo specially formulated for this purpose.

- First remove loose dirt, dust or debris with a vacuum cleaner.
- Use a soft brush to loosen caked-on dirt before vacuuming it away.
- Wipe the fabric surface with a slightly damp cloth and dry the seat fabric thoroughly. If the fabric is still dirty, wipe using a mixture of mild

soap and lukewarm water, then dry thoroughly.

- If the stain does not come out use an upholstery shampoo specially formulated for this purpose. Test the cleaner on a hidden place to make sure it does not harm the fabric. Follow the instructions on the container.

Other interior surfaces may be cleaned using a mixture of mild soap and lukewarm water, or an automotive interior cleaner, used on its intended surface (i.e. use leather conditioner on leather surfaces, etc.).

Avoid frequent or repeated use of the following products on interior surfaces:

- Alcohol-based cleaners (including hand sanitizer)
- Methanol-based cleaners
- Bleach
- Acetone
- Any other strong solvent
- Abrasive cleaners
- Sunscreen

### How to Wash the Exterior of the Vehicle

Your dealer has a number of vehicle-care products and can advise you on which ones to use for cleaning the exterior and interior of your vehicle.



#### WARNING

Handle cleaning agents carefully. Cleaning agents may be poisonous. Keep them out of the reach of children. Failure to comply may result in property damage, personal injury, or death.



#### WARNING

DO NOT use gasoline, kerosene, naphtha, nail polish remover or other volatile cleaning fluids. They may be toxic, flammable or hazardous in other ways. Failure to comply may result in personal injury, property damage or death.



#### WARNING

DO NOT clean the underside of chassis, fenders, wheel covers, etc. without protecting your hands and arms. You may cut yourself on sharp edged metal parts. Failure to comply may result in personal injury, property damage, or death.



#### WARNING

Moisture, ice, and road salt on brakes may affect braking efficiency. Test the brakes carefully after each vehicle wash. Failure to comply may result in death, personal injury, equipment or property damage.



**CAUTION**

DO NOT aim the water jet directly at door locks or latch. Tape the key holes to prevent water from seeping into the lock cylinders. Water in lock cylinders should be removed with compressed air. To prevent locks from freezing in the winter, squirt glycerin or lock deicer into the lock cylinders.



**NOTE**

To allow enough time for your truck's finish to cure, wait at least thirty days after the date of manufacture before waxing.

1. Begin by spraying water over the dry surface to remove all loose dirt before applying the car wash solution.



**CAUTION**

Do not direct high pressure water onto seals or flexible hoses. Water may en-

ter the part which will contaminate the system lubricants and fluids. To prevent damage to these components, keep a gentle flow of water moving at all times. Failure to comply may result in equipment damage.



**CAUTION**

Do not direct high pressure water onto electrical components, plug connectors, seals or flexible hoses on the engine. Failure to comply can accelerate corrosion and degrade electrical component which may cause a fire or equipment damage.

- Do not wash the vehicle in direct sunshine.
  - Do not spray water directly into the cab vents.
2. Using soapy water, wash the vehicle with a clean soft cloth or a soft brush made for automotive cleaning.
  - Use cool water and a mild, automotive-type soap. Strong industrial detergents, cleaning agents and household-type soaps are not recommended



**CAUTION**

Do not direct high pressure water onto seals or flexible hoses. Water may enter the part which will contaminate the system lubricants and fluids. To prevent damage to these components, keep a gentle flow of water moving at all times. Failure to comply may result in equipment damage.

- Do not use stiff brushes, paper towels, steel wool, or abrasive cleaning compounds because they will scratch painted, plated, and polished metal surfaces.
3. Rinse painted surfaces with gentle water pressure frequently while washing to flush away dirt that might scratch the finishes during the washing operation.
  4. Hose dirt and grime from the entire chassis.



**CAUTION**

Do not direct high pressure water onto electrical components, plug connectors, seals or flexible hoses on the engine. Failure to comply can accelerate corrosion and degrade electrical component which may cause a fire or equipment damage.

5

5. Wipe everything dry with a chamois to avoid water spots. To prevent water spotting, dry off the cosmetic surfaces with a clean cloth or chamois.
6. Remove road tar with an automotive-type tar remover or mineral spirits.
7. After cleaning and drying the entire vehicle, apply a quality automotive wax to protect the vehicle's finish.

**Cab HVAC Fresh Air Filter Replacement**

The fresh air filter for the cab HVAC is located in the air intake housing that is mounted to the firewall in the passenger side rear corner of the engine

compartment. The filter can be replaced without using any tools.

1. Tilt the hood open.
2. Locate the air intake housing at the passenger side rear corner of the engine bay, below the rain tray.

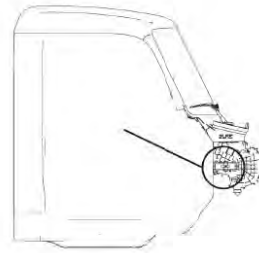

3. Locate the filter cover labeled "OPEN" with an arrow pointing towards the rear of the vehicle. Slide the filter cover towards the rear of the vehicle, until you are able to remove the cover.

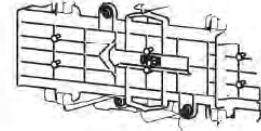

4. Remove and inspect the filter, referring to the maintenance interval schedule.
5. Install the new air filter into its housing, taking care to align the airflow direction indicated on the filter element with the airflow direction that's marked on the air intake housing.
6. Replace the filter cover on the air intake housing and slide the cover toward the front of the vehicle. An audible "snap" sound can be heard when the cover is correctly installed. If the snap feature is damaged there are two screw features that may be used to secure the cover.
7. Close and secure the vehicle's hood.



### Care of Display Screens on the Dashboard

To clean the screen, dampen a clean, soft, lint-free cloth with water only. A mild glass cleaner that does not contain alcohol or ammonia may also be used. Cleaners that contain alcohol and/or ammonia will eventually dry-out, crack and "yellow" the screen. Wipe the screen gently back and forth. You can also use a commercial cleaner especially designed for LCD screens.

### Safety Restraint System - Inspection

#### WARNING

Failure to properly inspect and maintain restraint systems can lead to injury or loss of life. Without periodic inspection and maintenance to detect unsafe conditions, seat restraint components can wear out or not protect you in an accident.

#### WARNING

It is important to remember that any time a vehicle is involved in an accident, the entire seat belt system must be replaced. Unexposed damage caused by the stress of an accident could prevent the system from functioning properly the next time it is needed. Failure to comply may result in death or personal injury.

#### Seat Belt Inspection Points

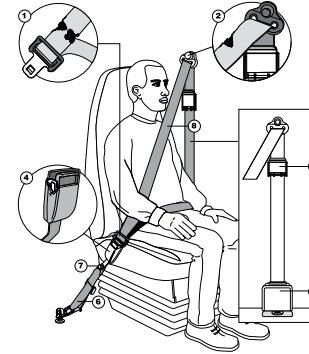

1. Web cut or frayed or extremely worn at latch area
2. Web cut or frayed at D-loop web guide
3. Comfort Clip cracked or damaged
4. Buckle casting broken
5. Retractor Web Storage for damage (located behind trim panel)
6. Tethers for web wear and proper tightness of mounting hardware

7. Mounting hardware for corrosion, proper tightness of bolts and nuts
8. Web for deterioration, due to exposure to the sun

Factors contributing to reduced seat belt life:

- Heavy trucks typically accumulate twice as many miles as the average passenger car in a given time period.
- Seat and cab movement in trucks causes almost constant movement of the belt due to ride characteristics and seat design. The constant movement of the belt inside the restraint hardware and the potential for the belt to come in contact with the cab and other vehicle parts, contributes to the wear of the entire system.
- Environmental conditions, such as dirt and ultraviolet rays from the sun, will reduce the life of the seat belt system.

Due to these factors, the three-point safety belt system installed in your vehicle requires thorough inspection every 20,000 miles (32,000 km). If the vehicle is exposed to severe environmental or working conditions, more frequent inspections may

be necessary. Any seat belt system that shows cuts, fraying, extreme or unusual wear, significant discoloration due to UV (ultraviolet) exposure, abrasion to the seat belt webbing, or damage to the buckle, latch plate, retractor hardware, or any other obvious problem should be replaced immediately, regardless of mileage.

### Inspection Guidelines

Follow these guidelines when inspecting for cuts, fraying, extreme or unusual wear of the webbing, and damage to the buckle, retractor, hardware, or other factors. Damage to these areas indicates that belt system replacement is necessary.

 <b>WARNING</b>
<p>Replace the entire belt system (retractor and buckle side) if replacement of any one part is necessary. Unexposed damage to one or more components could prevent the system from functioning properly the next time it is needed. Failure to comply may result in death or personal injury.</p>

1. Check the web wear in the system. The webbing must be closely

examined to determine if it is coming into contact with any sharp or rough surfaces on the seat or other parts of the cab interior. These areas are typical places where the web will experience cutting or abrasion. Cuts, fraying, or excessive wear would indicate the need for replacement of the seat belt system.

2. The pillar web guide (D-loop) is the area where almost constant movement of the seat belt webbing occurs because of relative movement between the seat and cab.
3. Check the Komfort Latch for cracks or possible damage and check for proper operation.
4. Check buckle and latch for proper operation and to determine if latch plate is worn, deformed, or damaged.
5. Inspect the retractor web storage device, which is mounted on the floor of the vehicle, for damage. The retractor is the heart of the occupant restraint system and can often be damaged if abused, even unintentionally. Check operation to ensure that it is not locked up and

- that it spools out and retracts webbing properly.
6. If tethers are used, be sure they are properly attached to the seat and, if adjustable, that they are adjusted in accordance with installation instructions. Tethers must also be inspected for web wear and proper tightness of mounting hardware.
  7. Mounting hardware should be evaluated for corrosion, and for tightness of bolts and nuts.
  8. Check web in areas exposed to ultraviolet rays from the sun. If the color of the web in these areas is gray to light brown, the physical strength of the web may have deteriorated due to exposure to the sun's ultraviolet rays. Replace the system.

Once the need for replacement of the seat belt has been determined, be certain it is only replaced with an authorized PACCAR Parts replacement seat belt. If the inspection indicates that any part of the seat belt system requires replacement, the entire system must be replaced. An installation guide is attached to every replacement belt. Utilize the proper guide for your type of seat, and follow the

instructions very closely. It is vitally important that all components be reinstalled in the same position as the original components that were removed and that the fasteners be torqued to specification. This will maintain the design integrity of the mounting points for the seat belt assembly. Contact your dealer if you have any questions concerning seat belt replacement.

## Cooling System Maintenance

The cooling system in your vehicle was factory filled with extended life coolant that meets or exceeds all ASTM D6210 and Caterpillar EC-1 requirements. PACCAR recommends only using a 50:50 mixture of distilled water and ELC when cooling system service is required. A 50:50 mixture of ELC and distilled water will provide freeze protection down to -34°F (-36.7°C), which is adequate for most locations in North America. For extremely cold operating conditions, a 60:40 mixture (coolant/water ratio) can be used to provide freeze protection down to -62°F (-52.2°C).

Unless otherwise optioned, factory fill coolant is an ethylene glycol, nitrated organic acid technology (NOAT) extended life coolant (ELC) formulation at a 50:50 coolant-to-distilled water mixture. The factory fill exceeds ASTM D6210 and Caterpillar EC-1 requirements. Maintaining coolant chemistry and freeze protection is critical to engine and cooling system component health and longevity.



### WARNING

Coolant is toxic. DO NOT get the fluid in eyes. If contact occurs, flood eyes with large amounts of water for 15 minutes. Avoid prolonged or repeated contact with skin. In case of contact, immediately wash skin with soap and water. DO NOT take internally. If swallowed, seek immediate medical attention. DO NOT induce vomiting. Failure to comply may result in death, personal injury, equipment or property damage.



**CAUTION**

The engine cooling system has very specific maintenance and inspection requirements. Failure to follow requirements can damage the engine. Engine damage can include but is not limited to freezing, boiling, corrosion, pitted cylinder liners. This information is found in the engine manufacturers owner's manual. It is the owner's responsibility to follow all requirements listed in the engine manufacturers owner's manual.



**CAUTION**

Use of non-genuine PACCAR coolant filters can cause severe engine damage.

**Concentration**

Check the level of freeze/boil-over protection, which is determined by the glycol concentration. Use a glycol refractometer to determine glycol level. Add coolant to obtain the coolant/water ratio required to provide the protection you need. A 50:50 mix of coolant and water is adequate for most applications. For extremely cold operating conditions, the ratio can be adjusted to a higher concentration of coolant.



**NOTE**

Coolant is harmful to the environment. Unused coolant must be stored as a toxic hazardous material in leakproof containers. Used coolant must be processed as industrial chemical waste. Please follow HAZMAT guidelines with both used and unused coolants.



**NOTE**

Maximum recommended ELC concentration is 60% ELC and 40% water by volume (a 60:40 coolant mixture). The minimum recommended concentration is 40%.

**Glycol Concentration Level**

Level	Desired Coolant / Water Ratio	Freeze Point °F (°C)
Recommended Levels	40%	-12 (-24)
	45%	-23 (-31)
	50%	-34 (-37)
	55%	-50 (-46)
	60%	-62 (-52)

**Condition**

Perform a visual inspection of the coolant. It should have no cloudiness or floating debris. Determine the chemical inhibitor concentration level by using an extended life coolant specific test kit or test strips. Inhibitor concentration level determines corrosion protection. If you are concerned about possible coolant quality, contamination, or mechanical problems, submit a coolant sample for analysis. Improper maintenance may cause coolant

degradation and could result in damage to the cooling system and engine components. Consult your dealer or the coolant manufacturer's representative for recommended extended life coolant test kits, test strips, and laboratory sample procedures.

### Coolant Extender

Add extended life coolant extender, if necessary, according to the corrosion inhibitor concentration required. DO NOT add coolant extender to nitrite-free coolant.

### Checking Coolant Level

Check the coolant level daily. When adding coolant, avoid mixing different brands and formulations. If the coolant is mixed with more than 25% of a different formulation, engine corrosion damage could occur. If mixing exceeds 25% of total system volume, it is recommended to flush and refill the system completely with one type of coolant.

### Coolant Filter

Your engine may be equipped with a coolant filter. It is a "blank filter" and does not contain chemicals or time-release additives. Replace it only with a blank filter at the interval specified in your engine's

operator's manual. Never use filters that contain supplemental coolant additives (SCAs) in an ELC-filled system. Consult your engine operator's manual for information on the coolant filter and service procedures.



### CAUTION

Use of non-genuine PACCAR coolant filters can cause severe engine damage.

### Cooling System Sealing Additives and Soluble Oils

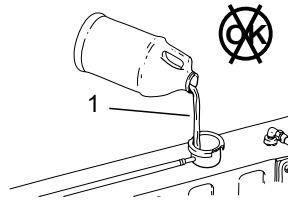

1. Do not use soluble oils or sealing additives.



### CAUTION

The use of sealing additives or soluble oils in the cooling system can cause damage to the engine. These additives can plug various areas of the radiator, EGR system and oil cooler. The plugging of the cooling system can hamper heat transfer, causing internal engine damage. DO NOT use sealing additives or soluble oils in the cooling system. The use of sealing additives can:

- Build up in coolant low-flow areas
- Plug the radiator and oil cooler
- Damage the water pump seal
- Damage heat transfer surfaces
- Damage seals and hoses
- Corrode brass and copper

Failure to comply may result in equipment or property damage.

### Inspect Coolant Level

Inspect the vehicle's coolant surge tank for proper coolant level. Add coolant if the level in the tank is below the line marked **MIN**.

The minimum fluid level is determined by the line on the surge tank indicated by the letters "MIN." This indicator is located below the fill cap. The cooling system will need to be filled if the level is not above the "MIN" line, regardless of engine temperature.

**Bulkhead Mounted Coolant Surge Tank**

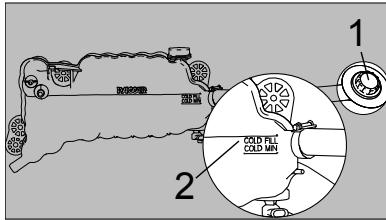

1. Fill location
2. Fill line

**Radiator Hoses**

Perform these maintenance procedures according to the Preventative Maintenance Schedule.

1. Check the following radiator hose conditions:
  - Deterioration/signs of leaking
  - Hose clamp torque

**How to Add Coolant to the Cooling System**

**WARNING**

DO NOT remove the coolant fill cap while the engine is hot. Scalding steam and fluid under pressure may escape and cause serious burns. Failure to comply may result in personal injury or death.

**NOTE**

If frequent topping off is necessary and there are no visible signs of coolant leaks when the engine is cold, check for leaks with the engine operating at normal temperature.

**NOTE**

DO NOT use the pressure cap to fill the surge tank with fluid.

**NOTE**

DO NOT overfill a cooling system. Excess coolant may result in overflow, loss of antifreeze, and reduced corrosion protection.

**Bulkhead Mounted Coolant Surge Tank**

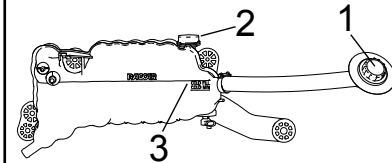

1. Fill cap and port (service point)
2. Pressure cap (never to be removed)
3. Fill line

1. Turn off the engine and let it cool for a minimum of 10 minutes.
2. If your cooling system is built with an air bleed valve in the upper engine coolant pipe, open the air

- bleed valve before filling the surge tank.
- 3. Close any open coolant drain valves in the lower engine coolant pipe.
- 4. Remove the surge tank fill cap (1), but DO NOT remove the surge tank pressure cap (2).
- 5. Fill the system with premixed coolant through the surge tank fill port. Pour coolant at a steady rate until it reaches the lower of the two lines indicated by either "COLD MIN" or "MIN" on the surge tank. Wait for one minute after adding coolant. If the coolant level drops, add coolant until it returns to the lower line.
- 6. Close the air bleed valve if opened in Step 2.
- 7. Start the engine and maintain an idle at a low rpm.
- 8. While the engine is idling air will purge from the cooling system via the surge tank's coolant fill port, which will lower the coolant level in the surge tank. Continue to fill the surge tank until the coolant level remains approximately 1/2 in. (13 mm) above the "MIN" line. This

- may take up to 2 minutes, depending on the outside temperature.
- 9. Maintain a low idle until the thermostat opens and the operating temperature stabilizes. A sign that the thermostat has opened is when the upper coolant pipe gets hot on the bottom side indicating hot coolant is now running through it.
- 10. Add coolant to the surge tank until the coolant remains 1/2 in. (13 mm) above the "COLD MIN" or "MIN" level.
- 11. Operate the engine at high idle for 10 minutes. Afterward, add coolant to the surge tank until the coolant remains 1/2 in. (13 mm) above the "COLD FULL" line.
- 12. Reinstall the surge tank fill cap (1).

### Windshield Wiper/Washer

The windshield wiper system is designed to be maintenance-free. Check wiper blades annually, every 60,000 miles (96,000 km), or when they begin to show signs of wear.

Check the washer reservoir water level daily, located in the engine compartment. If necessary, refill to the proper level.

### How to Refill the Washer Fluid Reservoir

	<b>CAUTION</b>
DO NOT use antifreeze or engine coolant in the windshield washer reservoir, damage to seals and other components will result.	

1. Park the vehicle and apply the parking brakes.
2. Open the hood and secure it in the open position.
3. Locate the washer fluid reservoir located on the driver's side of the engine compartment, behind the wheel, and open the filler cap.
4. Fill the 2.1 Gallon (7.9 Liter) reservoir with windshield washer fluid and replace the cap.
5. Close and secure the hood.

## Headlights

### Maintaining Headlight Performance



#### WARNING

LED replacement light sources are not approved for use in this headlamp and could result in a thermal event due to the highly focused internal optics. Damage caused by the use of LED light sources is not warrantable. Failure to comply may result in property damage, personal injury, or death.



#### NOTE

A headlight bulb is the brightest it will ever be when it is new, and becomes dimmer over time. A bulb that has been used for 100,000 miles is approximately half as bright as a new bulb. If you expect optimum performance, consider replacing your bulbs frequently. Keep a spare or even used bulb in the glove compartment and **never run with only**

one headlamp.



#### NOTE

Know what type of headlamps your vehicle is equipped with (Standard Incandescent, Halogen, or LED). For light bulb replacement types, refer to [Vehicle Light Bulb Specifications](#) on page 283.

### Headlight Features

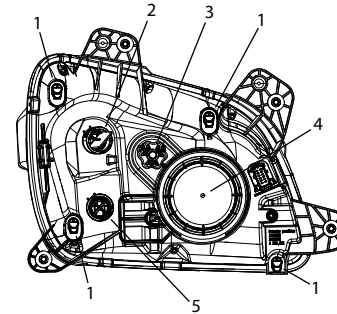

1. Vents - NON SERVICEABLE - (removal will destroy).
2. Turn signal/side marker bulb socket.
3. Headlight beam-angle adjustment knob.
4. High/Low beam main headlight bulb socket.
5. Daylight Running light (DRL) bulb socket.



- Fender liners and access caps must be re-installed after service to protect the headlamp from high pressure water spray and gravel bombardment.
- Lenses can be polished by a professional polishing service **not more than twice** before being replaced.
- The headlight assembly is equipped with filtered vents that allow for cooling of the bulbs and evacuation of water vapor. The filters are intended to keep insects out and are NOT serviceable because the caps that hold the filters will be destroyed if they are removed. Keep obstructions, or obstructing agents like mud, away from the vents.
- A discolored bulb (one that is other than clear) is an indication that it has overheated. It may perform poorly, be close to failure, and should be replaced as soon as possible.
- Headlight cover lenses should be cleaned with a mild, particulate-free, dish soap (e.g. Dawn, or Joy). The headlight should never be cleaned with an abrasive scouring

powder or soap, nor with petrochemicals like Gasoline or Diesel as these will break down the hard coating and cause crazing in the lens.

- Be aware that some truck loads can require re-aiming of the headlights by a trained technician due to a change in vehicle rake.
- If the cover lens is worn to the point that it is no longer transparent, but translucent or opaque, the headlight should be replaced.
- Bulbs should be replaced with a premium brand (e.g. Phillips, Osram, Sylvania, Federal-Mogul, or GE). Bulbs with the long life designation "LL" are recommended, but not required.
- The headlight covers are designed to withstand the force of wind, but cannot be used to push solid objects, or be pushed on, with significant force.
- When replacing a bulb, do not touch the globe with your fingers. Oil from human skin can focus the light locally, resulting in early bulb failure.

## How to Replace a Headlight Bulb

Each headlight assembly contains three bulbs:

- Low beam/high beam
- Daytime running light (DRL)/ parking light
- Turn signal/side marker/side turn.

Replacing a headlight bulb is accomplished by opening the hood and accessing the rear of the headlight (located behind a removable fender panel). See Vehicle Light Bulb Specifications for bulb replacement data.

1. Park the vehicle and apply the parking brake.
2. Open the hood and secure it in the open position (see How to Open the Hood).
3. Remove fender liner to access headlight assembly ([How to Remove a Fender Liner](#) on page 196).
4. Replace a headlight assembly bulb:  
When replacing the low beam/high beam bulb, the low beam/high beam socket cap must first be unscrewed and removed.

- a. Twist bulb socket counter-clockwise to loosen and remove socket and bulb from the headlight assembly.
- b. Change the bulb in the socket.
- c. Replace socket and bulb into headlight assembly by lining up the tab on the socket with the slot in the headlight housing and then insert.
- d. Twist socket clockwise to lock. Replace low beam/high beam socket cap if removed earlier in this step.

headlight reduces performance and creates glare.

**Aiming Headlights**

The headlights were properly aimed at the factory to meet safety specifications. If the headlights need to be adjusted, please have an authorized dealership aim the headlights.

should be performed by an authorized dealer. Improper repair or modifications will void your warranty and/or cause serious damage to your vehicle.

**Engine Aftertreatment System Power Requirements**

The engine aftertreatment system uses battery power for up to 10 minutes after the ignition is turned off. After the ignition turns off, the engine aftertreatment system circulates DEF to help cool down the fluid and prevent overheating. For situations where the battery will be disconnected (i.e. for service or maintenance of the vehicle), please wait 10 minutes before disconnecting battery power.

- 5. Reinstall fender liner ([How to Reinstall a Fender Liner](#) on page 197).
- 6. Close and secure hood (See Close the Hood).

**Final Checks**

- 1. After everything is reconnected, turn on your headlights and check for operation.
- 2. Have your headlights periodically checked for proper alignment by dealer.
- 3. Keep your headlights clean, using only clean soap and water. A dirty

**Electrical System**

 **WARNING**

Battery posts, terminals and related accessories contain lead and lead compounds, chemicals known to the State of California to cause cancer and reproductive harm. Wash hands after handling.

 **CAUTION**

DO NOT modify or improperly repair the vehicles electrical system or power distribution box. All electrical repairs

 **CAUTION**

Wait at least 10 minutes after the key switch is turned OFF before disconnecting battery power. The system uses battery power to circulate DEF and prevent overheating of the DEF system. Failure to comply may result in property damage.

### Low Voltage Disconnect (LVD) (option)

The Low Voltage Disconnect (LVD) may increase battery life and avoid depleting the battery below the minimum charge needed to start the engine by shutting off non-vital battery loads.

When battery voltage drops below the LVD setting, LVD starts a two-minute countdown. If battery voltage remains below the LVD setting and the engine is not started, when the countdown ends, all non-vital battery loads (hotel loads) will be shut off. The LVD setting is adjusted in the Settings sub-menu of the Digital Display. When battery voltage drops below the LVD setting

1. An amber LVD Popup notification occurs, accompanied by an audible warning. This starts the two-minute countdown.
2. Thirty seconds before the countdown ends, the Battery Voltage indicator is replaced by the amber (or red) LVD telltale<sup>27</sup>. The LVD popup notification will turn red and will be accompanied by a continuous audible warning.



3. When the two-minute countdown has ended, the LVD “Hotel Loads Disconnected” Popup appears, and LVD shuts off all loads connected through the LVD system.

The LVD condition will not clear until battery voltage increases above the LVD setting or the engine is started. Electrical loads shut off by LVD

- Cab dome lamps
- Cab accessories
- Spare LVD wiring for customer added accessories



#### WARNING

DO NOT use the Spare Battery A and B circuits or other circuits that are controlled by the LVD to power electronic engine controls, ABS circuits, or safe-

ty/work related lighting. Before adding any device to the vehicle's electrical system, consult your nearest authorized dealer or read the contents of TMC RP136. Failure to do so may cause equipment damage or lead to personal injury.



#### NOTE

The determination of what circuits/loads that were connected to the LVD was based upon the recommendation from Technology and Maintenance Council (TMC) of the American Trucking Association. To review the recommended practice, see TMC RP-136.



#### NOTE

All LVD circuits are color-coded blue on the central electrical panel cover label.

<sup>27</sup> On the 15 inch display, LVD telltale color depends on the severity of battery depletion.

### LVD Setup

Change the LVD battery voltage set point for LVD to turn on [Low Voltage Disconnect \(LVD\)](#) (option) on page 233.

### Fuses, Circuit Breakers and Relays

Fuses, circuit breakers, and relays are located in the Power Distribution Box to the left of the steering column behind the clutch pedal. Additional fuses for the alternator, engine electronics and trailer battery charge circuit may be located in the Power Distribution Center (PDC) inside the battery box and/ or on the engine side of the cab firewall.

### Adding Electrical Options



#### WARNING

Do not add a fuse with a rating higher than 30 amps. Follow the circuit protection size/type recommended by the component manufacturer. Installing a fuse or circuit breaker greater than designated may damage the electrical system which could lead to equipment damage and/or personal injury.



#### WARNING

Never install a circuit breaker/polyswitch in a location indicated for “fuse only.” Using a polyswitch (circuit breaker) in a fuse-only circuit may cause the circuit to overheat when a short exists, which could lead to equipment damage and/or personal injury.



#### NOTE

Polyswitches/circuit breakers are allowed in certain locations as indicated by the label on the fuse box. In these applications, a fuse may be used instead of a circuit breaker.



#### NOTE

Do not install a circuit breaker in place of a fuse for the following circuits:

- ACC FEED
- BODY IGN
- CAB ABS - BATT
- CAB ABS - IGN

- CAB ACC
- CB PWR
- CECU - BATT (2 PLCS)
- CECU IGN
- DOOR IGN
- ENG AUX
- ENG SD
- FOG LMPs
- GAUGE CL
- HIGH BEAM SUP
- LH DR / DOOR LOCK
- LOW BEAM SUP
- PARK LMP SNSE
- RADIO MEM
- RADIO PWR
- RH DOOR
- SLPR ACC
- RKE
- TRLR ABS
- TURN MOD PWR

Typical - See reverse side of Power Distribution Box cover for fuse and relay locations

### Maximum Number of Lamps Allowed per Circuit

- Vehicle Stop/Turn Signal Circuit

The lighting control unit is limited to 5 amps total, or two (2) 25 watt incandescent bulbs per side. Do not wire more than two incandescent bulbs per side to the vehicle tail lamp fixtures. If more than two bulbs are required for each tail lamp fixture, install LED type lamps, or contact your nearest authorized dealer for other options.

- Trailer Turn and Vehicle Forward Side Facing Turn Lamp Circuit

The lighting control unit is limited to 20 amps or nine (9) 25 watt incandescent bulbs total (per side) for the combination of trailer turn lamps and vehicle forward side facing turn lamps. Do not wire more than nine incandescent bulbs per side for the combination of trailer turn lamps and vehicle forward side facing turn lamps. If more than nine bulbs per side are required, install LED type lamps, or contact your nearest authorized dealer for other options.

 <b>CAUTION</b>
<p>Before installing additional vehicle stop/turn lamps, trailer turn lamps or additional forward side facing turn lamps on the vehicle, make sure the</p>

lighting circuit limits described above are not exceeded. Exceeding the number of lamps designated above can/will cause the electronic control unit to default to a protection mode, causing the lamps to not function properly.

Similar to the headlamp system, if a problem is detected with the electronic control unit, the control unit will cycle the turn signals off once every 9 seconds. You can detect that this is occurring if the turn signal indicators in the dash operate intermittently.

If you experience intermittent turn signal operation, the problem is either a short in the turn signal circuit or the maximum number of bulbs has been exceeded for the circuit.

If you experience any vehicle stop/turn signal issues, contact your nearest authorized dealer.

### Vehicle CAN Bus

Your vehicle is equipped with a CAN bus electrical system. Because of how the electrical system is designed it is important that any accessories added after the vehicle is built are installed only on the K-CAN or the S-CAN. These dedicated CANs

are provided on the driver's side of the cab, near to the interior fuse panel. Access to the K-CAN and S-CANs is provided by two RP1226 connectors. DO NOT tap into, connect to, tamper with, or splice into any CAN network other than the K-CAN or the S-CAN. Connecting to an unapproved CAN network may trigger CAN fault codes.

 <b>CAUTION</b>
<p>Connecting to an unapproved CAN network may trigger CAN fault codes. The manufacturer will not warrant failures or damage caused to CAN network components when the failure or damage is a result of improper connections to the CAN network.</p>



**CAUTION**

The use of scotch locks, scraped off insulation, and electrical tape are not approved CAN connection techniques. These are the source of numerous CAN faults.

Scotch locks

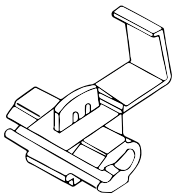

**Batteries**

Regular attention to the charging system will help prolong the service life of the batteries.



**WARNING**

Batteries contain acid that can burn and gases that can explode. Ignoring safety procedures may result in death, personal injury, equipment or property damage.



**WARNING**

Never remove or tamper with battery caps. Ignoring this could allow battery acid to contact eyes, skin, fabrics, or painted surfaces. Failure to comply may result in property damage, personal injury, or death.



**CAUTION**

DO NOT store other items in the battery box. Failure to comply could result in damage to the truck and/or batteries.



**CAUTION**

Properly secure battery tie downs and battery box cover when reinstalling batteries after service. DO NOT over tighten. Over tightening can crack the battery case which can lead to equipment damage.



**CAUTION**

The Diesel Exhaust Fluid (DEF) system recirculates fluid to the doser to prevent damage from heat after key off. If your vehicle is equipped with battery disconnect switches do NOT disconnect battery power within TEN minutes of switching the ignition key off. Failure to comply may result in vehicle or property damage.

Here are some common causes of battery failure:

Overcharge: this condition results from improper voltage regulator adjustment. It results in overheating of the battery, warped plates, and evaporation of electrolyte.

**Undercharge:** the voltage regulator is malfunctioning, the drive belt is slipping, or your vehicle has undergone long periods of idling or short distance driving. These conditions result in battery plates becoming covered with a hard coating.

**Vibration:** loose battery hold-downs may cause battery plate failure.

**Short Circuits:** these discharge the battery by draining electricity.

**Dirty or Loose Connections:** improper connections may stop the flow of electrical power to and from the battery.

### Battery Charging



#### WARNING

Batteries can injure you severely. They contain acid, produce poisonous and explosive gases, and supply levels of electric current high enough to cause burns. A spark or flame near a battery on charge may cause it to explode with great force. Never remove or tamper with the battery caps. Failure to comply may result in property damage, personal injury, or death.

Except for using small trickle charges to maintain battery condition, you should

have your vehicle's batteries charged by a qualified service facility. To help reduce the risk of personal injuries, follow these guidelines carefully when recharging a battery:

- Before attempting any service in the electrical installation, disconnect the battery negative cable.
- Allow no sparks or open flame anywhere near the charging area.
- Charge a battery only in a well-ventilated area, such as outdoors or in a fully open garage which contains no pilot lights or other flames. Gases generated during the charging process must be allowed to escape.
- Always make sure the battery charger is OFF before connecting or disconnecting the cable clamps.
- To avoid short circuits, damage to the vehicle, or personal injury, never place metal tools or jumper cables on the battery or nearby. Metal that accidentally comes in contact with the positive battery terminal or any other metal on the vehicle (that is in contact with the

positive terminal), could cause a short circuit or an explosion.

### Charging Reminders

- Use protective eyewear
- Keep all batteries away from children
- Never reverse battery poles
- Never attempt to place the vehicle in motion, or run the engine with batteries disconnected
- Keep the battery clean and dry
- Look for any signs of damage
- Battery terminals should not be coated with improper grease. Use a commercially available, noncorrosive, non-conductive terminal coating, or petroleum jelly.
- Never use a fast charger as a booster to start the engine. This can seriously damage sensitive electronic components such as relays, radio, etc., as well as the battery charger. Fast charging a battery is dangerous and should only be attempted by a competent mechanic with the proper equipment.

### Under Cab Battery Access

The battery compartment is located on the left side of the vehicle, under the cab access steps.

1. Remove steps by removing 2 bolts from each step.
2. Remove 4 bolts and washers from forward fairing.
3. Remove 2 bolts (A) from step strut.
4. Remove battery cover for access.

### In Cab Battery Access

Your vehicle may be equipped with Absorbed Glass Mat (AGM) batteries located in the cab under the passenger's seat. The glass mat in AGM batteries are designed to absorb the battery acid inside the battery that can leak or spill out in conventional batteries. This design feature allows batteries to be positioned in any orientation without risk of leaking.

To access the batteries:

1. Enter the cab.
2. Remove six fasteners securing the passenger side seat base to the battery box assembly.
3. Remove the seat and seat base as one unit to gain access to the batteries.

4. Installation is the reverse of removal.

### Cranking Battery Specification

Category	Specification
Group	31
Stud Type	Threaded
Cold Crank Amps	650
Voltage	12 V
Reserve Capacity	160 minutes
General	Maintenance free

### Removing Batteries

After accessing the batteries, follow these steps to remove them from the vehicle.



#### CAUTION

Wait at least 10 minutes after the key switch is turned OFF before disconnecting battery power. The system

uses battery power to circulate DEF and prevent overheating of the DEF system. Failure to comply may result in property damage.

1. Be sure all switches on the vehicle are turned OFF
2. Wait 10 minutes after turning ignition off before disconnecting the batteries
3. Disconnect negative (-) ground cable first
4. Disconnect positive (+) cable
5. Unscrew the holding plate bolts with an open end wrench



#### NOTE

Always dispose of automotive batteries in a safe and responsible manner. Contact your authorized dealer for disposal standards. Call your local authorized recycling center for information on recycling automotive batteries.

Follow the procedures below to reinstall batteries on the vehicle and replace parts removed for access.



### Installing Batteries

Follow the procedure below to reinstall main batteries on the vehicle:

 **NOTE**

Always dispose of automotive batteries in a safe and responsible manner. Contact your authorized dealer for disposal standards. Call your local authorized recycling center for information on recycling automotive batteries.

 **NOTE**

Make sure to reconnect the ground (negative) cable last.

 **WARNING**

Battery replacement may alter or disturb battery cable routing. Check to insure battery cables are free from any point of chaffing. Failure to comply may result in death, personal injury, equipment or property damage.

1. Place batteries in vehicle and tighten bolt of holding plate
2. Reconnect positive cable
3. Reconnect ground (negative) ground cable

### Replace Battery Box Cover

 **WARNING**

Always reinstall steps before entering the cab or accessing the deck plate. Without steps you could slip and fall. Failure to comply may result in personal injury or death.

 **WARNING**

Fairings not installed properly could come loose and cause other motorists to have an injury accident. It is important that fairings be installed properly. Failure to comply may result in death, personal injury, equipment or property damage.

1. Replace battery cover.
2. Install two bolts in step strut. Torque to 24-32 lb-ft (33-43 N·m).

3. Install fairing and install four bolts. Torque to 6-7 lb-ft (8-9 N·m).
4. Install steps by installing two bolts in each step. Torque to 24-32 lb-ft (33-43 N·m).

### Slow Battery Charging

 **WARNING**

Charger cables must be connected positive to positive (+ to +) and negative to negative (- to -). If connected improperly, batteries could explode. Failure to comply may result in property damage, personal injury, or death.

 **WARNING**

Always make sure the battery charger is OFF before connecting or disconnecting the cable clamps. To reduce the danger of explosions and resulting death or personal injury, do not connect or disconnect charger cables while the charger is operating.



**NOTE**

Some vehicles may have an ultra capacitor mounted in the battery box. These devices have a similar shape to a battery but have two positive posts and one negative posts. Do not attach battery chargers to these devices to recharge the vehicles batteries. Connect directly to the conventional two post charging batteries to charge them.



**NOTE**

Follow the instructions that come with your battery charger.

1. Access the battery terminals, the batteries do not have to be removed from the vehicle.
2. Make sure the battery charger is turned off.
3. Disconnect the battery cables.
4. Connect charger cables.
5. Start charging the battery at a rate not over 6 amperes. Normally, a battery should be charged at no

more than 10 percent of its rated capacity.

6. After charging, turn OFF charger and disconnect charger cables.

**Alternator**

Take the following precautions to avoid burning out alternator diodes:

- DO NOT start the engine with alternator disconnected (connections removed) from the circuit.
- Before welding, disconnect all electronic connections to the vehicle batteries.
- Remove battery power cable and insulate it from the vehicle.
- DO NOT run the engine with the batteries disconnected.
- DO NOT disconnect the battery cables or alternator connection cables with the engine running
- Never turn the ignition switch from the ON position to the START position with the engine running.
- When charging the battery (installed in the vehicle) disconnect the battery cables.

- DO NOT reverse the cables of the alternator, starter motor, or battery.
- DO NOT polarize the alternator. The alternator should not be polarized like a generator. To ensure correct polarity, use a test lamp or a voltmeter.

**Remote Keyless Entry**

The system will lock or unlock cab doors with the key fob. The system will alert you with parking lights when the selected doors are locked or unlocked. There are two key fobs provided with the system which provide secure rolling code technology that prevents someone from recording the entry signal.

If you have issues with a key fob, replace the battery and reprogram the key fob. In some situations, the key fob may need to be replaced and in others, a fuse may have failed that could render both key fobs inoperative. Contact your dealer for help if a key fob does not work and it is not because of a bad battery.

The key fob uses one CR2032, 3V battery. Batteries should last approximately three years, depending on use. Consistently reduced range is an indicator that the battery needs replacement. Batteries are

available at most discount, hardware, and drug stores. The battery can be accessed by removing the cover of the key fob. After a new battery is installed, the key fob may need to be reprogrammed to pair with the vehicle.

Quantity	Type
1	CR2032

### How to replace key fob battery

If the key fob will not unlock the doors, replace the battery.

1. Remove the cover of the key fob.
2. Replace the battery and dispose of the old battery.
3. Check to see if the key fob is still paired to the vehicle. If not, reprogram the key fob.

### Programming Key Fobs

The key fob may need to be paired with the truck when the battery is replaced or when the key fob has not been used for an extended period of time.

1. Turn the ignition switch to the ON position.
2. Open the driver and passenger doors.
3. Press and hold the passenger door's unlock button for 5 seconds, then release the button.
4. Within 3 seconds press and hold the passenger door's lock button for 5 seconds, then release the button. At this time you should hear the vehicle cycle the locking system by unlocking, then relocking the doors. (This indicates that the door module has entered "learning mode.")
5. Within the next 10 seconds, press and hold the key fob's lock button for 5 seconds, (you should hear the vehicle lock the doors) then press and release the unlock button.
6. Once programming is complete (or the 10 seconds from Step 5 has passed), the vehicle will cycle the locking system twice (unlock, lock, unlock, lock). This process should be repeated for each fob to be paired with the module. A maximum of five key fobs may be paired to a single module.

## Engine Maintenance

These topics relate to the operator maintenance tasks for the engine. Information provided here is in addition to information contained in the Engine Operator Manual supplied with the vehicle.



### WARNING

Exhaust fumes from the engine contain carbon monoxide, a colorless and odorless gas. DO NOT breathe the engine exhaust gas. A poorly maintained, damaged, or corroded exhaust system can allow carbon monoxide to enter the cab. Entry of carbon monoxide into the cab is also possible from other vehicles nearby. Failure to properly maintain your vehicle could cause carbon monoxide to enter the cab, resulting in personal injury or death.



**WARNING**

NEVER start or let the engine run in an enclosed, unventilated area. Exhaust fumes from the engine contain carbon monoxide, a colorless and odorless gas. Carbon monoxide can be fatal if inhaled. Failure to comply may result in property damage, personal injury, or death.



**WARNING**

Never idle your vehicle for prolonged periods of time if you sense that exhaust fumes are entering the cab. Investigate the cause of the fumes and correct it as soon as possible. If the vehicle must be driven under these conditions, drive only with the windows open. Failure to repair the source of the exhaust fumes may result in death, personal injury, equipment or property damage.



**NOTE**

Keep the engine exhaust system and the vehicle's cab ventilation system properly maintained. It is recommended that the vehicle's exhaust system and cab be inspected (1) By a competent technician every 15,000 miles (24,140 km); (2) Whenever a change is noticed in the sound of the exhaust system; or (3) Whenever the exhaust system, underbody, or cab is damaged.

**Check Engine Oil Level**



**WARNING**

Hot engine oil can be dangerous. You could be burned. Let the engine oil cool down before changing it. Failure to comply may result in death, personal injury, equipment or property damage.

1. Park the vehicle on level ground and wait 15 minutes after shutting the engine OFF. This allows time for the oil to drain to the oil pan.
2. Remove the dipstick and wipe it off with a clean, lint-free rag.
3. Reinsert the dipstick all the way in and pull it out again to check oil level. Correct oil level is between the low (L) and high (H) marks on the dipstick.

To check the engine oil level:

### Topping Up the Engine Oil

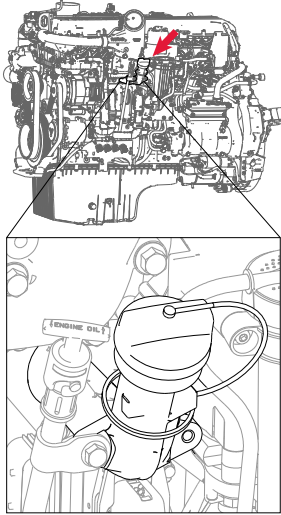

1. Top up with oil, if necessary, via the filler opening. Use the correct grade in the correct quantity. For oil replacement, please see engine Operator's Manual included with this chassis.
2. After topping up, wait 1 minute and check the oil level again.
3. Reinstall the oil fill cap and twist to lock it in place.

### Pipe and Hose Clamp Torque Values

Torque specifications for engine parts.

Application	Type of Clamp	lb-in.	N•m
Radiator and Heat Exchanger Hoses	Constant Torque CT-L	90-110	10.2-12.5
Heater Hoses	Constant Tension	not required	not required
Air Intake Pipes	Hi Torque HTM-L	100-125	11.3-14.2

Application	Type of Clamp	lb-in.	N·m
Plastic Air Intake Pipes	Constant Torque CT-L	88	10.0
Charge Air Intake Hoses	Flex Seal	70-100	7.9-11.3
	B9296	50-60	6-7
Fuel, Oil and Water Heat Exchangers (for hoses less than 9/16 in. diameter).	Miniature 3600L	10-15	1.1-1.7

5

### Install Engine Belt

You can extend the reliability and service life of your vehicle's drive belts with proper attention to installation and maintenance. Neglect could cause belt failure. The result could be the loss of the electrical or air system as well as possible engine damage from overheating.



**NOTE**

See the engine manufacturer's operator's manual for further information on replacing engine drive belts.

The images below may not appear like the configuration of the vehicle. The procedure

is still the same. Follow this procedure to install an accessory drive belt:

1. Route the new belt around the pulleys, and then rotate the automatic tensioner so that the idler pulley swings toward the belt routing. The following figure shows an example of the rotation direction to release the tensioner.

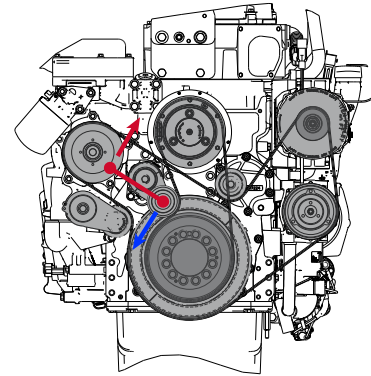

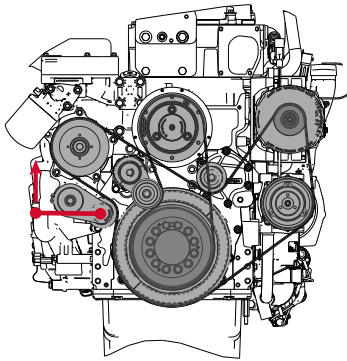

2. Slip the belt around the idler pulley attached to the automatic tensioner.
3. Release the automatic tensioner.
4. Check the belt alignment on each pulley. The belt must fall between the flanges of each pulley.

## Engine Fan



### WARNING

DO NOT work on or near the fan with the engine running. Anyone near the engine fan when it turns on could be injured. If it is set at MANUAL, the fan will turn on any time the ignition key switch is turned to the ON position. In AUTO, it could engage suddenly without warning. Before turning on the ignition or switching from AUTO to MANUAL, be sure no workers are near the fan. Failure to comply may result in death or personal injury.

Follow these guidelines to check your engine fan:

- With the engine shut off, check the fan hub bearings for looseness, loss of lubricant, and any abnormal conditions (e.g. fan belt misaligned or excessive wear/damage, etc.).
- With the engine idling and the hood open, stand at the front of the vehicle. Listen for any noises coming from the fan hub. Bearings that have lost lubricant and are dry will typically emit a squeal or a

growl when the engine is at operating temperature and the fan clutch is engaged. If noise is detected, have the fan bearings inspected by an authorized dealership.

## Engine Fan Blade

Verify that there is enough fan blade clearance with the fan shroud. The recommended distance around the fan shroud is 1 in. (25 mm) from front edge of any fan blade-to-radiator side member. Minimum clearance is 3/4 in. (19 mm).

- Rear edge of any blade must be no closer than 3/8 in. (9 mm) to the nearest engine component. If this cannot be obtained, the fan spacer or fan is incorrectly placed.
- The leading edge of any fan blade must be 1 in. (25 mm) from the inside edge of the shroud.

## Air Intake System

Engine heat, vibration, and age combine to loosen air intake connections and cause cracks in the tubing and elbows. Leaks in the intake system allow abrasive dust to enter the engine and quickly cause expensive damage. During your daily walk-

around inspection, carefully check all tubing, elbows, clamps, supports, and fasteners for condition and tightness. Check the charge-air-cooler for air leaks annually. The air leaks can be caused by cracked tubes or header. For service see your authorized dealer.



**CAUTION**

DO NOT use air intake pipes and connections as a step or to pull yourself up. This could loosen the connections and open the system to unfiltered air which could damage the engine.

**Turbocharger**



**WARNING**

DO NOT operate engine with turbocharger intake piping disconnected. A suction is created when the engine is running. This suction could draw your hand or anything else near it into the impeller fan. You could be injured. Al-

ways keep the intake piping connected when you will be running the engine.

When servicing the air intake and exhaust systems on a turbocharged engine, check the items listed below:

**Lubricating System**

Check the oil lines, housing, and connections. Look for leaks, damage, or deterioration. Leaks could mean you have damaged oil lines or oil seals.

**Manifold**

With the engine operating, check for leaking manifold or flange gaskets.

**High Frequency Vibration**

Vibration may indicate turbo rotor imbalance. Have your dealer investigate this immediately. If you detect any deficiencies, take the vehicle to an authorized dealer for servicing. Delay could lead to severe and expensive damage to your vehicle.

**Engine Air Filters**

The following service information is basic to all air cleaner makes and models.

Service the filter elements when the (option) locks in the extreme High position. Have the element serviced at an authorized Kenworth Dealer. Paper elements require care and proper handling, because they are critical to engine service life.

Service the air cleaner periodically. If the vehicle operates in areas with heavy dust, maintenance should be more frequent.

**Replace Engine Air Filter**

If the vehicle is equipped with Cab mounted air cleaner and under hood air intake option, remove the air solenoid first..

1. Park the vehicle. Set the parking brake and turn the ignition OFF.
2. If the air cleaner is under the hood, open the hood to access the air filter housing.
3. Loosen the hardware that holds the housing cap to the main filter enclosure.
4. Pull the air filter housing cap away from the main enclosure to access the filter.
5. Visually inspect the filter housing, enclosure, and hardware for damage.



6. The filter can be removed by gently pulling it directly out of the main enclosure. Be careful not to drop or tap the filter on the housing during removal as this could loosen dirt and dust trapped in the filter. DO NOT clean or reuse the original filter.
7. Inspect the sealing surfaces and clean out any debris from the inside of the filter enclosure before installing the new filter. Be careful to not push any contaminant into the engine inlet.
8. Visually inspect the new filter prior to installation. There should not be any damage to the filter media or gaskets, such as dents, dings, cracks, or holes.
9. After installing the filter, inspect for a good seal, if possible.
10. Install the filter housing cap and tighten the hardware. DO NOT use the housing cap to drive the filter into position.
11. Start the engine and allow the air system to reach operating pressure. Activate the under hood air switch and verify that there are no air leaks.

### Engine Air Filter Pre-Cleaner (Option)

Certain truck models may have an engine air filter pre-cleaner. This pre-cleaner keeps the main engine air filter from quickly filling with dust in vocational applications. The pre-cleaner should be inspected and cleaned periodically as defined in the Maintenance chapter or sooner based on your vehicle's application. Vehicles operating in extremely dusty environments may need to inspect and clean the pre-cleaner more frequently than suggested in the Maintenance chapter. The air filter restriction gauge may not be an accurate indicator of pre-cleaner condition.

### How to Remove the Pre-cleaner Filter

Tools and Components:

- 8mm torque wrench

Perform with hood open (see [How to Open the Hood](#)), standing on either side of hood.

1. Locate Pre-cleaner at underside of hood, top center.
2. Remove fender liner for better access to Pre-cleaner (see [How to Remove a Fender Liner](#) on page 196).

3. Remove upper left and lower right Pre-cleaner fasteners using wrench, and set aside.
4. Loosen, but do not remove, lower left and upper right Pre-cleaner fasteners.
5. Twist Pre-cleaner counter-clockwise to unlock, then remove.



#### NOTE

Verify hood plenum is free of debris.

If cleaning the Pre-cleaner, see [How to Clean the Pre-cleaner Filter](#). If installing a replacement, see [How to Install a Pre-cleaner Filter](#).

### How to Clean the Pre-cleaner Filter

Tools and Components:

- Gentle soap
- Warm, low-pressure water source



**CAUTION**

Do not use high-pressure water or air to clean or dry the Pre-cleaner Filter Assembly. High-pressure water or air could damage the filter media, reducing its effectiveness, and decrease the service life of both the Pre-cleaner Filter Assembly and the Primary Engine Air Cleaner. Failure to comply may result in equipment or property damage.

5

The Pre-cleaner must be removed from the vehicle prior to cleaning (see [How to Remove the Pre-cleaner Filter](#) on page 247.).

1. Shake Pre-cleaner until majority of dust and debris is removed.
2. Examine Pre-cleaner for damage to the filter media:
  - a. If the filter media is damaged, stop this procedure and install a new Pre-cleaner assembly.
3. Apply (or spray) soap on both sides of the Pre-cleaner media and allow a few minutes for the soap to sink in.

4. Flush dirt from filter using warm, low-pressure water applied to cleaner (engine side) side of filter until water runs clear.
5. Rinse Pre-cleaner using warm, low-pressure water until no soap remains.
6. Gently shake filter of excess water and allow Pre-cleaner to dry before installing.

See [How to Install the Pre-cleaner Filter](#) on page 248 for installation.

**How to Install the Pre-cleaner Filter**

Tools and Components:

- 8mm torque wrench
- New (or cleaned and dry) Pre-cleaner Filter Assembly

Steps in this procedure assume that the How to Remove the Pre-cleaner Filter procedure was performed.

1. Insert new (or cleaned and dry) Pre-cleaner into cavity, aligning both installed fasteners with larger holes on Pre-cleaner.
2. Twist Pre-cleaner clockwise to lock in filter.
3. Tighten then torque both fasteners to 7–11 lb-ft (9–15 N·m).

4. Install and tighten remaining fasteners, then torque to 7–11 lb-ft (9–15 N·m).
5. Reinstall Fender Liner ([How to Reinstall a Fender Liner](#) on page 197).
6. Close and secure hood ([Close the Hood](#) on page 16).

**Exhaust System**

The exhaust system is part of the noise and emission control system. Periodically check the exhaust system for wear, exhaust leaks, and loose or missing parts. For details on how to maintain the emissions components in the exhaust system, see "Noise and Emission Control" in your vehicle operator's manual. Please refer to the engine operator's manual for more details on how to maintain the emissions components in the exhaust system.

## Engine Mounting



### CAUTION

DO NOT re-torque or reuse existing flange head bolts. These bolts are factory set to the specified torque. If bolts are loose or damaged, they must be replaced with the new bolts. Failure to comply may result in property damage.

Periodic Inspection: Inspect engine mounts every 60,000 miles (96,000 km).

Check for the following:

- Inspect both mount and leg fasteners. Check for loose or broken bolts. Replace as necessary.
- Check mount and leg for fractures, breaks or deformation. Replace as necessary.
- Check for complete insertion of motor mount. Replace as necessary.
- New leg to mount flange head bolts should be torqued to 210-230 lb-ft (284-311 N·m).

## Fuel System

Please follow these recommendations when you are changing your fuel filters or strainer elements. Your vehicle's engine will run better and last longer if you do. See the engine manufacturer's recommendations for proper water and micron requirements.

### Draining the Primary Fuel Filter

The following tools are suggested for this procedure:

- Container (1 liter capacity) (optional)
- 3/8" diameter rubber hose (optional)

Perform with engine OFF. Cover any electrical equipment and wiring that might get soaked with fuel – diesel fuel may permanently damage electrical insulation. If draining to replace filter, drain into container with a minimum 1 liter (1 qt) capacity, and use hose to route fluid.

1. Open the hood (see [How to Open the Hood](#)), and locate the primary fuel filter.

2. Open drain valve (by hand only) until draining occurs. If draining to replace the filter, before opening valve, push one end of hose onto drain valve and route other end to the container.
3. Drain fluid from filter assembly:
  - If draining water from fuel, drain filter bowl of water until clear fuel is visible, then close drain valve, or
  - If replacing filter, drain until flow stops, then close valve.



### CAUTION

Do not overtighten the valve. Over tightening can damage the threads.

If a hose was used to drain fluid, remove hose.

If entire filter assembly was drained, proceed to Replacing the Primary Fuel Filter.

### Replacing the Primary Fuel Filter

The following tools are suggested for this procedure:

- Bowl wrench RK61680
- 1" wrench
- New PACCAR primary fuel filter element designed for this application
- 2 new O-rings

Start procedure with engine off. Cover any electrical equipment and wiring that might get soaked with fuel; diesel fuel may permanently damage electrical insulation. To expel air from density-type strainer elements, soak them in clean fuel before installing them. Lubricate new O-rings with clean fuel to ensure a positive seal.

1. Disconnect clip-type electrical connections from bowl bottom:
  - a. Disconnect water in fuel (WIF) sensor from wire bundle.
  - b. Disconnect electrical heater sensor from wire bundle.
2. Using bowl wrench, loosen filter bowl and lower at least 2 inches. Take care not to damage bowl sensors on surrounding components.
3. Slowly remove bowl and filter from upper filter assembly.
4. Remove the filter element and both upper and lower O-rings.

5. Install new filter element:
  - a. Install new upper and lower O-rings.
  - b. Install new fuel filter element.
6. Reconnect clip-type electrical connections to bowl bottom:
  - a. Reconnect water in fuel (WIF) sensor to wire bundle.
  - b. Reconnect electrical heater sensor to wire bundle.
7. If your vehicle has a fuel blending valve, turn valve to "Prime."
8. Prime fuel filter assembly:
  - If your assembly contains a manual priming pump (PX-7 engines) press priming pump repeatedly until pumping action becomes firm, or
  - Allow the electric priming pump to prime assembly (non PX-7 engines).
9. Start the vehicle. For PX-7 and PX-9 engines, idle for 5 minutes.
10. If your vehicle has a fuel blending valve, turn valve to "Run."

Observe fuel filter assembly for leaks. Dispose of old filter element and O-rings properly.

## Fuel Tank

## Frame



### WARNING

DO NOT cut, splice or weld frame rails or drill through the top or bottom flanges of the rails. These operations could affect frame rail strength leading to a failure resulting in an accident. Rail failures resulting from such modifications are not warrantable. Failure to comply may result in property damage, personal injury, or death.



**WARNING**

Frame welding is NOT recommended. The high heat of welding nullifies the special heat treatment of the rails, greatly reducing the tensile strength of the frame rail. If a frame member becomes cracked from overloading, fatigue, surface damage, or a collision, the only permanent repair is to replace the damaged frame member with a new part.

**Emergency Welding**

In an emergency, a temporary repair may be performed. Observe the following precautions to protect electronic systems during welding operations. Emergency welding procedures are further explained in the maintenance manuals. Please refer to the ordering information on the back cover to obtain a maintenance manual. In the event of emergency welding of a frame rail and when welding any other part of your truck or any component attached to your truck, observe the following precautions before welding:

- Disconnect all electronic devices. It is not possible to list all of the

electronics that could be affected, but a few examples include the following: alternator, engine Electronic Control Unit (ECU), transmission ECU, ABS ECU, navigation devices, diagnostic devices, and monitoring devices.

- Disconnect battery cables and insulate them from the vehicle.
- Do not use the ECU or engine ground stud for the ground of the welding probe.
- Ensure that the ground connection for the welder is as close to the weld point as possible. This ensures maximum weld current and minimum risk to damage of electrical components on the vehicle.

**Painting**

Do not electrostatically paint your truck or any component on your truck without first removing all of the electronic components from the truck. It is not possible to list all of the electronics that could be affected, but a few examples include the alternator, engine Electronic Control Unit (ECU), transmission ECU, ABS ECU, navigation

devices, diagnostic devices, and monitoring devices.

**Fifth Wheel Monthly Maintenance**

- Refer to specific manufacturer's literature for any special instructions
- Steam clean the fifth wheel
- Check lock guard operation using a commercial lock tester
- Clean and oil all moving parts
- Lubricate the lock mechanism with a lithium-base grease
- All grease fittings (especially those which grease the top surface of the fifth wheel)

**Fifth Wheel Bi-Annual Maintenance**



**NOTE**

Whenever possible, torque all frame fasteners on the nut end, not the bolt head.

- Refer to specific manufacturer's literature for any special instructions.

- Remove fifth wheel from vehicle. Refer to the Shop Manual, "Fifth Wheel Removal."
- Steam clean the fifth wheel and mounting brackets.
- Check all moving parts for excessive wear or damage. Replace all worn or broken parts.
- Complete two-month service procedure.
- Install fifth wheel. Refer to the Shop Manual, "Fifth Wheel Installation."

Tighten all frame fasteners with a torque wrench. See [Frame Fastener Torque Requirements](#) on page 280.

### Sliding Fifth Wheels

Lubricate bearing surface of support bracket through the grease fittings on the side of the fifth wheel plate. Use a water resistant lithium-base grease.

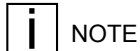

The plate must be lifted up slightly to relieve the weight of the bracket while applying grease.

## Front Axle and Suspension

### Axle Lubrication

Refer to the axle manufacturer's operator's manual for lubrication specifications and service intervals.

### Kingpin Lubrication

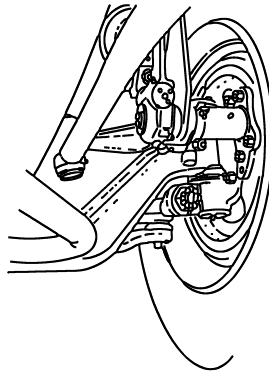

Lubricate with approved lubricant.  
Lubricate knuckle thrust bearings, knuckle

pins, and tie rod ends. Lack of lubrication causes premature wear and hard steering. Lubrication schedule may be shortened if necessary.

### Suspension Lubrication

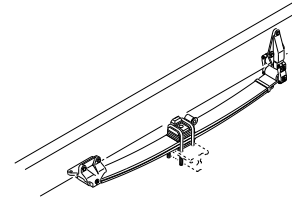

Each standard spring anchor pin has a grease fitting. Pressure lubricate spring pins as specified. At regular intervals, the spring leaves may be lubricated with a rust-inhibiting oil applied with a spray gun or brush. Depending on your suspension, lubricate all spring pins until grease flows out of both ends of the bushing. Look for signs of rust or water in the flushed grease. If a pin will not accept grease, it should be removed, cleaned, and inspected.

**CAUTION**

DO NOT spray the suspension with chemical products or mineral oil; it can cause damage to the bushings.

**Inspection**

For all vehicles, mandatory maintenance procedures include retightening all U-bolts and inspecting the suspension for loose, damaged, or abnormally worn fasteners. Visually inspect the shock absorbers, the rubber bushings, the leaf springs, and that the suspension is aligned and functioning properly. Mono leaf spring suspensions should also have their rear shackle brackets checked for proper alignment. Even with proper maintenance, however, the service life of leaf springs are affected by many factors: fatigue, vehicle gross weight, type of load, road conditions, and vehicle speed. Check for cracks, wear marks, splits, or other defects on the surface of the spring. Defective parts must be replaced. Because repaired springs cannot be fully restored to their original service life, replace the complete assembly if cracks or other defects are detected.

**Wheel Alignment**

For driving safety and comfort, and to prolong the life of your vehicle, it is important to have wheels correctly aligned. Check tire wear frequently. Uneven tire wear is a sign that the wheels may be misaligned. If you see uneven wear, take your vehicle to an authorized dealer familiar with aligning wheels on your vehicle.

**Suspension U-Bolts**

It is important that U-bolts remain tight. Severe use of your vehicle will cause them to loosen faster, and all vehicles need to have their U-bolts checked and tightened regularly. Be sure someone with the proper training and the right tools checks and tightens the U-bolts on your vehicle. New springs can settle in after service, relieving the tension on the U-bolts. Loose U-bolts can cause leaf spring breakage, axle misalignment, hard steering, and abnormal tire wear. All vehicles should have suspension U-bolts tightened after the first 500 miles (800 km) of operation. Re-torque the front spring pinch bolts and shackle pinch bolts.

**WARNING**

DO NOT operate the vehicle if the suspension U-bolts are not properly tightened. Loose U-bolts will cause the axle to not be properly secured to the suspension, which could cause loss of vehicle control and an accident. Loose U-bolts can also cause uneven tire wear and poor alignment. Failure to comply may result in death, personal injury, equipment or property damage.

U-bolts are difficult to tighten unless you have the right equipment. If you cannot tighten them correctly yourself, be sure to have them checked and tightened regularly by an authorized mechanic. Tighten U-bolt nuts to the specified torque value with the vehicle loaded to its normal gross weight. See [Suspension U-Bolts, Grade 8](#) on page 282 specifications for torque values applying to U-bolts and nuts.



**WARNING**

DO NOT replace U-bolts and nuts with common U-bolts or standard nuts. These parts are critical to vehicle safety. If the wrong U-bolts or nuts are used, the axle could loosen or separate from the vehicle and cause a serious accident. Use only U-bolts and nuts of SAE Grade 8 specification or better. Failure to comply may result in death, personal injury, equipment or property damage.

- A more frequent lubrication cycle is required for axles used in on/off-highway, refuse, or other severe service applications. Use heavy-duty, multipurpose lithium base (#2 grade) grease.



**NOTE**

DO NOT mix with sodium-based grease.



**NOTE**

If it is difficult to grease either the upper or lower bearing, try greasing the bearings with the vehicle jacked up and supported on axle stands to improve grease flow and flush contamination.

**Oil Bath**

Lubricate wheel end assembly with a drive axle lubricant that meets MIL-L-2105D specifications. Either SAE 80W-90 mineral based or 75W-90 synthetic gear oil is acceptable. Check the lubricant level at each greasing interval. Maintain the lubrication fluid level at centerline of axle or fill line on hub cap. Always check fluid level on flat ground.



**CAUTION**

Never mix oil bath and grease-packed wheel ends. Mixing oil and grease will reduce the effectiveness of both lubricants and may cause damage to the wheel ends.

5

**PACCAR 20k Front Axle Lubrication**

Proper lubrication practices are important in maximizing the service life of the steer axle assembly.

**Kingpins, Thrust Bearings, and Tie Rod Ends**

**On-Highway Applications - Standard**

- Pressure lubricate every 6 months or 25,000 miles (40,000 km).

PACCAR 20k Front Axle Lube Points

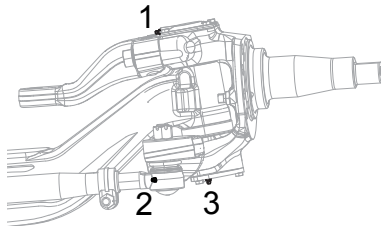

1. Upper kingpin bearing
2. Tie rod end
3. Lower kingpin bearing



## Heater and Air Conditioner Maintenance

The combination heater-air conditioner provides comfort for those in the cab through accurate control of the cab environment in all weather conditions. Regular attention to the items below will help you keep the heater-air conditioner unit running well. Keep the vehicle's ventilation system, engine exhaust system, and cab joints properly maintained. It is recommended that the vehicle's exhaust system and cab be serviced by a competent technician as follows:

- Inspected every 15,000 miles
- Whenever a change is noticed in the sound of the exhaust system
- Whenever the exhaust system, vehicle underbody, or cab is damaged

To allow for proper operation of the vehicle ventilation system, proceed as follows:

- Keep the inlet grille at the base of the windshield clear of snow, ice, leaves, and other obstructions at all times.

- Keep the exhaust pipe area clear to help reduce the buildup of exhaust gas under the vehicle.
- Check the drain tube of the fresh air inlet for trapped water before assuming that there is a leak in the heating system.

### Special Precautions



#### WARNING

Excessive heat may cause the pressurized components of the air conditioning system to explode. Never weld, solder, steam clean, or use a blow torch near any part of the air conditioning system. Failure to comply may result in death, personal injury, equipment or property damage.



#### WARNING

Air conditioning refrigerant can be hazardous to your health. DO NOT expose yourself to leaking refrigerant for prolonged periods near excessive heat, open flames, or without proper

ventilation. Failure to do so may result in death or personal injury.

If a refrigerant leak develops in the presence of excessive heat or an open flame, hazardous gases may be generated. If you become aware of a refrigerant leak on your vehicle have your system serviced immediately and observe the following precautions: Stay away from the hot engine until the exhaust manifold has cooled. Do not permit any open flame in the area. Even a match or a cigarette lighter may generate a hazardous quantity of poisonous gas. Do not smoke in the area. Inhaling gaseous refrigerant through a cigarette may cause violent illness.

### Heater



#### CAUTION

During extreme cold weather, DO NOT blow hot defroster air onto cold windshields. This could crack the glass. Turn the Air Flow Control Dial to Defrost and adjust the fan speed accordingly while the engine warms. If the engine is already warm, move the Temperature Control Dial to "cool," then gradually increase the temperature when you see that the windshield is starting to warm up. Failure to comply may result in equipment damage.

- Check all heater controls for full-range operation.
- Check hoses, connections, and heater core for condition and leaks.

### Air Conditioner



#### WARNING

The air conditioning system is under pressure. If not handled properly during servicing, it could explode. Any servicing that requires depressurizing

and recharging the air conditioning system must be conducted by a qualified technician with the right facilities to do the job. Failure to comply may result in death, personal injury, equipment or property damage.



#### WARNING

Wear eye protection any time you blow compressed air. Small particles blown by compressed air could injure your eyes.

- Listen to the compressor and drive clutch for noise and vibration. If you find problems, have the system checked thoroughly. A malfunctioning clutch usually indicates trouble elsewhere in the system.
- Check the evaporator core, filter, and condenser core for debris restricting air flow. Clean if necessary. Small particles may be removed with compressed air blown through the core in the opposite direction of normal air flow.

- Check the engine belt for condition and proper tension.
- Check all hoses for kinks, deterioration, chafing, and leaks. Adjust kinked or chafing hoses to eliminate restrictions and prevent further wear.
- Check all components and connections for refrigerant leaks. If you discover a leak, do not try to tighten a connection. Tightening a connection may cause a leak to worsen. Have a qualified technician correct the problem.



#### NOTE

A leaking evaporator or condenser core cannot be repaired; it must be replaced.

Have the air conditioning system fully serviced annually by your authorized dealer. Qualified service technicians will have to evacuate and recharge the system.

### Cabin Fresh Air Filter

The cab air conditioning filter is located inside the cab behind the passenger side kick panel (located below the glovebox).

After removing the required panels, the filter can be pulled from the blower unit without using any tools.

To remove the HVAC access panel: pull panel out from the bottom to release the clips, then pivot the panel outward so the tabs at the top allow the panel to drop down.

HVAC Access Panel

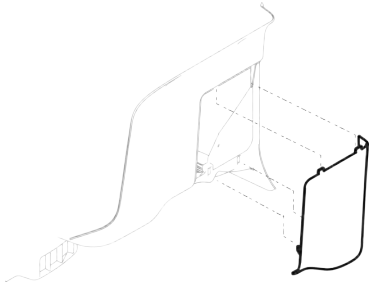

Inspect and clean cab air filter element every 3 - 6 months of service. Depending on the operating environment, if air flow from the air conditioner and heater is less efficient or windows fog easier, you may need to replace the cab air filter.

### Replace the Recirculation Air Filter

Please contact an authorized dealer when the service interval is required to inspect the cabin recirculation air filter.

## Noise and Emission Control

There are specific components on the vehicle that are designed to meet certain Environmental Protection Agency (EPA) emissions and noise regulations. To maintain conformance with the regulations, these components need to be functional and properly maintained.

### Noise Emission Warranty

Peterbilt warrants to the first person who purchases this vehicle for purposes other than resale and to each subsequent purchaser that this vehicle as manufactured by Peterbilt, was designed, built, and equipped to conform at the time it left Peterbilt's control with all applicable U.S. EPA Noise Control Regulations. This warranty covers this vehicle as designed, built, and equipped by Peterbilt, and is not limited to any particular part, component, or system of the vehicle

manufactured by Peterbilt. Defects in design, assembly, or in any part, component, or system of the vehicle as manufactured by Peterbilt, which, at the time it left Peterbilt's control, caused noise emissions to exceed Federal standards, are covered by this warranty for the life of the vehicle.

### Tampering with Noise Control System

Federal law prohibits the following acts or the causing thereof:

1. The removal or rendering inoperative by any person other than for purposes of maintenance, repair, or replacement, of any device or element of design incorporated into any new vehicle for the purpose of noise control prior to its sale or delivery to the ultimate purchaser or while it is in use, or
2. The use of the vehicle after such device or element of design has been removed or rendered inoperative by any person. Among those acts presumed to constitute tampering are the acts listed below:

**Air Intake System** Removing or rendering inoperative the air filter housing/silencers or intake piping

**Engine Cooling System** Removing or rendering the fan clutch inoperative  
Removing the fan shroud

**Engine** Removing or rendering engine speed governor inoperative so as to allow engine speed to exceed manufacturer's specifications  
Modifying ECU parameters

**Exhaust System** Removing or rendering inoperative exhaust system components

**Fuel System** Removing or rendering engine speed governor inoperative, allowing engine speed to exceed manufacturer's specifications  
Removing of air signal attenuator on engines equipped with this device  
Removing of diesel exhaust fluid tank and system

**Inner Fender Shields and Cab Skirts** Removing shield or skirts  
Cutting away parts of shields, skirts or damaged or loose portions of shields or skirts

**Noise Insulating Blankets** Removing noise insulators from engine block or from around the oil pan

Cutting holes in, or cutting away part of noise insulators

Removing hood-mounted noise insulation

### Inspecting Noise and Emission Components

The following instructions are based on inspection of the noise control system at regular intervals as indicated in the [Noise Control System - Maintenance Log](#) on page 281.

#### Air Intake System

- Do all checks and maintenance procedures listed in this manual under engine air intake system and air filter housing.
- Check the induction tubing, elbow connections, clamps, brackets, and fasteners for deterioration, cracks, and security.
- If you find an air leak anywhere between the air filter housing and the engine, repair that leak immediately.



### CAUTION

Air leaks cause excessive noise and may result in serious damage to the engine. If you do not repair them the engine damage will not be covered by your warranty. Repair all air leaks as soon as you find them.

#### Engine Mounted Noise Insulators

- Check condition. Is the insulator secure? How you do this will depend on the method of attaching the noise insulators on the engine and around the oil pan (bolts, snap fasteners, or straps). Tighten loose fasteners and repair or replace any worn or damaged fasteners.
- Check insulators around fasteners and stress points, especially where they may be affected by engine vibration. Repair any cracked or damaged mounting points. Use suitable reinforcing plates to ensure that the insulators will remain in position.

#### Exhaust System

- Check for exhaust leaks, which would indicate a leaking manifold

gasket; replace gasket if necessary.

- Check cap screws for tightness, including those at the flanges. Refer to the engine manufacturer's service manual for proper tightening sequence and torque values.

#### Joints and Clamps

- Check for leaks, and tighten as necessary. Check for deterioration or dents in pipes and clamps which could allow exhaust to escape.
- Replace any serviceable joints, flexible pipes and gaskets at the service intervals.

#### Selective Catalysts Reduction (SCR)

- Check SCR canister filter, clamps and mounting brackets. Tighten if necessary. Inspect SCR canister for signs of rust or corrosion.

#### Exhaust Piping

- Check exhaust piping for rust, corrosion, or damage. Replace deteriorated piping before holes appear. If piping is perforated at any point, temporary patching or lagging is acceptable until you can have permanent repairs made. On turbocharged engines, check joints

at flanges and mounting brackets for tightness.

#### Diesel Particulate Filter (DPF)

- Check DPF, clamps, and mounting brackets. Tighten if necessary. Inspect DPF for signs of rust or corrosion.
- Check internal baffling. You can do this by listening for rattling sounds while tapping on the (DPF with a rubber mallet or revving the engine up and down through its normal operating range.

#### Mufflers

- Check muffler, clamps, and mounting brackets. Tighten if necessary. Inspect muffler for signs of rust or corrosion.
- Check internal baffling. You can do this by listening for rattling sounds while tapping the muffler with a rubber mallet or revving the engine up and down through its normal operating range.

#### DEF Tank (See Engine Aftertreatment System manual)

#### Exhaust Tail Pipe

- Check the mounting. Tighten as necessary. The miter cut at the tip of the pipe must be facing the rear

of the vehicle. Do not modify the end of the pipe in any way.

#### Engine Fan and Shroud



#### WARNING

Do not work on the fan with the engine running. The engine fan can engage at any time without warning. Anyone near the fan when it turns on could be injured. Before turning on the ignition, be sure that no one is near the fan.

- Check all fasteners for tightness. Check for stress cracks in the shroud. Make sure the shroud is adjusted so that it does not touch the fan blades.
  - Check to verify that the fan is disengaged (not turning) with the engine running at normal operating temperatures (from cold to the point that the fan engages).
  - Check fan blade mounting bolts. Inspect fan blades to be sure they are not cracked or bent.
- #### Transmission and Driveline
- Substituting a different main transmission or driveline components, other than design-

specified units, may result in increased vehicle noise emission.

Hood Insulation Blanket

- Check all fasteners for condition and security. Repair or replace any broken or defective fasteners.

Blanket

- Check for chafing or tears. Patch it if necessary. Find the cause of the damage. If any component or accessory is causing wear or damage and cannot be relocated, put reinforcing pads on the blanket at the site of wear.

Inner Fenders Shields and Cab Skirts

- Check all fasteners, especially the self-tapping hex head screws. Are they secure? Remove and replace any loose rivets.

Shields and Skirts

- Check shields and skirts for cracks at mounting and stress points. Check fender shields for tire marks, worn spots, or damage from objects thrown from tire treads. You can repair cracked or damaged fiberglass fender shields with fiberglass and resin.
- If you find damage at a fastening point, you can gain additional

strength by installing a suitable reinforcing plate. This plate should be drilled to accept a rivet and laminated to the shield with fiberglass and resin.

- Check cab skirts, sills, and brackets for overall condition and repair them as necessary. Damaged rubber fender shields or cab skirting cannot be repaired. You will need to replace it.



NOTE

Your authorized dealer can perform all of these checks and repairs or replacements.

## Rear Axle and Suspension

Your vehicle's suspension, by design, requires a minimal amount of maintenance. However, suspensions in over-the-road operations require periodic inspection to ensure trouble-free performance.



**WARNING**

DO NOT work on the vehicle without the parking brake set and wheels blocked securely. If the vehicle is not secured to prevent uncontrolled vehicle movement, it could roll and may result in death, personal injury, equipment or property damage.

## Diesel Exhaust Fluid Tank

Vehicles that comply with 2010 EPA emission requirements will have a Diesel Exhaust Fluid (DEF) tank mounted to the vehicle frame.



**WARNING**

DO NOT operate the vehicle if the suspension U-bolts are not properly tightened. Loose U-bolts will cause the axle to not be properly secured to the suspension, which could cause loss of vehicle control and an accident. Loose U-bolts can also cause uneven tire wear and poor alignment. Failure to comply may result in death, personal injury, equipment or property damage.



**WARNING**

Failure to maintain the specified torque values or to replace worn parts can cause component system failure, possibly resulting in an accident. Improperly tightened (loose) suspension U-bolts can lead to unsafe vehicle conditions, including: hard steering, axle misalignment, spring breakage or abnormal tire wear. Failure to comply may result in death, personal injury, equipment or property damage.



**CAUTION**

DO NOT spray the suspension with chemical products or mineral oil; it can cause damage to the bushings.



**NOTE**

Failure to follow these recommendations could void warranty.

**Visual Inspection**

For all vehicles, mandatory maintenance procedures include retightening of U-bolts and complete inspection. Even with proper maintenance, however, many factors affect the service life of springs and suspension components: fatigue, vehicle gross weight, type of load, road conditions, and vehicle speed. All vehicles need to have their U-bolts checked and tightened regularly, but severe use of your vehicle can cause them to loosen faster. It is important that U-bolts remain tight. Be sure someone with proper training and the right tools checks and tightens the U-bolts on your vehicle. After the first 500 miles (800 km) of operation,

periodically inspect the suspension as noted below:

- Visually check for loose or missing fasteners, cracks in hanger, or axle connection brackets
- Check that springs are centered in hangers and in good condition
- Check for cracks, wear marks, splits, or other defects on the surface of the spring
- Replace defective parts. Because repaired springs cannot be fully restored to their original service life, replace the complete assembly if cracks or other defects are detected
- After replacement of any part or discovery of loose components, check the torque of all fasteners
- New springs settle-in after the vehicle's initial service, causing the U-bolts to become loose

**Rear Suspension Fasteners**

To maintain the performance of the air suspension, check fastener torque values after the first 2,000 miles (3,200 km) of service and every 60,000 miles (96,000 km) thereafter. Torque recommendations apply to fasteners supplied and installed by

vehicle manufacture. The values listed at the back of this chapter (See *Suspension U-Bolts, Grade 8* on page 282 and *Frame Fastener Torque Requirements* on page 280), are for cadmium plated or phosphate and oil fasteners only.

### Rear Suspension U-Bolts

U-bolts are difficult to tighten unless you have the right equipment. If you cannot tighten them correctly yourself, be sure to have them checked and tightened regularly by an authorized mechanic.

#### NOTE

To ensure an accurate torque reading, use properly maintained and calibrated torque wrenches. Clean the nut and bolt. No dirt, grit, or rust should be present.

#### WARNING

DO NOT operate the vehicle if the suspension U-bolts are not properly tightened. Loose U-bolts will cause the axle to not be properly secured to the suspension, which could cause loss of

vehicle control and an accident. Loose U-bolts can also cause uneven tire wear and poor alignment. Failure to comply may result in death, personal injury, equipment or property damage.

#### NOTE

Whenever possible, torque all frame fasteners on the nut end, not the bolt head.

Load the vehicle to its normal gross weight before tightening U-bolts. Loading the vehicle ensures proper adjustment of the U-bolt and spring assembly.

#### WARNING

DO NOT replace U-bolts and nuts with common U-bolts or standard nuts. These parts are critical to vehicle safety. If the wrong U-bolts or nuts are used, the axle could loosen or separate from the vehicle and cause a serious accident. Use only U-bolts and nuts of SAE Grade 8 specification or better. Failure to comply may result in

death, personal injury, equipment or property damage.

### Rear Axle Lubrication

Check oil level with the vehicle parked on level ground and the fluid warm. The level should be even with the bottom of the filler hole.

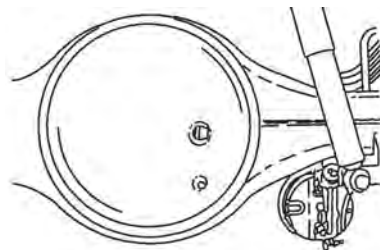





**CAUTION**

DO NOT mix lubricants of different grades; although, mixing different brands of the same grade lubricant (meeting MIL-L-2105C), is acceptable. Lubricants of different grades are not compatible and could damage the axle.



**NOTE**

In all cases, lubricant supplier assumes full responsibility for the performance of their product, and for product and patent liability.

For recommended types and brands of lubricants, contact your dealer.

**Dana Spicer and Fabco**

No initial drain is required on Dana Spicer axles that are factory filled with an Dana Spicer-approved synthetic lubricant.

- Petroleum-based lubricants must be drained within the first 5,000 miles (8,000 km) if converting to an approved synthetic lubricant.

Initial Change: See *Preventive Maintenance Intervals* on page 173 for standard rear axle service intervals.

Change mineral-based lubricant in other Dana Spicer and Fabco axle assemblies (new or rebuilt) within the first 3,000 to 5,000 miles (4,800 to 8,000 km).

- For petroleum-based axles, use lubricants meeting MIL L2105C/D grade specifications or approved synthetic lubrication. Do not use oil additives.

All Vehicles with Dana Spicer and Fabco Axles: See *Preventive Maintenance Intervals* on page 173. Contact your dealer for approved synthetic lubricant brands.

- Dana Spicer Axles with synthetic lubrication and Out Runner Seals: drain, flush, and refill at 500,000 miles (804,000 km).

Axle Housing Breather Vent:

- Check and clean the axle housing breather vent at each oil level check.

Meritor:

- See *Meritor Lubrication Maintenance Manual (MM1)*.

**Drive Axle - Dana**

Drain the lubricant while warm. Flush each unit with clean flushing oil. Change the lubricant.

**Drive Axle - Meritor**

Drain and replace the lubricant.

**Rear Axle Alignment**

Continual road shock and load stresses may force the rear axles out of alignment. If you detect rapid tire wear on the rear axles, you may have misaligned axles. If you suspect rapid tire wear, have your rear axle alignment checked and adjusted by an authorized dealer.

Suspension alignment should be checked when any one of the following conditions exist:

- Total vehicle alignment required after a body has been installed on truck chassis.
- Discovery of loose suspension fasteners (Loose, defined as any torque below the recommended torque value)
- Discovery of elongated holes in a suspension component

- Bushing replacement
- Excessive or abnormal tire wear
- Immediately after post body installation (See First Day in the Maintenance Chapter)

## Steering System



### WARNING

DO NOT operate the vehicle if the steering system is not working properly. You could lose control of your vehicle if the steering system is not in good working condition, which could result in a serious accident. For driving safety, visually check the steering gear and components. Frequent checks are important for driving safety, especially after traveling over rough roads. Failure to comply may result in personal injury, property damage, or death.



### WARNING

If this chassis is equipped with an electronic stability system (ESC) and any part of the steering system (e.g., linkage, steering driveline, column, front end alignment, etc) is repaired, removed, or disassembled in any way, or if the steering angle sensor is replaced, the steering angle sensor must be recalibrated. Any repairs or adjustments to any part of the steering system must be performed by an authorized dealer. Failure to comply may result in personal injury, property damage, or death.

Hydraulic fluid (under low pressure) provides the power to operate the steering gear. It also serves to lubricate moving parts and remove heat. A loss of steering efficiency will occur if too much heat builds up in the system.

If the steering feels unbalanced from side-to-side while turning, check for the following possible causes:

- Unequal tire pressures
- Vehicle overloaded or unevenly distributed load

- Wheels out of alignment
- Wheel bearings improperly adjusted

If you cannot correct the problem, check with an authorized dealer.

Your vehicle is equipped with integral power steering. The system includes an engine-driven fluid pump, a fluid reservoir, the steering gear, and connecting hoses. Because of the hydraulic power assist, little effort is required to turn the steering wheel. When no input is applied through the steering wheel, the steering gear will return to the neutral position. If, for any reason, the power assist system goes out, steering the vehicle is still possible but it will require much greater effort.

Visually check the following parts:

- Crosstube: Is it straight?
- Drag link tube clamp: Check for looseness or interference
- Ball joints and steering U-joints: Check for looseness
- Steering wheel for excessive free-play. Check the simplest probable causes first: (A) unequal tire pressures; (B) loose cap nuts; (C) bent crosstube; or (D) lack of lubrication

If these checks do not reveal the problem, or if you correct them and still have a steering problem, take your vehicle to an authorized dealer for evaluation.

### Power Steering Fluid

 <b>CAUTION</b>
When adding fluid, be sure to use fluid of the same type. While many fluids have the same description and intended purpose, they should not be mixed due to incompatible additives. Mixing incompatible fluids may lead to equipment damage.

 <b>NOTE</b>
Before removing reservoir cap, wipe the outside of the cap so that no dirt or debris falls into the reservoir.

Check the power steering fluid level using the following procedure:

1. Park the vehicle on level ground and turn the engine off.
2. Open hood

3. Open the fill cap to the power steering reservoir.
  - If you check the fluid with the engine and steering system COLD, the fluid level should be at or above the Minimum indicator level and should generally not exceed the middle point between Maximum and Minimum level indicators.
  - If you check the fluid with the engine and steering system WARM, the fluid should NOT exceed the Maximum level indicator and should generally not drop below the middle point between the Maximum and Minimum level indicators.

### Steering Shaft Bolt Torque Specifications

The steering (intermediate shaft) U-joint pinch bolt should be tightened on the first day or two of operation, then checked weekly (see Weekly Checks). The following are common torque specifications for most steering shafts.

### Steering U-joint Pinch Bolt

Fastener Size	Torque Spec. lb-ft (N•m)
7/16 -in.	37-43 (50-58)

### Pitman Arm Clamp Bolt

Fastener Size	Torque Spec. lb-ft (N•m)
3/4 -in.	300-320 (406-433)



**WARNING**

If this chassis is equipped with an Electronic Stability Control (ESC) and is modified (e.g. adding or removing an axle, converting from a truck to a tractor, converting from a tractor to a truck, changing the body, lengthening of the wheelbase and/or frame, relocating frame components, or modifying pneumatic or electrical ABS/ESC harnesses) the ESC must be evaluated by a qualified technician. If you have any questions, contact your authorized dealer. Failure to comply may result in property damage, personal injury, or death.



**WARNING**

Improper lubrication of U-joints can cause them to fail prematurely. The driveshaft could separate from the vehicle and result in an accident. Make sure lubricant is purged at all four ends of each U-joint and loosen caps if necessary. Also, regularly inspect U-joints for excessive wear or movement, and repair or replace as necessary. Failure to comply may result in death, personal injury, equipment or property damage.

operation. Here are some tips on maintaining your tires.

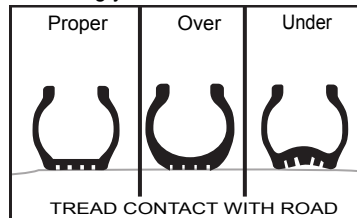

**WARNING**

DO NOT repair damaged tires unless you are fully qualified and equipped to do so. Wheel and tire assemblies cannot be worked on without proper tools and equipment, such as: safety cages or restraining devices. Have all tire repairs performed by an expert. Stand away from the tire assembly while the expert is working. Failure to do this may result in death or injury.

5

**Driveline**

See the driveshaft manufacturer's operator's manual for lubrication specifications and service intervals.

**Tires**

Your tires are a very important part of your vehicle's whole braking system. How fast you can stop depends mostly on how much friction you get between the road and your tires. In addition, keeping your tires in good condition is essential to the safe, efficient operation of your vehicle. Regular, frequent inspection and the right care will give you the assurance of safe and reliable tire

**Checking Inflation Pressure**

Low pressure is a tire's worst enemy. Underinflation allows tires to flex improperly, causing high temperatures to build up. Heat causes early tire damage

such as flex break, radial cracks, and ply separation. Low pressure may affect control of your vehicle, especially at the front wheels. Most tire wear problems are caused by underinflation as the result of slow leaks, so check tire pressure regularly. Lower tire pressure does not provide better traction on ice or snow. Give your tires a visual test every day, and check inflation with a gauge every week:

- When checking tire pressure, inspect each tire for damage to sidewalls, cuts, cracks, uneven wear, rocks between duals, etc. If a tire appears underinflated, check for damage to the wheel assembly. Don't forget to check between dual wheels. If you find wheel damage, have an expert tire service repair it.
- Maximum tire pressure will be indicated on the sidewall of a tire.
- Check pressure only when the tires are cool. Warm or hot tires cause pressure buildup and will give you an inaccurate reading. So never deflate a warm tire to the specified pressure.



**WARNING**

DO NOT operate a vehicle with under-inflated tires. The extra heat caused by underinflation can cause sudden tire failure such as a tire fire or blow out, which can cause an accident resulting in death or personal injury. Low pressure may affect control at the front wheels, which could result in an accident involving death or personal injury. Keep your tires inflated to the manufacturer's recommended air pressure.



**WARNING**

DO NOT attempt to raise the vehicle to remove or install a damaged tire and wheel assembly if you are not fully qualified and not equipped with the proper tools and equipment. DO NOT attempt to reinflate a tire that has been run flat. Obtain expert help. A person can be seriously injured or killed if using the wrong service methods. Truck tires and wheels should be serviced only by trained personnel using proper

equipment. Follow OSHA regulations per section 1910.177.



**NOTE**

Follow all warnings and cautions contained within the tire and wheel manufacturers literature.

**Overloaded Tires**

Overloading your truck is as damaging to your tires as underinflation. The following chart shows how neglect or deliberate abuse can affect the life of your tires.

**Effects of Load and Pressure on Tire Life**

Vehicle Load	Tire Pressure	Expected Total Tire Mileage
Normal	Normal	Normal
20% Over	20% Low	70%
40% Over	30% Low	50%

Vehicle Load	Tire Pressure	Expected Total Tire Mileage
60% Over	35% Low	40%
80% Over	45% Low	30%
100% Over	55% Low	25%

### Overinflated Tires

Overinflating the tires reduces the tread contact area with the road surface, concentrating all of the vehicle weight on the center of the tread. This causes premature wear of the tire.



#### WARNING

Overinflated tires can cause accidents. They wear more quickly than properly inflated tires and are more subject to punctures, cracks, and other damage. They could fail and cause you to lose control of your vehicle resulting in an accident causing death or personal injury. Be sure all tires are inflated cor-

rectly according to the manufacturer's recommendations.

### Matching Tires

Be sure to buy matched tires for your vehicle, especially on the rear axles. Mismatched tires can cause stress between axles and cause the temperature of your axle lubricant to get too hot. Matched tires will help your driveline last longer and will give you better tire mileage.



#### WARNING

DO NOT mismatch tires, it can be dangerous. Never mix tires of different design such as steel belted radials and bias ply tires, etc. Mixing tire types and sizes will adversely affect the road holding ability of both types of tires and can lead to loss of vehicle control and causing death or personal injury.



#### WARNING

DO NOT install regrooved or reinforcement repaired tires on steering axles. They could fail unexpectedly and

cause you to lose control of your vehicle resulting in an accident causing death or personal injury.

### Replacing Tires

Front: Replace front tires when less than 4/32 -in. of tread remains. Check at three places equally spaced around the tire. Drive Axles or Trailers: Replace tires on drive axles or trailers when less than 2/32 -in. of tread depth remains in any major groove. Check at three places equally spaced around the tire.



#### WARNING

DO NOT replace original equipment tires with load ratings less than the original tires. Doing so could lead to unintentional overloading of the tire, which could cause a failure resulting in loss of vehicle control and an accident. Failure to comply may result in death, personal injury, equipment or property damage.



**NOTE**

To prolong your tires' life and make them safer, have their radial and lateral run-out checked at your dealer. And of course you should have your tires balanced anytime you change a tire.

**Tire Chains**

If you need tire chains, install them on both sides of each driving axle.



**NOTE**

To prolong your tires' life and make them safer, have their radial and lateral run-out checked at your dealer. And of course you should have your tires balanced anytime you change a tire.

**Speed Restricted Tires**



**WARNING**

This vehicle is equipped with speed restricted tires. Check each tire's sidewall and/or tire manufacturer's data

book for maximum rated speed. The vehicle should not be operated at speeds in excess of the maximum rated speed. Failure to comply with these speed restrictions could cause sudden tire failure, which can result in property damage or personal injury.

**Greenhouse Gas Certified Tires**



**NOTE**

The tires installed on this vehicle at the factory as original equipment are certified for Greenhouse Gas and Fuel Efficiency regulations. Replacement tires must be of an equal or larger loaded drive tire size and an equal or lower rolling resistance level (TRRL or Crr). Consult with your tire supplier(s) for appropriate replacement tires.

In order to limit the rolling resistance of the tires and optimize fuel economy, the maintenance procedures specified by the tire manufacturer must be followed. Please see Vehicle Emissions Limited Express

Warranty for warranty on greenhouse gas certified tires.

**Wheels**

After the vehicle travels about 50 to 100 miles (80 to 160 km), wheel mountings seat in and will lose some initial torque. Check hub/wheel mountings after this initial period and retighten. Threads should be clean and dry. Do not lubricate wheel nuts or studs.



**WARNING**

Never use oil or grease on studs or nuts; improper torque readings will result, which could cause improper wheel clamping and could lead to a wheel failure resulting in an accident. Failure to comply may result in death, personal injury, equipment or property damage.

### Wheel Replacement with Disc Brake Option



**WARNING**

Use only the wheel brand, size and part number originally installed. Use of a different wheel brand or size could cause valve stem to interfere with a brake component which could lead to loss of vehicle control. Failure to comply may result in death, personal injury, equipment or property damage.

Vehicles equipped with front disc brakes are fitted with wheels designed specifically for disc brake applications. If it ever becomes necessary to replace an original equipment wheel, the replacement wheel must be the same brand and size as the take-off wheel. On vehicles equipped with 22.5 in. disc wheels, installing the wrong replacement wheel could result in the wheel valve stem making contact with the disc brake assembly. When installing any replacement wheel, always inspect the tires/wheels to ensure there is adequate clearance between other vehicle components. With the hood open, check for clearance between the wheel and disc brake assembly. Use a hydraulic jack to

raise the front of the vehicle off the ground to allow the wheel to spin freely. While rotating the wheel, check to ensure there is adequate clearance between the wheel and disc brake assembly.



**WARNING**

Improperly mounting and demounting tire and rim assemblies is dangerous. Failure to observe proper precautions could cause the tire rim assembly to burst explosively, causing death or personal injury. See the wheel manufacturer's literature for the proper way to mount and demount your tires and rims. Follow their precautions exactly.



**WARNING**

Always ensure the hood hold open latch is engaged to keep the hood fully open any time anyone gets under the hood for any reason. Failure to do so may cause the hood to close uncontrollably which may result in death or personal injury.



**WARNING**

Always support the vehicle with appropriate safety stands if it is necessary to work underneath the vehicle. A jack is not adequate for this purpose. Failure to comply may result in death, personal injury, equipment or property damage.

### Disc Wheels



**WARNING**

Use the correct components and tools when working on wheels. Grooves in the wheel disc or other damage to the disc can weaken the wheel and cause it to eventually come off. This could cause you to lose control of your vehicle, and may result in an accident. Failure to comply may result in property damage, personal injury, or death.

The end of the wheel wrench must be smooth. Burrs on the end of the wrench can tear grooves in the disc. These grooves may lead to cracks in the disc, and can cause it to fail.



## Wheel Bearings

Service the bearings, seals and oil. This interval may be different depending on the results of the regular inspection. 350,000 mi (560,000 km). For safe, reliable operation and adequate service life, your wheel bearings must be adjusted properly at the recommended intervals. Contact your authorized dealer to make sure the wheel bearings are properly adjusted.

## Tightening Wheel Cap Nuts



### WARNING

Tighten wheel cap nuts properly. If they are not tightened properly, wheel nuts could eventually cause the wheel to become loose, to fail, and/or to come off while the vehicle is moving, possibly causing loss of control and may result in death, personal injury, equipment or property damage.

### Hub Piloted Disc Wheels

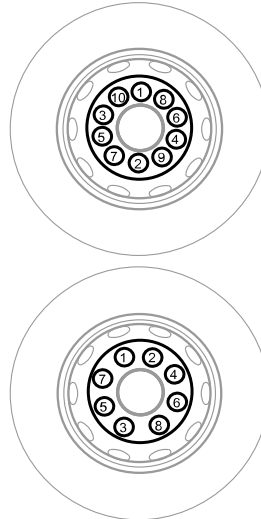

Proper wheel torque can best be obtained on level ground. Install lug nuts and finger-tighten in the numerical sequence as shown below. This procedure will ensure that the wheel is drawn evenly against the hub. Contact an authorized dealer for information on the proper installation procedure for the wheels on your truck.

This is a job you may not be able to do yourself. You need the right torquing equipment to do it.

### Stud Piloted Disc Wheels

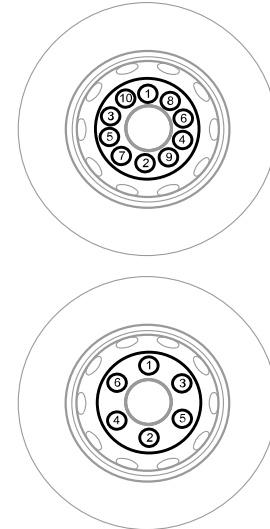

### Comparing Hub Piloted and Ball Seat Parts



#### WARNING

Do not mismatch wheel components. Equipment that does not exactly match

original specifications or that is mismatched could cause the wheels to break and separate from the vehicle. The resulting accident could be very serious. Each mounting system is engineered for use only with its correct mating part. Be sure properly matched components are used for each type of

mounting. Failure to comply may result in property damage, personal injury, or death.

The following comparison ([Comparing Hub-piloted and Ball-seat Wheels](#) on page 272), shows the difference between parts used in hub pilot mount and ball seat mount applications.

### Comparing Hub-piloted and Ball-seat Wheels

5

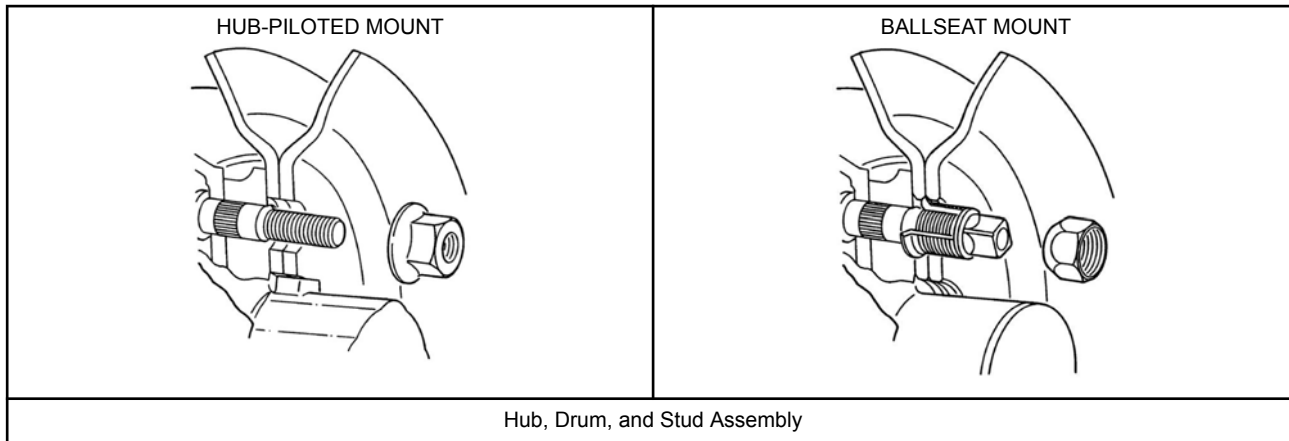

Hub-piloted mountings use M22 x 1.5 metric threads (about 7/8 in. diameter). The stud stands out at least 1.94 in. beyond the brake drum. All studs are right-hand threads. Pilot bosses (machined surfaces) on the hub, fit tightly to the wheel center bore.	Ball-seat (stud-piloted) mountings use 3/4x16 or 1-1/8x16 threads. The dual mounting studs provide 1.30 in. 1.44 in. stand-out. Right-hand and left-hand threads are required. Inner and outer wheel nuts center the wheels by seating against wheel ball seats.
Wheels	
Hub-piloted wheels have stud holes reamed straight through (no ball seats). Center bore diameter is 8-21/32 in.	Ball-seat wheels have spherical chamfers machined on each stud hole. Center bore diameter is 8-23/32 in.
Wheel Nuts	
Hub-piloted wheel nuts have a hex body and a flange for clamping against wheel face. Hex size is 1-5/16 in. (33 mm).	Ball-seat inner and outer wheel nuts mate with spherical chamfers on wheels. The inner nut has 13/16 in. square end. The outer nut has a 1-1/2 in. hex.

## Transmission Maintenance

See the transmission manufacturer's operator's manual for lubrication specifications and service intervals.

**CAUTION**

When adding oil, types and brands of oil should not be intermixed because of possible incompatibility, which could

decrease the effectiveness of the lubrication or cause component failure.

Vehicles configured with Eaton Automated or a PACCAR transmission must maintain the oil coalescing desiccant cartridge of the air dryer as part of transmission maintenance.

**CAUTION**

Replace oil-coalescing desiccant air dryer cartridge every 1 year regardless

of mileage. Only use oil-coalescing desiccant replacement cartridge when replacing. Failure to perform this maintenance task will void the PACCAR Transmission warranty and may result in expensive transmission damage.

## Hydraulic Clutch

The clutch pedal position is factory set and does not require adjustment.

### Clutch Hydraulic Fluid

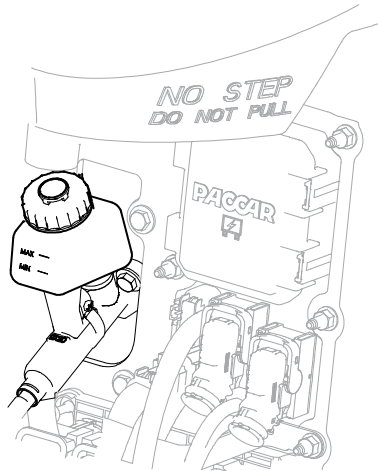

Visually inspect the clutch fluid from the reservoir. There are molded lines with the letters MIN to indicate minimum fluid level and MAX to indicate the maximum fluid level recommended for proper operation.

Be sure to maintain the fluid between the MIN and MAX levels indicated on the plastic reservoir. If the fluid level repeatedly goes below the MIN line, then it is time to have your clutch adjusted or the hydraulic system inspected for service. To replace the fluid, locate the drain fitting on the air solenoid mounted to the transmission housing. Open this fitting and allow fluid to drain out of the system. Once all the fluid is drained out, close the fitting and fill the system through the master cylinder reservoir in the engine compartment. Once the system is full, then purge the system of air by simultaneously pressing on the pedal and opening the fitting to allow air to escape. Close the fitting when fluid starts coming out. Then refill the reservoir. Repeat this until all air has been purged from the system. Replace with the recommended fluid per [Lubrication Specification Chart](#) on page 276.

#### Clutch Adjustment

Some clutches are self-adjusting, however; there are manually adjusted clutches that

will require the operator to know when to adjust the clutch. The clutch will need adjustment when your clutch pedal stroke seems to get longer and its effectiveness at a seamless shift becomes less. Another sign of the clutch needing adjustment is the level of the fluid in the reservoir. If the hydraulic fluid is not leaking, but the fluid level is getting lower, then the clutch may need to be adjusted. Please take the vehicle to an authorized dealership to have the clutch adjusted. See the clutch manufacturer's Service Manual for the proper adjustment procedures.

## Specification Reference Charts

### Pipe and Hose Clamp Torque Values

Torque specifications for engine parts.

Application	Type of Clamp	lb-in.	N-m
Radiator and Heat Exchanger Hoses	Constant Torque CT-L	90-110	10.2-12.5

Application	Type of Clamp	lb-in.	N•m
Heater Hoses	Constant Tension	not required	not required
Air Intake Pipes	Hi Torque HTM-L	100-125	11.3-14.2
Plastic Air Intake Pipes	Constant Torque CT-L	88	10.0
Charge Air Intake Hoses	Flex Seal	70-100	7.9-11.3
	B9296	50-60	6-7
Fuel, Oil and Water Heat Exchangers (for hoses less than 9/16 in. diameter).	Miniature 3600L	10-15	1.1-1.7

**Wheel Cap Nut Torque Specifications**

At the first scheduled lube interval, have all wheel cap nuts torqued to their specified

value. After that, check wheel cap nuts at least once a week. Contact an authorized dealer for information on the proper installation procedure for the wheels on your truck.

This is a job you may not be able to do yourself. You need the right torquing equipment to do it.

Wheel and Nut Configuration	Stud Size	Torque for Inner and Outer Cap Nuts and Rim Clamp Nuts	
		lb-ft	N•m
Steel or Aluminum Disc-Type Wheel; Double Cap Nut Mounting; Standard 7/8 Radius Ball Seat	3/4-16	450-500	610-680
	1-1/8-16	450-500	610-680

Wheel and Nut Configuration	Stud Size	Torque for Inner and Outer Cap Nuts and Rim Clamp Nuts	
		lb-ft	N•m
Heavy-Duty Steel Disc-Type Wheel; Double Cap Nut Mounting; 1-3/16 Radius Ball Seat:	15/16-12	750-900	1,020-1,220
	1-1/8-16	750-900	1,020-1,220
	1-15/16-12	750-900	1,020-1,220
Hub-Piloted Disc-Type Wheel w/Two Piece Flanged Cap Nuts: Steel or Aluminum Wheel PHP-10; Budd Uni-Mount-10; WDH-8	M22-1.5	450-500	610-680
Stud Backnuts (when used)	3/4-16	175-200	240-270
	1-14	175-300	240-410
Cast Spoke Wheel Assembly Rim Clamp Nut Torque	1/2 in. Dia.	80-90	110-120
	5/8 in. Dia.	160-185	220-250
	3/4 in. Dia.	225-245	305-335

**Lubrication Specification Chart**



**NOTE**

The responsibility for meeting these specifications, the quality of the prod-

uct, and its performance in service rests with the lubricant supplier.

\*Consult manufacturer or lubricant supplier for special details.

**Lubricant Symbol Key**

Type	Application
ATF	MD3 or MERCON®-approved automatic transmission fluid
BB	High temperature ball bearing grease. Chevron SRI Mobile Grease HP, Texaco Multifax 2
CB	Engine oil for mild to moderate requirements
CC/CD	Engine oil for severe requirements (MIL-L-2104B /MIL-L-45199B) w/ 1.85 % max. sulfated ash
CD	Engine oil meeting API "Five engine test sequence"
CD50	SAE 50W synthetic transmission fluid
CE	Engine oil meeting severe duty service requirements for direct-injection turbocharged
CK-4/ CJ-4	Engine oil for PACCAR MX and Cummins EGR engines
CL	Multipurpose chassis grease
EP	Extreme Pressure Lubricant (Lithium 12-hydroxystearate base NLGI 2)
GL	Straight mineral gear lubricant
HD	Hypoid Gear Oil, A.P.I. - GL-5, SAE 75W-90FE synthetic gear lubricant
HT	High Temperature grease (Timken Spec. 0-616)
MP	Multipurpose gear lubricant (MIL-L-2105B)

Type	Application
DOT3	Brake Fluid

### Component Lubrication Index

Application	Type
Steering Column	CL
Alternator Bearing	BB (1)
Fan Hub	BB (1)
Power Steering Reservoir	ATF
Steering Drag Link	CL
Steering Knuckles	CL
Spring Pins	CL
Clutch Release Bearings	BB
Brake Shoe Anchor Pins	HT
Brake Cam Bearings	HT
Slack Adjusters	CL
Starter Bearings	CC



Application	Type
Turbocharger Aneroid	CC
Water Pump	BB (1)
Suspension Fittings (other than threaded pins and bushings)	EP
Steering Axle: Grease Fittings on Steering Arm; Tie Rod Ends; Drag Link; King Pins	EP
Steering Shaft Grease Fittings	EP
Brake Treadle Hinge and Roller	Engine oil
Lock Cylinders	Lock lubricant
Door Hinges	Do not lubricate
Door Latches and Striker Plates	Polyethylene grease stick
Door Weatherstrip	Silicone lubricant
Hub-piloted Aluminum Wheels	Coat the wheel pilot or hub pads with Freylube #3 lubricant (light colored) or Chevron Zinc lube. Do not get lubricant on the face of the wheel or the hub.
Manual Transmission Hydraulic Clutch	DOT3 (Brake Fluid)
(1) Consult manufacturer or lubricant supplier for special details.	

**Frame Fastener Torque Requirements**



**CAUTION**

Incorrectly tightening the fasteners may result in failure of the fastener or incorrect clamp loads. Fastener failure may lead to frame failure. Failure to comply may result in equipment or property damage.

- Use a torque wrench for final tightening of these fasteners. Due to the coating on the threads of these bolts, be aware that if an impact gun is used to tighten the fasteners, they may over-torque and break.
- When torquing, the nut must rotate slightly before achieving the torque value. If the nut does not rotate, the fastener is over-torqued and should be replaced.
- To achieve correct clamp loads, the frame fasteners must be torqued with the nut. The intended clamp load may not be achieved if the nut is held and torque is applied to the bolt.

**Where Nylon lock-nuts are indicated in the following tables,**

- Use only ESNA Style Lock Nut, with nylon insert.
- Lubricate nylon insert nut lightly with SAE 20W or 30W oil.
- Tighten all frame fasteners with a torque wrench.



**NOTE**

The following values are applicable to fasteners on the FRAME and DO NOT APPLY to u-bolts for the suspension.

Fastener Size (-in.)	Tightening Specification lb-ft (N•m)
5/16	16-22 (22-30)
3/8	30-40 (41-54)
7/16	55-65 (75-88)
1/2	80-90 (109-122)
9/16	115-140 (156-190)
5/8	165-195 (224-265)

Fastener Size (-in.)	Tightening Specification lb-ft (N•m)
3/4	290-340 (394-462)
7/8	380-460 (517-626)
1	700-830 (952-1,129)
1-1/8	990-1,170 (1,346-1,591)
1-1/4	1,380-1,630 (1,877-2,217)

Metric Fastener Size (with NYLON insert nuts)	Tightening Specification lb-ft (N•m)
M5	6-9 (8-12)
M6	7-11 (9-15)
M8	17-23 (23-31)

**Where fasteners with all-metal lock-nuts are indicated in the following table**

- Do not lubricate these fasteners.

- Bolts and washers can be reused, but nuts can only be reused once. If in doubt, install new nuts.
- If a bolt must be replaced, then nuts and bolts must be replaced in pairs.
- Fasteners must be torqued from the nut to achieve correct clamp load.

Metric Fastener Size (with all METAL Lock-nuts)	Tightening Specification lb-ft (N•m)
M12	51-69 (69.1-93.5)
M16	125-165 (169.5-223.7)
M20	230-300 (311.8-406.8)

### Noise Control System - Maintenance Log

To ensure your vehicle's noise control requirements are maintained, record maintenance checks. Use the following log sheet and retain copies of documents regarding maintenance services performed and parts replaced on the vehicle.

Metric Fastener Size (with all METAL Lock-nuts)	Tightening Specification lb-ft (N•m)
M10	29-41 (39.4-55.6)

Component	Recommended Interval (Miles)	Date & R.O. No.	Repair Facility & Location	Work Performed	Date & R.O. No.	Repair Facility & Location	Work Performed
Exhaust System Routing Integrity	25,000						
Shutters Shrouds	25,000						
Hood Insulation Blanket	10,000						

Component	Recommended Interval (Miles)	Date & R.O. No.	Repair Facility & Location	Work Performed	Date & R.O. No.	Repair Facility & Location	Work Performed
Engine Mounted Hose Insulators Fasteners	10,000						
Inner Fender Shields	50,000						
Cab Skirts Fasteners	50,000						
Air Intake System Integrity Element	5,000						
Clutch-type Fan Drive	10,000						

authorized dealer to tighten the U-bolts on your vehicle.

**Suspension U-Bolts, Grade 8**

Tighten all U-bolts with a torque wrench. Torque requirements in the table below apply to PACCAR proprietary suspensions using Protec Torque/TEXO coated U-bolts, only. For all other suspensions, follow the manufacturer's recommended torque values. PACCAR proprietary suspension u-bolts must be tightened in a specific sequence. Take your vehicle to an

**Torque for Grade 8 U-Bolts**

Peterbilt Front Suspension U-bolts		
U-Bolt Size Diameter (- in.)	Torque (lb-ft)	Torque (N•m)
3/4	260-290	353-393
7/8	370-415	502-563

Peterbilt Front Suspension U-bolts		
U-Bolt Size Diameter (-in.)	Torque (lb-ft)	Torque (N•m)
For all non-PACCAR suspension systems, see the manufacturer's operator's manual for torque specifications.		

Peterbilt Rear Suspension U-bolts		
Rear Suspension Type	U-Bolt Diameter	Torque lb-ft (N•m) <sup>28</sup>
Low Air Leaf (U-bolt, spring)	M22 x 1.5	375–475 (508–644)
Flex Air	M22 x 1.5	325–375 (440–508)
Tandem Low Air Leaf	M22 x 1.5	375–475 (508–644)
Air Leaf (U-bolt, spring)	1.0 -in. NF	450–550 (610–746)

Peterbilt Rear Suspension U-bolts		
Rear Suspension Type	U-Bolt Diameter	Torque lb-ft (N•m)
Air-Trac	1.0 -in. NF	450–550 (610–746)
13.5K Taper Leaf (Axle U-bolt)	¾ -in. 16 UNF	275–320 (373–434)
18K Taper Leaf (Axle U-bolt)	¾ -in. 16 UNF	275–320 (373–434)
18K Air Leaf (Axle U-bolt)	¾ -in. 16 UNF	275–320 (373–434)
For all non-PACCAR suspension systems, see the manufacturer's operator's manual for torque specifications.		



**NOTE**

The values shown here are for suspension U-bolts and should not be applied to bolts and fasteners for the frame.

**Vehicle Light Bulb Specifications**

Bulb Location	Type of Bulb	Notes
Low beam/ High beam headlight	9007LL (SAE)	Dual Filament Bulb
Daytime running light/ Parking light	4157K (SAE)	Dual Filament Bulb

Bulb Location	Type of Bulb	Notes
Turn Signal/ Side Marker Light/ Side Turn Indicator	4157K (SAE)	Dual Filament Bulb
Stop/ Tail turn	1157 BULB or LED	N/A
Backup	1156 BULB or LED	N/A
Rear Tail Light/ Turn Signal	N/A	LED
Roof Markers	N/A	LED
Hood Markers	N/A	LED
License Light	N/A	LED
Interior Map Light	N/A	LED
Interior Dome Light	N/A	LED

Bulb Location	Type of Bulb	Notes
Interior Ambient Light	N/A	LED
Warning lamp module	#37 or 73 (T1 3/4 wedge base)	N/A

### Rear Suspension Fasteners

Torque requirements apply to manufacturer proprietary suspensions. All other suspensions must refer and adhere to original manufacturer's shop manual.

SIZE/TYPE	TORQUE	
	lb-ft	N•m
M16	125-165	169.5-223.7
M20 all- metal lock nuts	315-350	427-475

SIZE/TYPE	TORQUE	
	lb-ft	N•m
1/2 -in. nut	80-90	109-122
3/4 -in. nut	290-340	394-462
1-1/4 -in. nut	1,380-1,630	1,877-2,217

### Air Leaf Fastener Torque Values

Fastener	Fastener Name	Torque lb-ft (N•m)
1 NF x 8.5"	Spring eye bolt	225-550 (305-746)
0.75 NC x 2.25"	Alignment cap screw	208-296 (282-401)
0.75 NF	Spring eye U-bolt (rolled threads)	50-100 (68-136)
0.75 NC x 5.0"	Spring eye clamp bolt	165-210 (68-136)

Fastener	Fastener Name	Torque lb-ft (N•m)
0.75 NF	Spring center bolt	165–210 (224–285) <sup>29</sup>
1 NF	U-bolt, spring <sup>30</sup>	Refer to section on Suspension U-Bolts, Grade 8.
0.5 UNC	Air bag stud nut	40–50 (54–68)
M16	Tracking rod bolts	155–195 (210–264)

**Air-Trac Fastener Torque Values**

Fastener	Fastener Name	lb•ft (N•m)
M16	Tracking rod bolts	155–195 (210–264)
0.75 NF	Spring center bolt	165–210 (224–285) <sup>31</sup>
M16 0.75 NF	Radius rod bolts (forward)	155–195 (210–264)
	Radius rod bolts (at axle)	250–350 (339–475)
M16	Frame bracket bushing bolts	50–65 (68–88)

Fastener	Fastener Name	lb•ft (N•m)
1.0 NF	U-bolt <sup>32</sup>	Refer to section on Suspension U-Bolts, Grade 8.
0.5 UNC	Air bag stud nut	40–50 (54–68)
M16	Tracking rod bolts	155–195 (210–264)

<sup>29</sup> Torque requirement applies at subassembly of air spring support and leaf spring only.

<sup>30</sup> PACCAR proprietary suspension U-bolts must be tightened in a specific sequence. Take your vehicle to an authorized dealer to tighten the U-bolts on your vehicle.

<sup>31</sup> Torque requirement applies at subassembly of airspring support and leaf spring only.

<sup>32</sup> See owners manual for torque tightening sequence.

**Flex Air Fastener Torque Values**

Fastener	Fastener Name	Torque lb-ft (N•m)
M16	Drive bracket - frame bolts	155–195 (210–264)
	Drive bracket - link spring bolt	
	Drive bracket - radius rod bolt	
	Drive beam - shock bolt (lower)	
	Shock bracket - shock bolt (upper)	

Fastener	Fastener Name	Torque lb-ft (N•m)
	Tracking rod bolts (all)	
M10	Air spring support beam bolts	36–51 (49–69)
0.88 - 14 UNF	Drive beam - link spring bolt	380–460 (515–624)
0.88 - 14 UNF	Radius rod bracket bolt	380–460 (515–624)
M22 x 1.5	U-bolt <sup>33</sup>	Refer to section on Suspension U-Bolts, Grade 8.
0.5 UNC	Air bag stud nut	40–50 (54–68)

**Low Air Leaf Torque Values**

Low Air Leaf Torque values apply to both single and tandem axles.

Fastener	Fastener Name	Torque lb-ft (N•m)
M20 x 2.5	Bar pin bolts	325–425 (441–576)
M22 x 1.5	U-bolt, spring <sup>34</sup>	Refer to section on Suspension U-Bolts, Grade 8.
0.5 UNC	Air bag stud nut	40–50 (54–68)
M16	Tracking rod bolts	155–195 (210–264)

<sup>33</sup> Contact your dealer for torque tightening procedure.

<sup>34</sup> Contact your dealer for torque tightening procedure.



**18K Taper Leaf Torque Values**

Fastener	Fastener Name	Torque lb•ft (N•m)
M20	Spring Pivot Eye Bolt	260–340 (353–461)
0.75 UNF	Axle U-bolt <sup>35</sup>	Refer to section on Suspension U-Bolts, Grade 8.
M16	Shock Bolts	120–160 (163–217)

**13.5K Taper Leaf Torque Values**

Fastener	Fastener Name	Torque lb•ft (N•m)
M20	Spring Pivot Eye Bolt	260–340 (353–461)
0.75 UNF	Axle U-bolt <sup>36</sup>	Refer to section on Suspension U-Bolts, Grade 8.
M16	Shock Bolts	120–160 (163–217)

**18K Air Leaf Torque Values**

Fastener	Fastener Name	Torque lb•ft (N•m)
M20	Spring Pivot Eye Bolt	260–340 (353–461)
0.75 UNF	Axle U-bolt <sup>37</sup>	Refer to section on Suspension U-Bolts, Grade 8.
M16	Track Rod, Shock Bolts	120–160 (163–217)
0.5 UNC	Air Spring Stud Nut	40–50 (54–68)

<sup>35</sup> Contact your dealer for torque tightening procedure.

<sup>36</sup> Contact your dealer for torque tightening procedure.

<sup>37</sup> Contact your dealer for torque tightening procedure.

## Chapter 6 | INFORMATION

Consumer Information.....	289
Vehicle Identification Labels.....	289
Clean Idle.....	292
Greenhouse Gas Certified Configuration.....	293
Vehicle Emissions Limited Express Warranty.....	296

## Consumer Information

### How to Order Replacement Parts

Replacement parts may be obtained from an authorized dealership. When you order, it is **IMPORTANT** that you have the following information ready:

- Your name and address
- Serial number of the truck
- The name of the part you need
- The name and number of the component for which the part is required
- The quantity of parts you need
- How you want your order shipped

### National Highway Traffic and Safety Administration (NHTSA)

If you believe that your vehicle has a defect, which could cause a crash or could cause death or personal injury, you should immediately inform the National Highway Traffic Safety Administration (NHTSA) in addition to notifying the vehicle manufacturer. If NHTSA receives similar complaints, it may open an investigation, and if it finds that a safety defect exists in a group of vehicles, it may order a recall and

remedy campaign. However, NHTSA cannot get involved in individual problems between you, your dealer, and vehicle manufacturer. Contacting NHTSA is possible through telephone, written mail and email. NHTSA also has a website where you can input your comments directly to them on the web. Please use any of the four ways to contact NHTSA:

Toll Free 1-888-327-4236 (800-424-9153  
TTY) 8:00 a.m. to 10:00 p.m. EST  
Monday-Friday

Office of Defects Investigations/CRD  
NV5-216 1200 New Jersey Ave. SE  
Washington, D.C. 20590

[www.safercar.gov](http://www.safercar.gov)

email: [nhtsa.webmaster@dot.gov](mailto:nhtsa.webmaster@dot.gov)

### Transport Canada

Canadian customers who wish to report a safety-related defect to Transport Canada, Defect Investigations and Recalls, may telephone the toll free hotline 1-800-333-0510, or contact Transport Canada by mail at:

Transport Canada, ASFAD Place de Ville  
Tower C 330 Sparks St. Ottawa, ON K1A  
0N5

For additional road safety information,  
please visit the Road Safety website at:  
<http://www.tc.gc.ca>

## Vehicle Identification Labels

Each vehicle completed by Peterbilt Motors Company uses a vehicle identification number (VIN) that contains the model year designation of your vehicle. The practice is in compliance with 49 CFR 565, Code of Federal Regulations.

The full, 17-digit VIN is located on the Weight Rating Data Label. The label is located on the driver's side door edge or on the driver's side door frame.

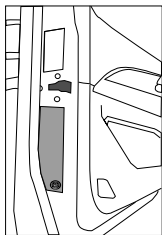
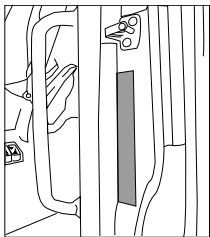

- Back of cab, left-hand rear panel, lower edge
- Tire, Rim, and Weight Rating Data label (truck)
- Components and Weights label
- Noise Emission label
- Paint Identification label

### Certification Labels

Your vehicle information and specifications are documented on labels. As noted below, each label contains specific information pertaining to vehicle capacities and specifications that you should be aware of.

### Components and Chassis Weight Label

The Components and Chassis Weight Label is located on either the driver's side door edge or on the driver's side door frame. It includes chassis number, chassis weight and gross weight, plus model information for the vehicle, engine, transmission, and axles.

### Tire, Rim and Weight Rating Data Label

The Tire, Rim, and Weight Rating Data Label is located on the driver's side door

edge or on the driver's side door frame. It contains the following information:

- GVWR - Gross Vehicle Weight Rating
- GAWR FRONT, INTERMEDIATE and REAR - Gross Axle Weight Ratings for Front, Intermediate and Rear Axle
- TIRE/RIM SIZES AND INFLATION PRESSURES - Tire/Rim Sizes and Cold Pressure Minimums
- VIN including CHASSIS NUMBER.

The components of your vehicle are designed to provide satisfactory service, if the vehicle is not loaded in excess of either the gross vehicle weight rating (GVWR), or the maximum front and rear gross axle weight ratings (GAWRs).



### WARNING

DO NOT exceed the specified load rating. Overloading can result in loss of vehicle control, either by causing component failures or by affecting vehicle handling. Exceeding load ratings can also shorten the service life of the vehicle. Failure to comply may result in death or personal injury.

### Chassis Number

The Chassis Number refers to the last six characters of the VIN. This number will allow your dealer to identify your vehicle. You will be asked for this number when you bring it in for service. Chassis Number Locations

- Right frame rail, top flange, about 3 ft. from the front end

 <b>NOTE</b>
<p>GVW is the TOTAL SCALE WEIGHT the vehicle is designed to carry. This includes the weight of the empty vehicle, loading platform, occupants, fuel, and any load.</p>

**Noise Emission Label**

The Noise Emission Label is located in the driver's side door frame. It contains information regarding U.S. noise emission regulations, chassis number, and date of manufacture.

**Paint Identification Label**

The Paint Identification Label contains the paint colors used by the factory to paint your vehicle. It lists frame, wheels, cab interior and exterior colors. This label is located inside the glove box.

**Federal Safety Standard Certification Label**

The NHTSA regulations require a label certifying compliance with Federal Safety Standards, for United States and U.S. Territories, be affixed to each motor vehicle and prescribe where such label may be located. This certification label, which

indicates the date of manufacture and other pertinent information, is located on the driver's side door edge or on the driver's side door frame.

**Component Identification**

Each of the major components on your vehicle has an identification label or tag. For easy reference, record component numbers such as, model, serial, and assembly number.

Engine	For further information, please refer to the Engine Operation and Maintenance Manual.
Transmission	For both manual and automatic transmissions, the identification number is stamped on a tag affixed to the right rear side of the transmission case.
Clutch	Enclosed in clutch housing. Location depends on manufacturer.
Steer Axle	The front axle serial number is stamped on a plate located on the center of the axle beam.
Axle Specification Number	Usually stamped on the right rear side of the axle housing. This number identifies the complete axle.
Axle Housing Number	Usually located on the left forward side of the housing arm. This tag identifies the axle housing.

Axle Differential Carrier Identification	Usually located on the top side of the differential carrier. The following information is either stamped, or marked with a metal tag: Model No., Production Assembly No., Serial No., Gear Ratio, and Part Number.
--	--

## Clean Idle

To comply with CARB emissions requirements, your vehicle will either have the Certified Clean Idle label or an Engine Shutdown System (ESS). Some vehicles, however, are exempt from these requirements because of their configurations (for example: fire truck service).

Your vehicle may have either of these labels affixed to the vehicle to identify that its engine meets the strict low exhaust emission regulations instituted by the state of California (and other states that have chosen to adopt CARB emissions requirements). Trucks with this type of engine will not require an Engine Shutdown System and will be allowed to idle continuously. It is important that you do not remove or deface this label. Do not block it from view. Please contact your authorized dealership if you need to replace this label. The dealership will be

able to help you to determine whether or not your vehicle's engine may be a candidate for a Certified Clean Idle label if it did not already have the label. If you have a PACCAR PX-7 or PX-9 engine, your label will look like the image below.



If you have a Cummins engine, your label will look like the image below.



## Engine Shutdown System

If the vehicle's engine does not meet the low exhaust emission standard it will have an Engine Shutdown System (ESS) to meet limited idle regulations implemented by CARB and some additional states. These regulations require that the engine have an automatic system to restrict the idle time on certain vehicles. An Engine Shutdown System will shut down the engine after 5 minutes if the vehicle idles with the park brake set and the transmission in 'neutral' or 'park'. The ESS will also allow the vehicle 15 minutes of idle time if the driver does not set the park brake and shifts the transmission to 'neutral' or 'park'. The ESS, however, will not shut down the engine if the engine is operating in Power Take Off (PTO) mode, if the engine coolant is below 60 degrees Fahrenheit, or if the engine is performing a parked regeneration. The check engine light will alert you when the ESS shutdown timer reaches the last 30 seconds before the engine shuts down. The last 30 seconds prior to engine shutdown is the

only time the driver may reset the idle time by pressing on the accelerator. More detailed information may be available in the Engine Operator's Manual provided with your vehicle.

ject to fines and penalties. Please contact the vehicle manufacturer for further information about this vehicle's certified configuration.

regulatory subcategory

## Greenhouse Gas Certified Configuration

This vehicle includes Greenhouse Gas (GHG) regulated parameters and technologies. A Vehicle Emission Control Information label is located on the driver's door with codes that partially identify the vehicle's GHG certified configuration. In addition to the Vehicle Emission Control Information label, other technologies that reduce GHG emissions and regulated parameters included in the vehicle's GHG certified configuration are described in this section.

**i** NOTE  
 Modifying a vehicle's certified configuration without good engineering judgment or PACCAR's approval may be a violation of the Clean Air Act and sub-

### Vehicle Emission Control Information Label Descriptions

Label Identifiers	Label Identifier Descriptions
Family Name	Describes the vehicle's certified manufacturer, regulatory category, and regulatory subcategory
Emission Controls	Describes regulated emission control devices installed on the vehicle
Compliance Statement	Describes the vehicle's compliance standards
Regulatory Subcategory	Describes the vehicle's certified

Emission Controls	Emission Control Descriptions
ARF	Aerodynamic roof fairing
ARFR	Adjustable height aerodynamic roof fairing
ATS	Aerodynamic side skirt and/or fuel tank fairing
AFF	Aerodynamic front fairing
AREF	Aerodynamic rear fairing
TGR	Gap reducing fairing
LRRA	Low rolling resistance tires (all)

LRRD	Low rolling resistance tires (drive)
LRRS	Low rolling resistance tires (steer)
VSL	Vehicle speed limiter
VSLS	Soft-top vehicle speed limiter
VSLE	Expiring vehicle speed limiter
VSLD	Vehicle speed limiter with both soft-top and expiration
IRT	Engine shutoff system
IRT5	Engine shutoff after 5 minutes or less of idling
IRTE	Expiring engine shutoff
ADVH	Vehicle includes advanced hybrid

	technology components
ADVO	Vehicle includes other advanced-technology components
INV	Vehicle includes innovative (off-cycle) technology
ATI	Automatic tire inflation system
TPMS	Tire pressure monitoring system

**GHG Regulated Technology Not On the Emission Control Information Label**

Technology	Compliance Requirements
Wheel-Related Weight Reduction	Wheel-related weight reduction benefits may be included in this vehicles certified

	configuration. Changing aluminum wheels to a steel wheels may be a violation of the Clean Air Act and subject to fines and penalties.
Nonwheel-Related Weight Reduction	Nonwheel-related weight reduction benefits may be included in this vehicles certified configuration. Changing aluminum material to steel material may be a violation of the Clean Air Act and subject to fines and penalties.



Idle Reduction

This vehicle may be equipped with factory installed automatic engine shutdown (AES), neutral idle, start-stop systems, intelligent controls (Predictive Cruise Control and Neutral Coast), or extended idle reduction systems (Engine Idle Shutdown Timer, Engine Auto Start, SmartAir, Fuel-Fire Sleeper Heater System). Disabling or modifying any idle reduction system may be a violation of the Clean Air Act and subject to fines and penalties.

**GHG Regulated Powertrain Parameters Not On the Emission Control Information Label**

Powertrain Components	Regulated Parameters
Engine	Engine idle speed, torque, horsepower, and governed RPM
Transmission	Lock up gear, number of gears, and torque converter
Axle	Configuration and drive axle ratio

**GHG Regulated Aerodynamic Performance**

The vehicle needs to stay in as-built aerodynamic performance unless good engineering judgment shows that the modification will improve safety or will not increase greenhouse gases.

**GHG Regulated Air Conditioning Leakage Standards**

Loss of refrigerant from the air conditioning systems may not exceed a total leakage rate of 11.0 grams per year or a percent leakage rate of 1.50 percent per year, whichever is greater. This vehicle was built to meet this air conditioning leakage standards. Any modification of the air conditioning system must comply with leakage rates defined in SAE J2727.



**NOTE**

Modifying a vehicle's certified configuration without good engineering judgment or PACCAR's approval may be a violation of the Clean Air Act and subject to fines and penalties. Please contact the vehicle manufacturer for further information about this vehicle's certified configuration.

## Vehicle Emissions Limited Express Warranty

### Original Equipment Tires

PACCAR Inc. warrants the tires installed as original equipment on this vehicle only against defects in materials and workmanship which cause the vehicle to fail to comply with applicable U.S. and Canadian greenhouse gas emission limits ("Warrantable Emissions Failures"). This vehicle emissions limited express warranty relating to original equipment tires is valid for two (2) years or 24,000 miles (38,000 km), whichever occurs first. YOUR SOLE AND EXCLUSIVE REMEDY AGAINST PACCAR Inc. IS LIMITED TO THE REPAIR OR REPLACEMENT OF ORIGINAL EQUIPMENT TIRES, SUBJECT TO PACCAR'S TIME AND MILEAGE LIMITATIONS LISTED ABOVE. This Vehicle Emissions Limited Express Warranty relating to original equipment tires begins on the date of delivery of the vehicle to the first purchaser or lessee and accrued time and mileage is calculated when the vehicle is brought in for correction of the Warrantable Emissions Failures relating to the original equipment

tires. PACCAR MAKES NO OTHER VEHICLE EMISSIONS WARRANTIES RELATING TO THE ORIGINAL EQUIPMENT TIRES, EXPRESS OR IMPLIED. WHERE PERMITTED BY LAW, PACCAR EXPRESSLY DISCLAIMS ANY WARRANTY OF MERCHANTABILITY OR FITNESS FOR A PARTICULAR PURPOSE RELATING TO VEHICLE EMISSIONS. PACCAR AND THE SELLING DEALER SHALL NOT BE LIABLE FOR INCIDENTAL OR CONSEQUENTIAL DAMAGES INCLUDING, BUT NOT LIMITED TO: LOSS OF INCOME OR LOST PROFITS; VEHICLE DOWNTIME; COMMUNICATION EXPENSES; LODGING AND/OR MEAL EXPENSES; FINES; APPLICABLE TAXES OR BUSINESS COSTS OR LOSSES; ATTORNEY'S FEES; AND ANY LIABILITY YOU MAY HAVE IN RESPECT TO ANY OTHER PERSON OR ENTITY RELATING TO WARRANTABLE EMISSIONS FAILURES. This Vehicle Emissions Limited Express Warranty relating to original equipment tires is limited to emissions compliance only. The tires are separately warranted by their manufacturer for defects in materials and workmanship other than those which cause non-compliance with

U.S. and Canadian GHG regulations, subject to limitations and conditions contained within the tire manufacturer's warranty agreement. You are responsible for the safe operation and maintenance of the vehicle and its tires. PACCAR does not warrant wear and tear of the tires.

### Greenhouse Gas (GHG) Components Other Than Tires

This GHG vehicle Warranty applies to the vehicle (hereafter, vehicle) certified with the US Environmental Protection Agency.

### Your Warranty Rights and Obligations

This vehicle is warranted for components that directly impact the manufacturers GHG certification with the US Environmental Protection Agency. PACCAR must warrant these components for the periods of time listed below provided there has been no abuse, neglect or improper maintenance of the vehicle. If a GHG-related part on your vehicle is found to have a defect in material or assembly, the part will be repaired or replaced by PACCAR.

## Manufacturer's Warranty Coverage

This warranty coverage is provided for five years or 100,000 miles (160,000 km), whichever occurs first, from the date of delivery of the vehicle to the first purchaser or first lessee. Where a Warrantable Condition exists, PACCAR will diagnose and repair the vehicle, parts and labor included, at no cost to the first purchaser or first lessee and each subsequent purchaser or lessee. This warranty does not override any extended warranty purchased to cover specific vehicle components.

## Owner's Warranty Responsibilities

The vehicle owner is responsible for performing required maintenance that is listed in your engine and vehicle Operator's Manuals. The owner is responsible for presenting the vehicle to a service location as soon as a problem exists. Any warranty repairs should be completed in a reasonable amount of time. Retain all receipts covering maintenance on this equipment. PACCAR cannot deny warranty solely for the lack of receipts or for the failure to ensure the performance of all scheduled maintenance. PACCAR may deny warranty coverage if a vehicle

component has failed due to abuse, neglect, improper maintenance, unapproved modifications (both physical components and computer programming) or using non-Original Equipment replacement parts. If there are any questions regarding these warranty rights and responsibilities, please contact the vehicle OEM manufacturer at the customer center telephone number provided with the vehicle operating instructions. Prior to the expiration of the applicable warranty, Owner must give notice of any warranted failure to an authorized PACCAR dealer and deliver the vehicle to such facility for repair. Owner is responsible for incidental costs such as: communication expenses, meals, lodging incurred by Owner or employees of Owner as a result of a Warrantable Condition. Owner is responsible for downtime expenses, cargo damage, fines, all applicable taxes, all business costs, and other losses resulting from a Warrantable Condition. Owner is responsible for maintaining all emissions related engine and vehicle computer program settings in accordance with manufacturer specifications. This responsibility includes GHG specific settings that may not be altered before the GHG-related expiration mileage has been

reached for each system. Owner is responsible for maintaining all physical parts related to GHG-regulations in the as-built configuration and in proper working order for the full regulatory useful life of 435,000 miles (700,000 km) or 10 years for Class 8 vehicles, 185,000 miles (300,000 km) or 10 years for Class 5-7.

## Replacement Parts

PACCAR recommends that any service parts used for maintenance, repair or replacement of GHG components be new or genuine approved rebuilt parts and assemblies. The use of non-genuine engine or vehicle replacement parts that are not equivalent to the PACCAR engine or OEM vehicle manufacturer's original part specification as built from the factory may impair the engine and vehicle emissions control system from working or functioning effectively, and may jeopardize your GHG warranty coverage. In addition, genuine vehicle or engine parts must be replaced with the same material and function as the part assembled on the vehicle from the factory. The owner may elect to have maintenance, replacement or repair of the emission control parts performed by a facility other than an authorized PACCAR dealer and may elect

to use parts other than new or genuine approved rebuilt parts and assemblies for such maintenance, replacement or repair; however, the cost of such service or parts and subsequent failures resulting from such service or parts may not be fully warranted if the manufacturer determines that the replacement part is not of similar material and function as the OEM part assembled to the vehicle at the factory.

### **PACCAR Responsibilities**

The warranty coverage begins when the vehicle is delivered to the first purchaser or first lessee. Repairs and service performed by any authorized PACCAR dealer using new or genuine approved rebuilt parts and assemblies will utilize replacement parts that are selected and installed to support the GHG compliance certification. PACCAR will repair parts found by PACCAR to be defective without charge for parts or labor (including diagnosis which results in determination that there has been a failure of a warranted part).

### **Warranty Limitations**

Sole and exclusive remedy against PACCAR and the Selling Dealer arising from the purchase and use of this vehicle is limited to the repair or replacement of

"warrantable failures", for replacement parts that are similar in material and function to OEM specifications and subject to PACCAR's time, mileage, and hour limitations of the greenhouse gas warranty. The maximum time, mileage and hour limitations of the warranty begin with the Date of Delivery to the first purchaser or first lessee. The accrued time, mileage, or hours is calculated when the vehicle is brought in for correction of warrantable failures. PACCAR is not responsible for failures or damage resulting from what PACCAR determines to be abuse, neglect or uncontrollable acts of nature, including, but not limited to: damage due to accident; operation without adequate coolants or lubricants; overfueling; overspeeding; lack of maintenance of cooling, lubricating or intake systems; improper storage, starting, warm-up, run-in or shutdown practices; unauthorized modifications to the vehicle and its components. PACCAR is also not responsible for failures caused by incorrect oil, fuel or diesel exhaust fluid or by water, dirt or other contaminants in the fuel, oil or diesel exhaust fluid. Failure of replacement parts used in repairs due to the above non-warrantable conditions is not warrantable. This warranty is void if the vehicle is altered with parts that do not meet the

material and functional specifications as manufactured from the factory. Any alterations to vehicle or engine computer settings will void GHG warranty and potentially cause the vehicle to become non-compliant with EPA Clean Air Act GHG regulations. Any alterations to GHG specific settings prior to the GHG related expiration mileage for each system will void GHG warranty and potentially cause the vehicle to become non-compliant with EPA Clean Air Act GHG regulations. This warranty is void if certain GHG components are not properly maintained and thus cannot perform to their designed capability. PACCAR is not responsible for failures resulting from improper repair or the use of parts which are not genuine approved parts. PACCAR is not responsible for the material and labor costs of emission control parts and assemblies replaced during Scheduled Maintenance of the engine as specified in PACCAR Operator's Manuals. THIS WARRANTY, TOGETHER WITH THE EXPRESS COMMERCIAL WARRANTIES ARE THE SOLE WARRANTIES MADE BY PACCAR IN REGARD TO THIS VEHICLE. THIS LIMITED GHG WARRANTY IS THE SOLE WARRANTY MADE BY PACCAR AND THE SELLING DEALER. EXCEPT FOR

THE ABOVE LIMITED WARRANTY, PACCAR AND THE SELLING DEALER MAKE NO OTHER WARRANTIES, EXPRESS OR IMPLIED. PACCAR AND THE SELLING DEALER EXPRESSLY DISCLAIM ANY WARRANTY OF MERCHANTABILITY OR WARRANTY OF FITNESS FOR A PARTICULAR PURPOSE. PACCAR AND THE SELLING DEALER SHALL NOT BE LIABLE FOR INCIDENTAL OR CONSEQUENTIAL DAMAGES INCLUDING, BUT NOT LIMITED TO: LOSS OF INCOME OR LOST PROFITS; ENGINE OR VEHICLE DOWNTIME; THIRD PARTY DAMAGE, INCLUDING DAMAGE OR LOSS TO OTHER ENGINES, VEHICLES OR PROPERTY, ATTACHMENTS, TRAILERS AND CARGO; LOSS OR DAMAGE TO PERSONAL CONTENTS; COMMUNICATION EXPENSES; LODGING AND/OR MEAL EXPENSES; FINES; APPLICABLE TAXES OR BUSINESS COSTS OR LOSSES; ATTORNEYS' FEES; AND ANY LIABILITY YOU MAY HAVE IN RESPECT TO ANY OTHER PERSON OR ENTITY.

# Glossary

**Anti-lock Braking System** - A federally mandated anti-skid braking device used on cars and trucks.

**Low Voltage Disconnect** - An electronic system that will disconnect or turn off electrical systems when a preset voltage is reached on the batteries caused by too much electrical drain from appliances or heaters inside the sleeper.

**Adaptive Cruise Control** - An electronic system that automatically adjusts the speed of a truck in cruise control to a predetermined following distance and/or time. This feature includes a warning system to warn the driver for collision avoidance.

**Predictive Cruise Control** - An optional cruise control function that increases or decreases vehicle speed based on geographical terrain.



# Index

## Numerics

18K Taper Leaf Suspension Rear Suspension Fasteners [287](#)

## A

ABS Warning Lamp [135](#), [141](#)  
Accessories [111](#)  
Active Cruise Control Set Following Distance [127](#)  
Active Warnings [70](#)  
Adaptive Cruise Control [126](#)  
Adaptive Cruise Control Notification, *See* ADAS Notification  
ADAS, *See* Driver Assistant  
ADAS Notification [68](#)  
Adding Coolant, *See* How to Add Coolant to the Cooling System  
Adding Electrical Options [234](#)  
Additives to Cooling System [225](#)  
Adjust Side Mirrors [101](#)  
Advanced Driver Assistant System, *See* Driver Assistant  
Aiming Headlamps [232](#)  
Air Brake System [135](#)  
Air Conditioner [104](#)  
Air Conditioner Defrost Windshield [109](#)  
Air Disc Brakes [212](#)  
Air Dryer Maintenance [206](#)  
Air Filter Restriction Indicator [128](#)  
Air Gauges and Air Leaks [209](#)  
Air Intake System [245](#)  
Air Leaf Fastener Torque Value Rear Suspension Fasteners [284](#)  
Air Ride Height Data [155](#)  
Air Tanks [208](#)  
Air-Controlled Sliding Fifth Wheel [159](#)  
Air-Operated Kingpin Release, *See* How to Release the Kingpin from the Cab

Air-Trac Fastener Torque Value Rear Suspension Fasteners [285](#)  
Allison Transmission Lubrication [200](#)  
Alternator [240](#)  
Anti-Lock Brake System (ABS) [55](#)  
Anti-Lock Brake System (ABS), Trailer [55](#)  
Anti-Theft [68](#)  
Appliances [113](#)  
Ashtray, *See* Cigarette Lighter and Ashtray  
Automatic Slack Adjuster Stroke Specification [214](#)  
Axle, Automatic Traction Control [86](#)  
Axle, Traction Control [56](#), [57](#), [142](#)  
*See also* ATC  
Axle Auxiliary [151](#)  
Axle Diff Lock [147](#)  
Axle Differential Lock [147](#)  
Axle Dual Range [149](#)  
Axle Pusher Tag [151](#)  
Axle Two Speed [149](#)

## B

Batteries [236](#)  
Batteries, Low Voltage Disconnect (LVD) [87](#)  
Battery, Jump Start [34](#)  
Before You Leave the Cab [137](#)

## Belt

Komfort Latch [22](#)  
Lap/Shoulder [20](#)  
Safety [18](#)  
Tether [21](#)  
Bendix® AD-HF Series Air Dryer [207](#)  
Brake Components [140](#)  
Brake Fluid Check and Refill [215](#)  
Brake Operation [144](#)



Brake Safety and Emergency [141](#)  
Brake System [211](#)  
Brake Warning Lamp [142](#)  
Brake, ParkingManual release [37](#)  
Brakes, ABS Off-Road [88](#)  
Bulb Check [68](#)

## C

### Cab

How to Lock and Unlock the Doors [13](#)  
Cab Air Filter [222](#)  
Cab and Panel Dimmer Switch [89](#)  
Cab HVAC Fresh Air Filter Replacement [222](#)  
Cab Maintenance [217](#)  
Cabin Fresh Air Filter [256](#)  
CAN bus [235](#)  
Care of Display Screens on the Dashboard [223](#)  
CD Player, *See* Stereo Radio  
Charger, *See* Dual USB Charger  
Check Engine Lamp Turns On [30](#)  
Check Engine Oil Level [242](#)  
Check Transmission [57](#)  
Cigarette Lighter and Ashtray [112](#)  
Circuits Disconnected by LVD [88](#)  
Cleaning LCD Display Screens [223](#)  
Collision Alerts Driver Screens [126](#)  
Comparing Hub Piloted and Ball Seat Parts [272](#)  
Coolant fill [227](#)  
Coolant level [227](#)  
Cooling system maintenance [225](#)  
Cooling System Overheating [31](#)  
Cranking Battery Specification [238](#)  
Cruise ControlCancel [126](#)  
Cruise ControlChange Set Speed [125](#)  
Cruise ControlResume Set Speed [126](#)  
Cruise ControlSet Speed [125](#)  
Cruise ControlStandard [124](#)  
Custom [72](#)  
Custom Setup [72](#)

Custom View, *See* Custom

## D

Daily Checks [24](#)  
Dana Spicer and Fabco [263](#)  
Dash Brightness, *See* Cab and Panel Dimmer Switch  
Dash Switches [77](#)  
Dashboard Display Screen [223](#)  
Diesel Exhaust Fluid Tank [260](#)  
Diesel Particulate Filter (DPF) Warning Light [58](#)  
Differential, Inter-Axle Lock [58](#)  
Dimmer Switch, *See* Cab and Panel Dimmer Switch  
Display Notifications [69](#)  
Dome LightLights [113](#)  
Door Mounted Mirror Controls [101](#)  
Draining the Primary Fuel Filter [249](#)  
Drive Axle - Dana [263](#)  
Drive Axle - Meritor [263](#)  
Driver Assistant [74](#)  
Driver Controlled Main Differential Lock [149](#)  
Drum Brake Inspection [214](#)  
Dual Air System Function Test [206](#)  
Dual Range (Two-Speed) Rear Axle [149](#)  
Dual USB Charger [112](#)  
Dump Truck, Body Up [58](#)  
Dump Truck, Trailer Body Up [58](#)

## E

Eaton/Dana Axle Lubrication [202](#)  
Electric Steer Assist [127](#)  
Electrical System [232](#)  
ELS, *See* Exterior Lights Switch  
ELST, *See* Exterior Lights Self-Test  
Emergency Brake, *See* Parking Brake  
Emergency Braking [142](#)  
Emissions [123](#)  
Emissions Engine Derate [60](#)

# Index

---

Emissions, High Exhaust System Temperature [60](#)  
Engine Aftertreatment System [123](#)  
Engine Air filter [246](#)  
Engine Air Filter Pre-Cleaner [247](#)  
Engine Air Filters [246](#)  
Engine Brake [96](#)  
Engine Brake IndicatorEngine Brake Operation [147](#)  
Engine Brakes [146](#)  
Engine BrakeSaver or Transmission Retarder [58](#)  
Engine Coolant Temperature [47](#)  
Engine Cooling Recommendations and Specifications [225](#)  
Engine Fan [245](#)  
Engine Fan Override [89](#)  
Engine is overheating [31](#)  
Engine Maintenance [241](#)  
Engine Mounting [249](#)  
Engine Oil Pressure [47](#)  
Engine Warm Up [119](#)  
Engine, Brake Level [58](#), [89](#)  
Engine, Brake ON/OFF [58](#)  
Engine, Check Engine [59](#)  
Engine, Cruise Control On/Off [89](#)  
Engine, Engine Block Heater [59](#)  
Engine, Low Coolant Level [59](#)  
Engine, Overspeed [59](#)  
Engine, Retarder (Brake) [59](#)  
Engine, Shutdown [90](#)  
Engine, Stop Engine [59](#)  
Engine, Wait To Start [60](#)  
Every 120,000 miles /193,000 km / 2 yr Preventative Maintenance Intervals: [196](#)  
Exhaust [123](#)  
Exhaust Brake [145](#)  
Exhaust System [248](#)  
Exterior Lights Self-Test [103](#)  
Exterior Lights Switch [66](#)

## F

Fifth Wheel [156–158](#)  
Fifth Wheel Bi-Annual Maintenance [251](#)

Fifth Wheel Locked IndicatorFifth Wheel [60](#)  
Fifth Wheel Lubrication [161](#)  
Fifth Wheel Monthly Maintenance [251](#)  
Fifth Wheel Slide, *See* How to Slide the Fifth Wheel  
Fifth Wheel Slide Switch [91](#)  
Fifth Wheel Slide Unlocked [61](#)  
Fifth Wheel Unlocked IndicatorFifth Wheel [61](#)  
Final Chassis Bill of Material [12](#)  
Final Stopping Procedures [164](#)  
Flashing Headlamps, Aftertreatment Warning [123](#)  
Flex Air Fastener Torque ValueRear Suspension Fasteners [286](#)  
Frame [250](#)  
Frame Fastener Torque Requirements [280](#)  
Front axle and Suspension [252](#)  
Front Brake System [136](#)  
Front Suspension U-Bolts, Grade 8 [282](#)  
Fuel System [249](#)  
Fuel Tank [250](#)  
Fuller Transmission Lubrication [199](#)  
FuseInspect and replace [32](#)  
FuseLocation [34](#)  
Fuses, Circuit Breakers and Relays [234](#)

## G

Gauge Views [71](#)  
Gauges  
    Digital [48](#)  
    Optional [48](#)  
General Safety Instructions [8](#)  
Glove Box [113](#)  
Greenhouse Gas Certified Configuration [293](#)  
Greenhouse Gas Certified Tires [269](#)

## H

Hand Brake, *See* Parking Brake  
Headlight [230](#)

Headlight Adjustment [230](#)  
Headlight Performance [230](#)  
Headlights, *See* Exterior Lights Switch  
Heater and Air Conditioner Maintenance [255](#)  
Heating and Air Conditioning [104](#)  
High Beam [97](#)  
High Beam Flash [98](#)  
Hill Hold [61](#)  
Horn [100](#)  
Horn honking, Aftertreatment Warning [123](#)  
How to Add Coolant to the Cooling System [228](#)  
How to Adjust Mirrors [101](#)  
How to Check the Compressed Air System for Leaks [210](#)  
How to Enter the Passcode [68](#)  
How to Open the Hood [15](#)  
How to Prepare the Axles for Towing [39](#)  
How to Recover a Vehicle Towing [36](#)  
How to Replace a Headlight Bulb [231](#)  
How to Start the PTO -(within PTO Operations) [121](#)  
How to Wash the Exterior of the Vehicle [220](#)  
HVAC [104](#)  
HVAC Air Filter [222](#)  
Hydraulic Brake System [214](#)  
Hydraulic Brakes [133](#)  
Hydraulic Clutch [273](#)

## I

Ice [42](#)  
Ignition Key Switch [103](#)  
Illustrations [7](#)  
In Cab Battery Access [238](#)  
Initial Charge [138](#)  
Inside/Outside Engine Air Intake [119](#)  
Inspect Power Steering Fluid [203](#)  
Inspecting Noise and Emission Components [258](#)  
Install Engine Belt [244](#)  
Installing Batteries [239](#)  
Instrument Panel [46](#)  
Instrument Panel Brightness, *See* Cab and Panel Dimmer Switch

Inter-Axle Differential Lock Operation [148](#)  
Interior Storage, *See* Glove Box  
Introduction [102](#)

## J

Jump Starting [34](#)

## K

Kenworth T440, T470 [144](#)  
Key Fob [240](#)  
Keyless Entry [240](#)  
Kingpin Release Switch [91](#)

## L

Lamps, Headlamps Flashing, Aftertreatment Warning [123](#)  
Lane Departure Mute [92](#)  
Lane Departure Warning (LDW) [61](#)  
Left Switch Pod [64](#)  
Light [230](#)  
Light Self Test, *See* Exterior Lights Self-Test  
Lighter, *See* Cigarette Lighter and Ashtray  
Lights, Flood ISO 3732 Spare [92](#)  
Lights, High Beam [61](#)  
Lights, Map, *See* Lights, Dome  
Locking the Fifth Wheel, *See* How to Lock the Kingpin  
Low Air Alarm [29](#)  
Low Air Leaf Fastener Torque Value Rear Suspension Fasteners [286](#)  
Low Oil Pressure Lamp [30](#)  
Lubricants [197](#)  
Lubrication Specification Chart [276](#)  
LVD, *See* Low Voltage Disconnect

## M

Main transmission [198](#)  
Maintenance Manuals [12](#)  
Malfunction Indicator Lamp (MIL) [62](#)  
Manual Kingpin Release/Fifth Wheel Operation [158](#)  
Manually lock a differential [40](#)  
Marker lights, *See* Exterior Lights Switch  
Maximum Number of Lamps Allowed per Circuit [234](#)  
MCS, *See* Menu Control Switch  
Menu [74](#)  
Menu Control Switch [63](#)  
Meritor Axle Lubrication [201](#)  
Message Waiting [62](#)  
Mirror Controls [101](#)  
Mirror switch [101](#)  
Mud [42](#)

## N

New Vehicle Maintenance Schedule [171](#)  
New Vehicle Maintenance Schedule: First 2,000 mi / 3,218 km [172](#)  
New Vehicle Maintenance Schedule: First 50-100 mi / 80-160 km [171](#)  
New Vehicle Maintenance Schedule: First 500 mi / 800 km [172](#)  
New Vehicle Maintenance Schedule: First Day [171](#)  
New Vehicle Maintenance Schedule: First 3,000-5,000 mi / 4800-8000 km [172](#)  
Noise and Emission Control [257](#)  
Noise Control System - Maintenance Log [281](#)  
Normal Run Position [138](#)

## O

Oil Changes [198](#)  
Oil Level [198](#)  
Oil-lubricated Driven Hubs [203](#)  
Oil-lubricated Nondriven Hubs [203](#)  
Operate Door Locks using Remote Keyless Entry [14](#)  
Operation [88](#)

Operational checks of automatic slack adjusters [213](#)  
Overflow tank [227](#)  
Overheated Brakes [144](#)

## P

PACCAR 20k Front Axle Lubrication [254](#)  
PACCAR 8 Speed Recommended Lubricants [200](#)  
PACCAR Shifter [96](#)  
Park Brake [62](#)  
Parking Brake [134](#)  
Parking Brake Burnishing [134](#)  
Parking Brake Component Inspection [217](#)  
Parking lights, *See* Exterior Lights Switch  
Pipe and Hose Clamp Torque Values [243](#), [274](#)  
Popup [69](#)  
Post Trip [77](#)  
Power Steering Fluid [265](#)  
Pre-Cleaner [247](#)  
Prepare the Axles for Towing [39](#)  
Preventative Maintenance Intervals: Every 50 Hours [177](#)  
Preventative Maintenance Intervals: Every 60,000 mi / 96,000 km / 6 mo [194](#)  
Preventative Maintenance Intervals [173](#)  
Preventative Maintenance Intervals: Every 750 mi / 1,207 km / 1 mo [177](#)  
Preventative Maintenance Intervals: Every 15,000 mi / 24,000 km / 12 mo [184](#)  
Preventative Maintenance Intervals: Every 60,000 mi / 96,000 km [195](#)  
Preventative Maintenance Intervals: Every 7,500 mi / 12,000 km / 6 mo [178](#)  
Program Key Fobs [241](#)  
PTO Mode [74](#)  
PTO Operations [121](#)  
PTO Operations How to Stop the PTO [122](#)  
Purpose [88](#)

## R

Radiator Hoses [228](#)  
Radio, *See* Stereo Radio  
Rear Axle Alignment [263](#)  
Rear Axle and Suspension [260](#)

Rear Axle Lubrication [262](#)  
Rear Brake System [136](#)  
Rear Suspension Fasteners/18K Air Leaf Suspension [287](#)  
Rear Suspension U-Bolts, Grade 8 [282](#)  
Rear Suspension/13.5K Taper Leaf Fastener Torque Values [287](#)  
Reclining Seats [18](#)  
Recommended Fuller Lubricants [199](#)  
Recovery hitch/Best practices [41](#)  
Recovery hitch/Prepare axles [39](#)  
Refilling [199](#)  
Release Kingpin/Fifth Wheel Operation [158](#)  
Releasing the Kingpin, See How to Release the Kingpin from the Cab  
Remote Keyless Entry [240](#)  
Removing Batteries [238](#)  
Repairs [11](#)  
Replace Battery Box Cover [239](#)  
Replace HVAC Air Filter [222](#)  
Replace the Recirculation Air Filter [257](#)  
Replacing the Primary Fuel Filter [249](#)  
Returning to Service after Recovering [42](#)  
Right Switch Pod [64](#)  
Roadside Assistance [29](#)

## S

Safety [6, 12](#)  
Safety Alerts [6](#)  
Safety Restraint System - Inspection [223](#)  
Sand [42](#)  
Scroll Wheel [65](#)  
Seat  
    Komfort Latch [22](#)  
    Lap/Shoulder Belt [20](#)  
    Safety Restraint Belts [18](#)  
    Tether Belts [21](#)  
Seat Adjustment [17](#)  
Seat Belt, Fasten [62](#)  
Service Brake Component Inspection [216](#)  
Settings [76](#)  
Sliding Fifth Wheels [252](#)

Sliding the Fifth Wheel, See How to Slide the Fifth Wheel  
Slow Battery Charging [239](#)  
Snow [42](#)  
Speedometer [47](#)  
Stability Control [56, 57](#)  
Standard Driver's Seat [17](#)  
Steerable Drive Axle [133](#)  
Steering Shaft Bolt Torque Specifications [265](#)  
Steering System [264](#)  
Steering Wheel Controls (option) [63](#)  
Stereo Radio [111](#)  
Stop Engine Light [30](#)  
Stop/Turn Signal Lamp Operation [96](#)  
Stopping Procedures [164](#)  
Surge tank [227](#)  
Suspension U-Bolts [282](#)  
Suspension, Air Retention [94](#)  
Suspension, Axle, Pusher [94](#)  
Suspension, Axle, Tag [94](#)  
Suspension, Lift [94](#)  
System Park [139](#)  
Systems Check [26](#)

## T

Tachometer [48](#)  
Telltails [48](#)  
Test the Exterior Lights [104](#)  
Testing Exterior Lights, See Exterior Lights Self-Test  
Tilt Telescope [96](#)  
Tire Inflation [266](#)  
Tire Pressure Monitoring System [73](#)  
Tires [266](#)  
To LOCK the Inter-Axle Differential [148](#)  
To Release the Full Combination of Brakes [137](#)  
To Release the Trailer Brakes ONLY [137](#)  
To Release the Vehicle Parking Brakes ONLY [137](#)  
To UNLOCK the Inter-Axle Differential [148](#)  
Topping Up the Engine Oil [243](#)  
Towing the Vehicle [43](#)

# Index

---

Trailer Brake Hand Valve [139](#)  
Trailer Charge [139](#)  
Trailer Dump Gate [95](#)  
Trailer Hand Brake [88](#)  
Trailer Park or Emergency Brake Application Only [139](#)  
Trailer, Axle Lift Forward [95](#)  
Trailer, Axle Lift Rear [95](#)  
Transmission Gear Display [129](#)  
Transmission Oil Temperature Gauge [129](#)  
Transmission, Automated [132](#)  
Transmission, Oil Temperature High [62](#)  
Transmission Maintenance [273](#)  
Trip Info [73](#)  
Trip Information, See Trip Info  
Truck Info [76](#)  
Truck Information, See Truck Info  
Turbocharger [246](#)  
Turn Signal [96, 97](#)  
Turn Signal, Left [62](#)  
Turn Signal, Right [63](#)

## U

Under Cab Battery Access [238](#)  
Under hood air filter housing [246](#)  
Under Hood Air Intake Symbol [119](#)  
Under Hood Intake [119](#)  
Unlock Fifth Wheel, See How to Release the Kingpin from the Cab  
Unlocking the Fifth Wheel/Fifth Wheel Operation [158](#)  
USB Charger, See Dual USB Charger  
Using the Parking Brake [136](#)  
Using the Telematic System [114](#)

## V

Vehicle Emissions Limited Express Warranty [296](#)  
Vehicle ID Labels [289](#)  
Vehicle is stuck [42](#)  
Vehicle Light Bulb specifications [283](#)

Vehicle Loading [22](#)  
Vehicle Telematic System [113](#)  
Vehicle/Trailer Air Supply Valve [138](#)  
Views [70](#)  
Visual inspection while approaching the vehicle [23](#)

## W

Warm Up, Engine [119](#)  
Warning Lights and Indicators [48](#)  
Weekly Checks [25](#)  
Welcome Screen [67](#)  
Wet Brakes [143](#)  
What is an Air Compressor [210](#)  
What is the Air System [204](#)  
Wheel Bearing Lubrication [203](#)  
Wheel Cap Nut Torque Specifications [275](#)  
Wheels [269](#)  
Windshield Washer [99](#)  
Windshield Wiper [98](#)  
Windshield Wiper/Washer [229](#)  
Worn brake [63](#)



# PETERBILT MOTORS COMPANY

A PACCAR Company  
P.O. Box 90208  
Denton, Texas 76202

Do not remove the manual from vehicle.  
Before operating vehicle study the manual carefully.  
Read and understand all warnings, cautions and notes.

Need help? Give us a call 24 hours a day  
**1.800.4.PETERBILT**



SCAN THIS QR CODE  
TO ACCESS ONLINE  
DRIVER RESOURCES.  
[peterbilt.com/driver-resources](http://peterbilt.com/driver-resources)



Y53-6113-1A1

Printed in the U.S.A. 11/20