

MODEL 365

MODEL 367

MODEL 389



Safety

1

Emergency

2

Controls

3

Driving

4

Maintenance

5

Information

6

© 2021 PACCAR Inc. - All Rights Reserved

This manual illustrates and describes the operation of features or equipment which may be either standard or optional on this vehicle. This manual may also include a description of features and equipment which are no longer available or were not ordered on this vehicle. Please disregard any illustrations or descriptions relating to features or equipment which are not on this vehicle. PACCAR reserves the right to discontinue, change specifications, or change the design of its vehicles at any time without notice and without incurring any obligation. The information contained in this manual is proprietary to PACCAR. Reproduction, in whole or in part, by any means is strictly prohibited without prior written authorization from PACCAR Inc.

Chapter 1 | SAFETY

Using this Manual.....	7
Safety Alerts.....	7
Illustrations.....	8
General Safety Instructions.....	8
Data Recorder.....	11
Environmental Protection Agency.....	11
Repairs.....	12
Additional Sources of Information.....	13
Cab Access.....	13
Climbing onto the Deck Plate.....	15
How to open the hood.....	17
Close the Hood.....	18
Standard Seat.....	19
Safety Restraint Belts.....	19
Sleeper Bunks and Restraints.....	24

What to do before starting the vehicle.....	25
Vehicle Loading.....	26
Visual inspection while approaching the vehicle.....	27
Daily Checks.....	28
Weekly Checks.....	29
Systems Check.....	30

Using this Manual

Please take the time to get acquainted with your vehicle by reading this Operator's Manual. We recommend that you read and understand this manual from beginning to end before you operate this equipment. This manual contains useful information for the safe and efficient operation of this equipment. It also provides service information, with an outline for performing safety checks and basic preventive maintenance inspections. We have tried to present the information you'll need to learn about functions, controls, and operation—and to present it as clearly as possible. We hope you'll find this manual easy to use. There will be times when you need to take this manual out of the glovebox. When you do, please be sure to return it when you are finished using it.

	NOTE
<p>After you've read this manual, it should be stored in the cab for convenient reference and remain with this truck when sold.</p>	

Your vehicle may not have all the features or options mentioned in this manual. Therefore, you should pay careful attention to the instructions that pertain to just your vehicle. In addition, if your vehicle is equipped with special equipment or options not discussed in this manual, consult your dealer or the manufacturer of the equipment.

There are several tools built into this manual to help you find what you need quickly and easily; first is the Quick Table of Contents. Located at the front of the manual, this table lists the main subjects covered and gives section numbers where you can find these subjects. Use the Quick Table of Contents to find information on a large subject and then use the detailed table of contents found on the first page of each chapter. Cross-referenced citations also help you get the information you need. If some other part of the manual contains further information on the subject you are reading about, we'll indicate that in a cross-reference like this: (See [Safety Alerts](#) on page 7).

Finally, you'll find a helpful Subject Index. It's in the back of the manual and alphabetically lists the subjects covered. All information contained in this manual is based on the latest production information

available at the time of publication. Peterbilt Motors Company reserves the right to make changes at any time without notice.

Safety Alerts

Read and follow all of the safety alerts contained in this manual. They are there for your protection and information. These alerts can help you avoid injury to yourself, your passengers, and help prevent costly damage to the vehicle. Safety alerts are highlighted by safety alert symbols and signal words such as "WARNING," "CAUTION," or "NOTE." DO NOT ignore any of these alerts.

Warnings



The safety message following this symbol and signal word provides a warning against operating procedures which could cause death or injury. They could also cause equipment or property damage. The alert will identify the hazard, how to avoid it, and

the probable consequence of not avoiding the hazard.

Example:



WARNING

Hot engine oil can be dangerous. You could be burned. Let the engine oil cool down before changing it. Failure to comply may result in death, personal injury, equipment or property damage.

Cautions



The safety message following this symbol and signal word provides a caution against operating procedures which could cause equipment or property damage. The alert will identify the hazard, how to avoid it, and the probable consequence of not avoiding the hazard.

Example:



CAUTION

Continuing to operate your vehicle with insufficient oil pressure will cause serious engine damage. Failure to comply may result in equipment or property damage.

Notes



The message following this symbol and signal word provides important information that is not safety related but should be followed. The alert will highlight things that may not be obvious and is useful to your efficient operation of the vehicle.

Example:



NOTE

Pumping the accelerator will not assist in starting the engine.

Illustrations

Some of the illustrations throughout this manual are generic and will not look exactly like the engine or parts used in your application. The illustrations can contain symbols to indicate an action required and/or an acceptable or unacceptable condition.

The illustrations are intended to show repair or replacement procedures. The procedure will be the same for all applications, although the illustrations may differ.

General Safety Instructions



WARNING

Improper practices, carelessness, or ignoring any warnings may cause property damage, personal injury, or death.

 **WARNING**

Manually rotating the crankshaft requires a trained technician and specialty tools. DO NOT pull or pry on the fan in an attempt to rotate the crankshaft. Applying force to the fan can damage the fan blades or cause premature fan failure. Failure to comply with the approved procedure may result in property damage, personal injury, or death.

Before performing any repair, read and understand all of the safety precautions and warnings. The following is a list of general safety precautions that must be followed to provide personal safety. Failure to follow these instructions may cause death or injury. Special safety precautions are included in the procedures when they apply.

Keep in mind that even a well maintained vehicle must be operated within the range of its mechanical capabilities and the limits of its load ratings. See the Weight Ratings label on the driver's door edge. Every new vehicle is designed to conform to all Federal Motor Vehicle Safety Standards applicable at the time of manufacture. Even with these safety

features, continued safe and reliable operation depends greatly upon regular vehicle maintenance. Follow the maintenance recommendations found in Preventive Maintenance section. This will help preserve your investment.

Make sure your vehicle is in top working condition before heading out on the road, it is the responsible driver's duty to do so. Inspect the vehicle according to the Driver's Check List.

- Work areas should be dry, well lit, well ventilated, free from clutter, loose tools, parts, ignition sources and hazardous substances.
- Wear protective glasses and protective shoes when working.
- DO NOT wear loose-fitting or torn clothing. Tie back and/or tuck in long hair. Remove all jewelry when working.
- Before beginning any repair, disconnect the battery (negative [-] cable) and discharge any capacitors.
- Put a "DO NOT OPERATE" tag in the operator's compartment or on the controls.
- Allow the engine to cool before slowly loosening the coolant fill cap

 **WARNING**

Removing the fill cap on a hot engine can cause scalding coolant to spray out and burn you badly. If the engine has been in operation within the previous 30 minutes, be very careful in removing the fill cap. Protect face, hands, and arms against escaping fluid and steam by covering the cap with a large, thick rag. DO NOT try to remove it until the surge tank cools down or if you see any steam or coolant escaping. Always remove the cap very slowly and carefully. Be ready to back off if any steam or coolant begins to escape.

- Always use wheel chocks or proper jack stands to support the vehicle or vehicle components before performing any service work. DO NOT work on anything that is supported only by lifting jacks or a hoist. Before resting a vehicle on jack stands, be sure the stands are rated for the load you will be placing on them.

- Before removing or disconnecting any lines, fittings, or related items, relieve all pressure in the air, oil, fuel, and cooling systems. Remain alert for possible pressure when disconnecting any device from a system that contains pressure. High pressure oil or fuel can cause death or personal injury.
- Always wear protective clothing when working on any refrigerant lines and make sure that the workplace is well ventilated. Inhalation of fumes can cause death or personal injury. To protect the environment, liquid refrigerant systems must be properly emptied and filled using equipment that prevents the release of refrigerant gas. Federal law requires capturing and recycling refrigerant.
- When moving or lifting any heavy equipment or parts, make sure to use proper techniques and assistance. Ensure all lifting devices such as chains, hooks, or slings are in good condition and are of the correct load capacity. Make sure all lifting devices are positioned correctly.
- Corrosion inhibitors and lubricating oils may contain alkali. DO NOT get the substance in eyes and avoid prolonged or repeated contact with skin. DO NOT swallow. If ingested, seek immediate medical attention. DO NOT induce vomiting. In case of contact, immediately wash skin with soap and water. In case of harmful contact, immediately contact a physician. Always keep any chemicals OUT OF REACH OF CHILDREN.
- Naphtha and Methyl Ethyl Ketone (MEK) are flammable materials and must be used with caution. Follow the manufacturer's instructions to ensure safety when using these materials. Always keep any chemicals OUT OF REACH OF CHILDREN.
- When working on the vehicle, be alert for hot parts on systems that have just been turned off, exhaust gas flow, and hot fluids in lines, tubes, and compartments. Contact with any hot surface may cause burns.
- Always use tools that are in good condition. Make sure you have the proper understanding of how to use the tools before performing any service work. Use only genuine replacement parts from PACCAR.
- Always use the same fastener part number (or equivalent) when replacing items. DO NOT use a fastener of lesser quality if replacements are necessary. (e.g., DO NOT replace a SAE 10.9 grade with 8.8 grade fastener.)
- Always torque fasteners and fuel connections to the required specifications. Overtightening or under-tightening can allow leakage.
- Close the manual fuel valves prior to performing maintenance and repairs, and when storing the vehicle inside.
- DO NOT perform any repair when impaired, tired, fatigued, or after consuming alcohol or drugs that can impair your functioning.
- Some state and federal agencies in the United States of America have determined that used engine oil can be carcinogenic and can cause reproductive toxicity. Avoid inhalation of vapors, ingestion, and

prolonged contact with used engine oil.

- DO NOT connect the jump starting or battery charging cables to any ignition or governor control wiring. This can cause electrical damage to the ignition or governor.
- Coolant is toxic. If not reused, dispose of coolant in accordance with local environmental regulations.



CAUTION

Corrosive chemicals can damage the engine. DO NOT use corrosive chemicals on the engine. Failure to comply may result in equipment or property damage.

California Proposition 65 Warning

- Diesel engine exhaust and some of its constituents are known to the State of California to cause cancer, birth defects, and other reproductive harm.
- The catalyst substrate located in the Diesel Particulate Filter (DPF) contains vanadium pentoxide,

which has been determined by the State of California to cause cancer. Always wear protective clothing and eye protection when handling the catalyst assembly. Dispose of the catalyst in accordance with local regulations. If catalyst material gets into the eyes, immediately flood eyes with water for a minimum of 15 minutes. Avoid prolonged contact with skin. In case of contact, immediately wash skin with soap and water. In case of harmful contact, immediately contact a physician.

- Other chemicals in this vehicle are also known to the State of California to cause cancer, birth defects or other reproductive harm.
- Battery posts, terminals, and related accessories contain lead and lead compounds, chemicals known to the State of California to cause cancer and reproductive harm. Wash hands after handling.

Data Recorder

California Vehicle Code - Section 9951 - Disclosure of Recording Device

Your vehicle may be equipped with one or more recording devices commonly referred to as "event data recorders" (EDR) or "sensing and diagnostic modules" (SDM). If you are involved in an accident, the device(s) may have the ability to record vehicle data that occurred just prior to and/or during the accident. For additional information on your rights associated with the use of this data, contact:

- The California Department of Motor Vehicles - Licensing Operations Division
- <http://www.dmv.ca.gov/>

Environmental Protection Agency

Some of the ingredients in engine oil, hydraulic oil, transmission and axle oil, engine coolant, diesel fuel, air conditioning refrigerant (R12, R134a, and PAG oil), batteries, etc., may contaminate the

environment if spilled or not disposed of properly.

**WARNING**

Diesel engine exhaust and some of its constituents are known to the State of California to cause cancer, birth defects, and other reproductive harm. Other chemicals in this vehicle are also known to the State of California to cause cancer, birth defects or other reproductive harm. This warning requirement is mandated by California law (Proposition 65) and does not result from any change in the manner in which vehicles are manufactured.

Contact your local government agency for information concerning proper disposal.

Repairs**WARNING**

DO NOT attempt repair work without sufficient training, service manuals, and the proper tools. You could be kil-

led or injured, or you could make your vehicle unsafe. Perform only those tasks you are fully qualified to do.

**WARNING**

Modifying your vehicle can make it unsafe. Some modifications can affect your vehicle's electrical system, stability, or other important functions. Before modifying your vehicle, check with your dealer to make sure it can be done safely. Improper modifications can cause death or personal injury.

**CAUTION**

The installation of electronic devices to the On Board Diagnostics (OBD) connector, the vehicle Controller Area Network (CAN), or their associated wiring is not permitted. Doing so can adversely affect vehicle performance and/or cause fault codes to be recorded. The OBD connector is provided for temporary connection of service tools and for diagnostic purposes only.

Your dealer's service center is the best place to have your vehicle repaired. You can find dealers all over the country with the equipment and trained personnel to get you back on the road quickly—and keep you there.

Your vehicle is a complex machine. Anyone attempting repairs on it needs good mechanical training and the proper tools. However, all warranty repairs must be performed by an authorized service facility. If you aren't an experienced mechanic, or don't have the right equipment, please leave all repairs to an authorized service facility. They are the ones best equipped to do the job safely and correctly.

Maintenance Manuals

If you do decide to do any complex repair work, you'll need the maintenance manuals. Order them from your authorized dealer. Please provide your Chassis Serial Number when you order, to be sure you get the correct manuals for your vehicle. Allow about four weeks for delivery. There will be a charge for these manuals.

Final Chassis Bill of Material

A complete, non-illustrated computer printout listing of the parts used to custom-build your vehicle is available through the dealer from whom you purchased your vehicle.

Additional Sources of Information

Major component suppliers also supply operation manuals specific to their products. Additional manuals and other pieces of literature are included in the glove box literature package. Look for information on products such as the engine, driver's seat, transmission, axles, wheels, tires, ABS/ESC, radio, fifth wheel, lane departure, and adaptive cruise control. If you are missing these pieces of literature, ask your dealer for copies. Another place to learn more about trucking is from local truck driving schools. Contact one near you to learn about courses they offer. Federal and state agencies such as the department of licensing also have information. The Interstate Commerce Commission can give you information

about regulations governing transportation across state lines.

Cab Access



WARNING

Always reinstall steps before entering the cab or accessing the deck plate. Without steps you could slip and fall. Failure to comply may result in personal injury or death.



WARNING

Keep steps clean. Clean any fuel, oil, or grease off the steps before entering the cab or accessing the deck plate. Stepping on a slippery surface can cause a fall which may result in death or personal injury.

Be careful whenever you get into or out of your vehicle's cab. Always maintain at least three points of contact with your hands on the grab handles and your feet on the steps. The following picture shows

the best way to enter and exit a Conventional Cab.



WARNING

Jumping out of the cab or getting into the cab without proper care is dangerous. You could slip and fall, which could lead to death or personal injury. Keep steps clean. Clean any fuel, oil, or grease off of the steps before entering the cab. Use the steps and grab handles provided, and always keep at least three points of contact between your hands and feet and the truck. Look where you are going.



How to Lock and Unlock the Cab Doors

The vehicle has one key for cab doors, ignition, and the optional sleeper luggage compartment. Frame-mounted tool box locks and locking fuel tank caps each have separate, individual keys.



WARNING

To help lessen the chance and/or severity of death or personal injury in case of an accident, always lock the doors while driving. Along with using the lap shoulder belts properly, locking the doors helps prevent doors from inadvertently opening and occupants from being ejected from the vehicle.

To lock or unlock the doors from outside the cab:

1. Insert the key into the lock.
 - Rotate the key toward the rear of the vehicle to lock (clockwise), or
 - Rotate the key toward the front of the vehicle (counter clockwise) to unlock.

Remote Keyless Entry (Option)

Remote Keyless Entry (RKE) is a system that adds security and convenience to your vehicle. The system will lock or unlock cab doors with the key fob. The system will alert you with parking lights when the selected doors are locked or unlocked. The

system includes two key fobs that provide secure rolling code technology that prevents someone from recording the entry signal.



NOTE

FCC ID: L2C0031T IC: 3432A-0031T
 FCC ID: L2C0032R IC: 3432A-0032R
 This device complies with Part 15 of the FCC Rules and with RSS-210 of Industry Canada. Operation is subject to the following two conditions (1) This device may not cause harmful interference, and (2) This device must accept any interference received, including interference that may cause undesired operation. Changes or modifications not expressly approved by the party responsible for compliance could void the user's authority to operate the equipment. The term IC: before the radio certification number only signifies that Industry Canada technical specifications were met.

Operate Door Locks using Remote Keyless Entry

Open doors will not lock using the key fob. The key fob should be within 30 ft. (9 m) of the vehicle and should not be in proximity of other RF sources such as television, radio or cell phone transmitters.

To unlock the cab doors:

1. Press the **UNLOCK** button once. The driver's door will unlock and the parking lights will come on for 40 seconds.
2. Quickly press the **UNLOCK** button a second time within 5 seconds to unlock the passenger door.
3. Press the **LOCK** button. The doors will lock and the parking lights will come on for 2 seconds.

Climbing onto the Deck Plate



WARNING

Always reinstall steps before entering the cab or accessing the deck plate. Without steps you could slip and fall.

Failure to comply may result in personal injury or death.



WARNING

Keep steps clean. Clean any fuel, oil, or grease off the steps before entering the cab or accessing the deck plate. Stepping on a slippery surface can cause a fall which may result in death or personal injury.



WARNING

When you are climbing onto and off the deck plate, maintain at least three points of contact with your hands on the grab handles and your feet on the steps. Always face toward the vehicle when entering or exiting the cab and look where you are going. Failure to comply may result in death or personal injury.



WARNING

When stepping onto a surface to enter the cab or access the deck plate, only use the steps and grab handles installed and designed for that purpose. Failure to use the proper steps and grab handles could cause a fall which may result in death or personal injury.



NOTE

Any alteration (adding bulkheads, headache racks, tool boxes, etc.) behind the cab that affects the utilization of installed grab handles, deck plates, or frame access steps should comply with Federal Motor Carrier Safety Regulation 399.

The following pictures show you the right way to get on and off the area behind your cab.

1

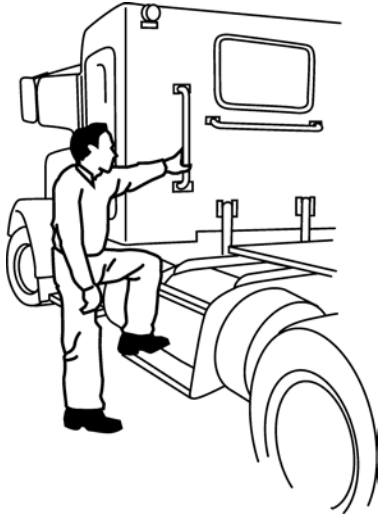

Hold handles as you step up.

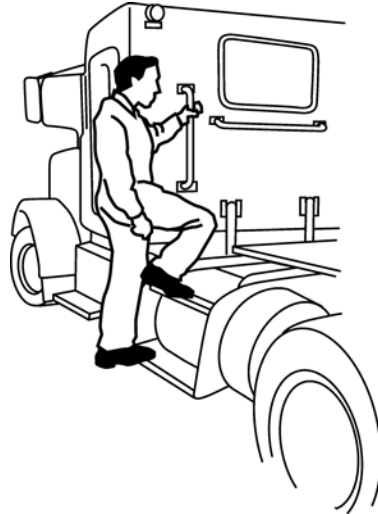

Maintain three points of contact.

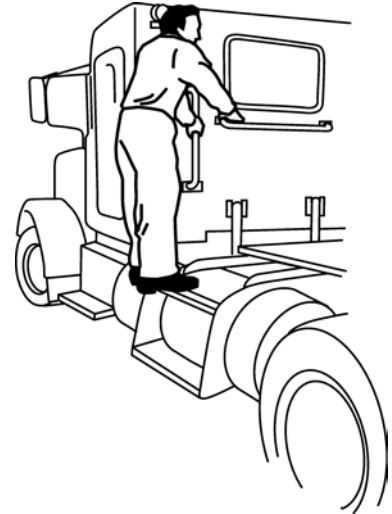

Maintain three points of contact as you reach the deck area.

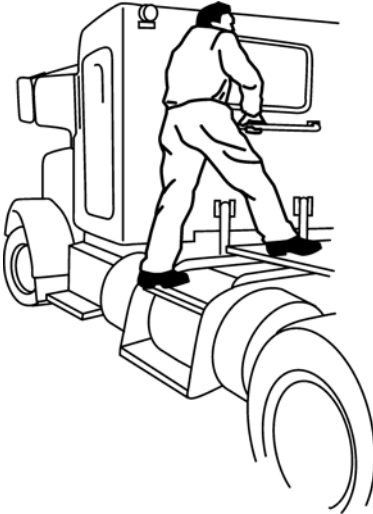

Maintain three points of contact as you step to deck plate.

How to open the hood

Access the engine by opening the hood. The hood is typically held in the closed position by a latch system. The latches are typically mounted on the hood and the

mating side is on the cab or quarter fenders.

WARNING

Before opening or closing the hood, make sure your footing is secure and stable. Failure to do so may cause the hood to open or close uncontrollably which may result in death or personal injury.

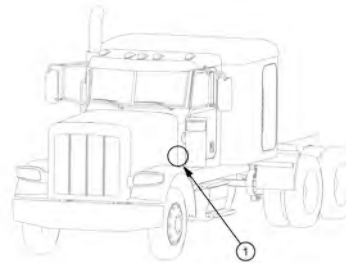

1. Hood hold down

CAUTION

A hood not latched securely could open during operation and cause vehicle damage. Be sure to latch the hood securely.

WARNING

A pivoting hood could hurt someone or be damaged itself. Before opening or closing the hood, be sure there are no people or objects in the way. Failure to stand in a position of safety can cause death or personal injury.

1. Release the latches

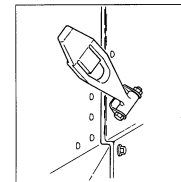

Latched

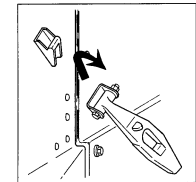

Unlatched

2. Place one hand on the hood emblem, one foot on the bumper, one foot on the ground, and tilt the

1

hood forward. Keep pulling on the hood until you are certain that the hood hold open device is engaged.



To disengage the latch for hood closure, rotate the release lever fully forward.

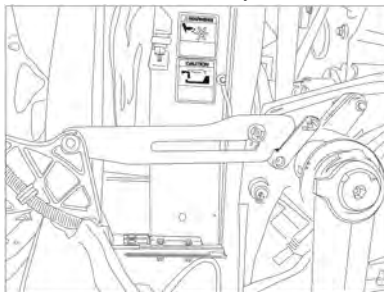

Press in to disengage.



When closing the hood, be sure that you maintain the same point of contact (top of hood) to control the movement of the hood as it closes. Gently lower the hood into place to avoid damage to the hood or cab.

Close the Hood

The hood is equipped with a hood hold-open device. In order for the hood hold-open device to become engaged, the vehicle hood must be fully open. Once the vehicle hood is fully open, the hold-open latch will automatically engage and will need to be disengaged by the operator.



WARNING

DO NOT let go of the hood while it closes. Close the hood in a controlled manner which requires hands firmly grasping the hood and feet on a stable, non-slip, surface. Failure to control the hood as it closes may result in death or personal injury



WARNING

Always ensure the hood hold open latch is engaged to keep the hood fully open any time anyone gets under the hood for any reason. Failure to do so may cause the hood to close uncontrollably which may result in death or personal injury.



WARNING

Before closing the hood, be sure the area is clear—no people or objects are in the way. Failure to do so may result in death or personal injury.

Standard Seat



WARNING

DO NOT adjust the driver's seat while the vehicle is moving. The seat could move suddenly and unexpectedly and can cause the driver to lose control of the vehicle. Make all adjustments to the seat while the vehicle is stopped. After adjusting the seat and before driving off, always check to ensure that the seat is firmly latched in position. Failure to comply may result in property damage, personal injury, or death.

The standard driver's seat can be adjusted forward and rearward. These movements are each controlled by levers located on the FRONT of the seat.

Seat with Air Suspension

The driver's seat with air suspension can be adjusted on the side of the seat for seat height and backrest incline. The front of the seat has controls to move the seat fore and aft.



WARNING

Before driving or riding in vehicle, ensure that there is adequate head clearance at maximum upward travel of seat. Injury may occur if head clearance is not adequate. Failure to comply may result in personal injury or death.

Safety Restraint Belts

Safety belts have proven to be the single most effective means available for reducing the potential for either death or personal injury in motor vehicle accidents. The combination lap/shoulder belt is equipped with a locking mechanism. The system adjusts automatically to a person's size and movements as long as the pull on the belt is slow. Hard braking or a collision locks the belt. The belt will also lock when driving up or down a steep hill or in a sharp curve.

Unbelted riders could be thrown into the windshield or other parts of the cab or could be thrown out of the cab. They could

strike another person. Injuries can be much worse when riders are unbelted. Always observe user warnings pertaining to safety belts. Your vehicle is equipped with a seat belt indicator lamp, located on the dash.



WARNING

DO NOT drive vehicle without your seat belt and your passengers' belts fastened. Riding without a safety belt properly fastened can lead to injury or death in an emergency.



WARNING

DO NOT use the swivel function while a passenger is in the seat and the vehicle is in motion. The seat belt will not provide proper protection if the passenger is not facing forward and the vehicle is in an accident. Failure to comply may result in death or personal injury.

1

Correct Use of Restraint

Correct Placement of Lap Belt

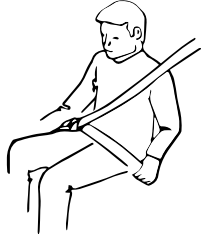

Correct Placement of Shoulder Belt



Incorrect Use of Restraint

Lap Belt Too High on the Hip

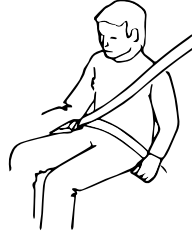

Shoulder Belt Incorrectly Under the Arm



Safety Restraint Belt Twisted



During Pregnancy

Pregnant women should always wear combination lap/shoulder belts. The lap belt portion must be worn snugly and as low as possible across the pelvis. To avoid pressure on the abdomen, the belt must never pass over the waist. A properly worn seat belt may significantly reduce the risks to woman and baby in the event of a crash.



Safety Restraint Tips

- DO NOT wear a belt over rigid or breakable objects in or on your clothing, such as eye glasses, pens, keys, etc., as these may cause injury in an accident.
- Any authorized person sleeping in your vehicle while it is moving should use the bunk restraint.
- Any authorized person sitting in the sleeper area on the sofa bed (if equipped) while it is moving should wear a seat belt.
- A responsible operator sees to it that everyone in the vehicle rides or sleeps safely. The operator is responsible to inform any passengers or co-drivers how to properly use the seat belts and bunk restraint in the vehicle.
- DO NOT strap in more than one person with each belt.
- Keep seat belt and bunk restraint buckles free of any obstruction that may prevent secure locking.
- Damaged or worn belts in the cab or sleeper subjected to excessive stretch forces from normal wear, must be replaced. They may not protect you if you are in an accident.
- Any belts or restraints that have been subjected to an accident should be inspected for any loose (attaching) hardware or damaged buckles.
- If belts show damage to any part of assembly, such as webbing, bindings, buckles or retractors, they must be replaced.
- DO NOT allow safety belts (seat or bunk) to become damaged by getting caught in door, bunk, or seat hardware, or rubbing against sharp objects.
- All belts must be kept clean or the retractors may not work properly.
- Never bleach or dye seat or bunk restraint belts: chemicals can weaken them. Do, however, keep them clean by following the care label on the belts. Let them dry completely before allowing them to retract or be stowed away.
- Make sure the seat belts and bunk restraint of the unoccupied passenger seat or bunk is fully wound up on its retractor or is stowed, so that the belt or restraint tongue is in its properly stowed position. This reduces the possibility of the tongue becoming a striking object in case of a sudden stop.
- DO NOT modify or disassemble the seat belts or bunk restraint in your vehicle. They will not be available to keep you and your passengers safe.
- If any seat belt or bunk restraint is not working properly, see an authorized dealer for repair or replacement.

How to Use Lap/Shoulder Belt

Follow these steps to fasten your seat belt and be sure anyone riding with you does the same.



WARNING

Proper seat belt adjustment and use is important to maximize occupant safety. Failure to wear or adjust the safety belt properly may result in death or personal injury.

To fasten the belt:

1. Grasp the belt tongue.
2. Pull belt in a continuous slow motion across your chest and lap.
3. Insert belt tongue into buckle on inboard side of seat.
4. Push down until the tongue is securely locked with an audible click.
5. Pull belt to check for proper fastening and adjustment.
 - a. Pull shoulder section to make sure belt fits snugly across the chest and pelvis.

- b. There should be less than one inch (25 mm) gap between the body and the belt.
- c. The shoulder belt must be positioned over the shoulder, it must never rest against the neck or be worn under the arm.
- d. Make sure any slack is wound up on the retractor and that the belt is not twisted.

If the belt is locked, lean the body back to remove any tension in the belt. After releasing the belt, allow the belt to retract completely by guiding the belt tongue until the belt comes to a stop.

To unfasten the belt, push the release button on the buckle and the belt should spring out of the buckle. The seat belt indicator will turn off once the driver's seat

belt is fastened.

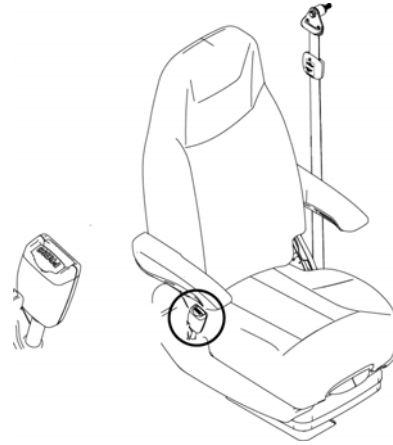

Tether Belts

Make sure that the tether belt is attached to the cab floor and seat frame. It should be routed through the buckle on each side. Often the attachments are made using a split-type hook. Make sure both halves of the hook are around the anchor bracket.

**WARNING**

DO NOT remove, modify, or replace the tether belt system with a different tether system. A failed or missing tether belt could allow the seat base to fully extend in the event of an accident. Failure to comply may result in death or personal injury.

**WARNING**

Failure to adjust external tether belts properly can cause excessive movement of the seat in an accident. Tether belts should be adjusted so that they are taut when the seat is in its most upward and forward position. Failure to comply may result in death or personal injury.

Adjust an external tether by either lengthening or shortening the strap. To lengthen it:

1. Turn the buckle to a right angle to the webbing.
2. Then pull the buckle.

3. To shorten the tether, pull on the strap.

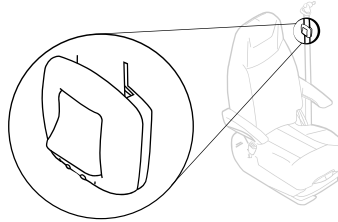
Komfort Latch Feature**WARNING**

DO NOT set the Komfort Latch with too much slack. Too much slack may reduce the effectiveness of the seat belt. Failure to comply may result in death or personal injury.

To eliminate cinching, simply activate the Komfort Latch device located on the seat belt webbing at the appropriate time:

1. Adjust the seat to its proper driving position.

2. Latch the seat belt.
3. If available, adjust the seat belt height adjuster to a comfortable driving position.
4. While seated appropriately, push the "on" button to engage the Komfort Latch.
5. Lean forward in the seat until you hear a "click."
6. Return to normal driving position, and the Komfort Latch maintains the preset amount of tension relief.

More information and video tutorials can be found at: <http://www.clicktugsnug.com/>
To disengage the mechanism unbuckle the seat belt and then press the **OFF** button of the Komfort Latch or tug on the shoulder strap.



Sleeper Bunks and Restraints

This vehicle comes equipped with a bunk restraint for the primary lower bunk and the optional upper bunk. These restraints should be used whenever the bunks are occupied by a person while the vehicle is in motion. The sleeper bunk restraint is intended to reduce the risk of being thrown from the bunk in a crash. This device is not designed to hold the occupant in a fixed position on the bunk and may not prevent all injuries in the event of a crash.



WARNING

Be sure the restraint system is used when anyone is occupying the sleeper while the vehicle is moving. In an accident, an unrestrained person lying in a sleeper bunk could be seriously injured. He or she could be thrown from the bunk. Failure to comply may result in death, personal injury, equipment or property damage.

Lower Bunk



WARNING

Always keep the lower bunk in its horizontal, latched, position while the vehicle is moving. If left open, stored items could become loose during an accident and strike you, causing death or personal injury.

Before you move the vehicle, check to be sure the lower bunk is in the down position.

Upper Bunk



WARNING

Be sure the latch that holds the upper bunk in the folded position is working properly so the bunk will not fall down. Pull on the bunk to be sure it is latched securely. If the bunk falls, you could be injured. Failure to comply may result in death, personal injury, equipment or property damage.



WARNING

Any loose items on the upper or lower bunk should be moved to a secured place before driving the vehicle. Failure to comply may result in death, personal injury, equipment or property damage.

Per FMCSR 392.60 - Unauthorized Persons Not to be Transported. Federal law prohibits the transportation of persons in commercial vehicles unless they are specifically authorized in writing by the motor carrier. See the cited FMCSR for a complete description of the regulation and exemptions.

Upper Rear Sleeper Storage

Your vehicle may be equipped with an upper storage shelf that extends over the lower bunk and across the rear of the sleeper. The following warning applies:

**WARNING**

Overhead compartments are not intended for personnel use or for items exceeding their designed weight limits. Exceeding the weight limits may cause the shelf to collapse and/or items may fall out in a sudden stop which may lead to death or personal injury.

Compartments in the cab and sleeper are provided for storage of necessary items used during operation. The storage areas above the door are designed to hold a combined total not exceeding 14 lbs (6 kg) per compartment and the other overhead compartments (including those in the optional sleeper) should hold a combined total not exceeding 5 lbs (2.2 kg) per compartment.

What to do before starting the vehicle

Safe Vehicle Operation

Be sure to perform pre-trip inspections before starting and operating the vehicle.

For your safety, as well as those around you, be a responsible driver:

- If you drink alcohol, do not drive.
- Do not drive if you are tired, ill, or under emotional stress.

Safe driving is only possible with the proper concentration on the driving task. Keep distraction to a minimum to improve your concentration. Examples of distractions may include radio controls, GPS navigation controls, cellular telephone calls, cellular text messages, reading or reaching for something on the floor.

Minimizing your distractions will improve safe driving and will help avoid an accident involving death or personal injury.

Be aware of local regulations that may prohibit the use of cellular telephones while driving. In addition to being an unsafe practice, it may be against local or federal ordinances to use cellular devices while operating the vehicle.

Much has gone into the manufacturing of your vehicle including advanced engineering techniques, rigid quality control, and demanding inspections. These manufacturing processes will be enhanced by you, the safe driver, who observes the following:

- Knows and understands how to operate the vehicle and all its controls
- Maintains the vehicle properly
- Uses driving skills wisely.

This manual is not a training manual. It cannot tell you everything you need to know about driving your vehicle. For that you need a good training program or truck driving school. If you have not been trained, get the proper training before you drive. Only qualified drivers should drive this vehicle.

For more information, refer to Department of Transportation Regulation 392.7, which states that interstate commercial motor vehicles are not to be driven unless the driver is sure that certain parts and accessories are in working order. Do not drink alcohol and drive. Your reflexes, perceptions, and judgment can be affected by even a small amount of alcohol. You could have a serious or even fatal accident, if you drive after drinking. DO NOT drink and drive or ride with a driver who has been drinking.

**WARNING**

The use of alcohol, drugs, and certain medications can impair perception, reactions, and driving ability. These circumstances can substantially increase the risk of an accident. Failure to comply may result in property damage, personal injury, or death.

**WARNING**

DO NOT text and drive. Your reaction time, perceptions, and judgment can be affected while texting or using any other form of mobile messaging while driving. Failure to comply may result in death, personal injury, equipment or property damage.

Emergency Equipment

It is good practice to carry an emergency equipment kit in your vehicle. One day, if you have a roadside emergency, you will be glad the following items are with you:

- Window scraper
- Snow brush
- Container or bag of sand or salt

- Emergency light
- Warning triangles
- Small shovel
- First aid kit
- Fire extinguisher
- Vehicle recovery hitches.

Drivers Checklist

To keep your vehicle in top shape and maintain a high level of safety for you, your passengers, and your load, make a thorough inspection every day before you drive. You will save maintenance time later, and the safety checks could help prevent a serious accident. Please remember, too, that Federal Motor Carrier Safety Regulation 392.7 requires a pre-trip inspection and so do commercial trucking companies.

You are not expected to become a professional mechanic. The purpose of your inspections is to find anything that might interfere with the safe and efficient transportation of yourself, any passengers, and your load. If you do find something wrong and cannot fix it yourself, have an authorized dealer or qualified mechanic repair your vehicle right away.

The following operations are to be performed by the driver. Performing these

checks and following the maintenance procedures in this manual will help keep your vehicle running properly.

Vehicle Loading**WARNING**

DO NOT exceed the specified load rating. Overloading can result in loss of vehicle control, either by causing component failures or by affecting vehicle handling. Exceeding load ratings can also shorten the service life of the vehicle. Failure to comply may result in death or personal injury.

**WARNING**

An unevenly distributed load or excessive load over one axle can adversely affect the braking and handling of your vehicle, which could result in an accident. Even if your load is under the legal limits, be sure it is distributed evenly. Failure to comply may result in death, personal injury, equipment or property damage.

The Gross Vehicle Weight Rating (GVWR) or the maximum front and rear Gross Axle Weight Ratings are determined by the components installed from the factory on to the vehicle and their designed specifications. (Axle weight ratings are listed on the driver's door edge.)

GVWR Gross Vehicle Weight Rating. This is the MAXIMUM WEIGHT your vehicle is allowed to carry, including the weight of the empty vehicle, loading platform, occupants, fuel, and any load. Never exceed the GVWR of your vehicle.

GCW Gross Combination Weight (GCW). This is the actual combined weight of your vehicle and its load: vehicle, plus trailer(s), plus cargo.

GAWR

Gross Axle Weight Rating. This is the total weight that one axle is designed to transmit to the ground. You will find this number listed on the driver's door edge.

Load Distribution

Be sure any load you carry is distributed so that no axle has to support more than its GAWR.

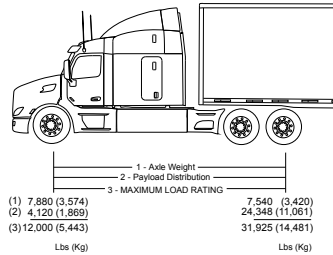

1. Axle Weight
2. Payload Distribution
3. Maximum Load Rating

Be sure that the load on the vehicle is distributed evenly across each axle so that no axle has to support more than its rated GAWR. In total, the vehicle and its load should not exceed the GAWR for each axle and must not exceed the GCW.

Visual inspection while approaching the vehicle

While approaching the vehicle, inspect the general appearance of the vehicle and its surroundings for any signs of needed attention.

**NOTE**

If equipped with a three-piece roof fairing, DO NOT DRIVE WITH ROOF FAIRING FOLDED DOWN, since the marker lamps will not be effective in that position.

Perform these basic inspection steps before operating the vehicle.

1. Check the overall appearance and condition. Are windows, mirrors, and lights clean and unobstructed?
2. Is the air-intake opening clear of obstructions?
3. Check beneath the vehicle. Are there signs of fuel, oil, or water leaks?
4. Check for damaged, loose, or missing parts. Are there parts

showing signs of excessive wear or lack of lubrication? Have a qualified mechanic examine any questionable items and repair them without delay.

5. Check your load. Is it secured properly?

Daily Checks



NOTE

These checks are in addition to, not in place of, Federal Motor Carrier Safety Regulations. These regulations may be purchased by writing to: Superintendent of Documents U.S. Government Printing Office Bookstore 710 N. Capitol St. N.W. Washington, DC 20402, or ContactCenter@gpo.gov.

Engine

- Engine oil
- Engine coolant
- Power steering fluid
- Engine belt

- Fuel filter (water separator) [Fuel System](#) on page 248
- Windshield washer fluid
- Battery cables - check the condition of the battery and alternator cables for signs of chafing or rubbing. Make sure that all clamps (straps) holding the cables are present and in good working order.
- Hood latch
- Brake lines and hoses
- Steering components - check pitman arm, drag link, tie rod, steering shaft and power steering hoses, etc., for loose, broken, or missing parts.
- Hydraulic clutch fluid

Chassis and Cab Exterior

- Lamps - are any exterior lamps cracked or damaged? Perform an exterior lamp test. See [Exterior Lighting Self-Test](#) on page 103 for more information.
- Is the air-intake opening clear of obstructions?
- Window and mirrors - clean and adjusted?

- Tires, wheels and hubs [Tires](#) on page 267 [Wheels](#) on page 271 and [Systems Check](#) on page 30
- Suspension components - check for loose or missing fasteners. Check damage to springs or other suspension parts such as cracks, gouges, distortions, bulges or chafing.
- Brake lines and hoses - check lines, linkages, chambers, parking and service brake operation.
- Air system - [Air System](#) on page 210
- Steps and grab handles
- Frame mounted tanks (fuel, diesel exhaust fluid, etc) - check underneath the vehicle for signs of fluid leaks. If any are found, correct before operating the vehicle. Is the tank fill cap secure? Are the tank straps tight? Is the strap webbing in place?
- Trailer connections - are they secure and the lines clear? If they are not being used, are they stored properly? Is the trailer spare wheel secure and inflated? Is the landing gear up and the handle secured?

- Fifth wheel - Is the kingpin or the sliding fifth wheel locked?

Cab Interior

- Seat - adjust the seat for easy reach of controls and visibility.
- Seat belts - fasten and adjust safety restraint belts (which may include restraints in the sleeper).
- Steering column - adjust for easy reach and visibility.
- Mirrors - check and readjust mirrors if necessary.
- Lamps - turn ignition key to the ON position to allow the bulb check and the systems check to test the truck systems. Perform an Exterior Light Self Test
- Instruments - check all instruments. see [Systems Check](#) on page 30
- Windshield - check operation of windshield wipers and washers.
- Horn - check operation of horn.
- Fuel - check vehicle's fuel level. Is there enough fuel?
- Diesel exhaust fluid - check level. Is there enough fluid?
- Air conditioning filters in the cab and/or sleeper - check the

condition of the sleeper air conditioning air filter. Keep the sleeper floor area behind the passenger front seat clear of debris and pet hair. The sleeper air conditioner draws air from this area and excessive dirt or pet hair may shorten the service life of the sleeper air conditioning air filter.

Weekly Checks



NOTE

These checks are in addition to, not in place of, Federal Motor Carrier Safety Regulations. These regulations may be purchased by writing to: Superintendent of Documents U.S. Government Printing Office Bookstore 710 N. Capitol St. N.W. Washington, DC 20402, or ContactCenter@gpo.gov.

Engine

- Belts
- Hoses
- Clamps
- Radiator

- Air filter and its housing
- Engine Aftertreatment system components
- Exhaust pipes
- Engine air pre-cleaner (option) - For vocational vehicles with optional engine air pre-cleaner, check the purge valve at the bottom of the hood mounted engine air pre-cleaner for any obstructions. Make sure the purge valve will open and close as needed to purge dirt and water from the engine intake air.
- Automatic transmission fluid (where applicable) - Check level, after the engine has warmed up to operating temperature.

Chassis and Cab Exterior

- Battery - check battery and terminals.
- Hood supports and guides are properly lubricated.
- Wheel cap nuts - are they all in place and torqued properly - tighten if necessary. [Wheels](#) on page 271
- Controls and wiring - check for condition and adjustment

- Steering components - check pitman arm, drag link, intermediate shaft U-joint pinch bolt, tie rod, steering shaft and power steering hoses, etc., for loose, broken, or missing parts.
- Cab air conditioner fresh air filter - check for condition and cleanliness.
- PACCAR 20k Front Axle Kingpin Joint Grease/Tie Rod Ends (option) (VOCATIONAL USE) - For vocational vehicles with this axle, grease with Heavy-Duty Multipurpose Lithium Based: #1 or #2 grade, every 50 hours. (Refer to [Front Axle and Suspension](#) on page 252 for maintenance instructions.)

Systems Check

System Check Display

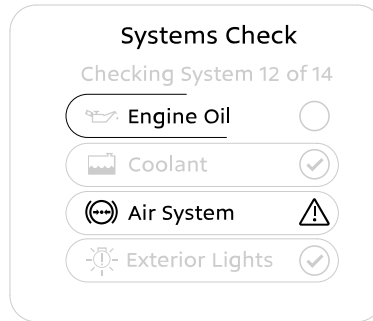

Systems Check evaluates each monitored system and displays its progress for the operator. The Systems Check will appear when the Exterior Lighting Self-Test (ELST) is activated, or when viewing the Notifications sub-menu.

Systems Check can be interrupted at any time by

- Pressing **Select**
- Switching the ELST switch to OFF
- Turning the ignition key to OFF or ACC

- Releasing the Parking Brake.
- The Systems Check can also present the following optional features.

Tire Pressure Monitoring System (TPMS) (option)

One of the systems the vehicle monitors is the Tire Pressure Monitoring System (TPMS).

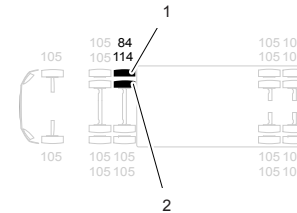

TPMS shows individual tire pressures for each location and will change the color of the tire:

- Outlined** – Tire pressure not available
- Gray** – Nominal
- Amber** – High or low pressure
- Red** – Very low or high pressure, or high temperature

To read about tires and recommended maintenance practices, see [Tires](#) on page 267.

can improve brake saving and fuel economy (see [DPA](#)).

System Check Display with TPMS

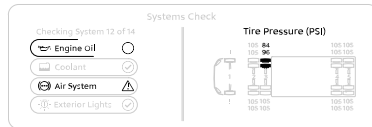

Once the Systems Check has completed, the results will display in a summary. A detailed explanation of this summary can be viewed by accessing the Menu after a Systems Check has completed.

Driver Rewards (option)

If enabled, the Driver Rewards score for Fuel Economy, Engine Idle Time, or both Fuel Economy and Engine Idle Time are shown, as well as general driving tips that can improve brake saving and fuel economy (see [Driver Rewards](#)).

Driver Performance Assistant (DPA) (option)

If enabled, The Driver Performance Assistant score for Braking Habits is shown, as well as general driving tips that

Chapter 2 | EMERGENCY

Roadside Assistance.....	33
Low Air Alarm	33
Stop Engine Light.....	34
Low Oil Pressure.....	34
Engine is Overheating.....	34
How to Inspect and Replace a Fuse.....	36
Where are the Fuses Located?.....	37
How to Jump Start a Battery.....	38
How to Recover a Vehicle.....	40

Roadside Assistance

Call toll-free to talk to someone at the PACCAR Customer Center.



1-800-4Peterbilt (800-473-8372)

The Customer Call Center is open 24/7-365 days a year and staffed with trained personnel (English and other languages if necessary), free of charge, to provide total roadside assistance. Their custom mapping system can locate the nearest Authorized dealers and Independent Service Providers (ISPs) based on the vehicle's location. In addition, the customer center can dispatch services for jump and pull starts, tires, trailers, fines and permits, chains, towing, hazardous clean-up, out of fuel (roadside), mechanical repairs, and preventive maintenance services. If they can't answer a specific question, they will direct you to a representative who can.

Low Air Alarm



If this alarm turns on while parked or driving, be sure to perform these tasks:



WARNING

If the air pressure falls below 60 psi (414 kPa) the spring brakes may stop the vehicle abruptly, which could cause an accident resulting in personal injury or death. Observe the gauges. If the warning alert comes on, do not continue to drive the vehicle until it has been properly repaired or serviced.



NOTE

The instrument cluster gauges may appear, if hidden from view, change brightness and change color to bring attention to a particular system.

1. Slow down carefully.
2. Move a safe distance off the road and stop.
3. Place the transmission in neutral (park with automatic transmissions, if equipped) and set the parking brake.
4. Turn OFF the engine.
5. Turn ON the emergency flasher and use other warning devices to alert other motorists.

If the light and alarm do not turn off at start-up, DO NOT try to drive the vehicle until the problem is found and fixed.

Stop Engine Light



This warning light illuminates when the engine has a serious problem. This is an emergency and the vehicle should be safely stopped at the soonest opportunity.



WARNING

This should be considered an emergency. You should stop the vehicle as safely as possible and turn OFF the ignition. The vehicle must be serviced and the problem corrected before driving again. Failure to do so may cause severe engine or Diesel Particulate Filter damage, or cause an accident which may result in death or personal injury.

Low Oil Pressure



CAUTION

Continuing to operate your vehicle with insufficient oil pressure will cause serious engine damage. Failure to comply may result in equipment or property damage.

It is important to maintain oil pressure within acceptable limits. If oil pressure drops below the minimum psi (kPa) the oil pressure gauge will illuminate and change color. Additionally, the Stop Engine Lamp will turn red.



NOTE

The instrument cluster gauges may appear, if hidden from view, change brightness and change color to bring attention to a particular system.

1. Slow down carefully.

2. Move a safe distance off the road and stop.
3. Place the transmission in neutral (park with automatic transmissions, if equipped) and set the parking brake.
4. Turn OFF the engine.
5. Turn ON the emergency flasher and use other warning devices to alert other motorists.
6. Wait a few minutes to allow oil to drain into the engine oil pan, and then check the oil level.
7. Add oil if necessary. If the problem persists, contact an authorized dealer as soon as possible.

Engine is Overheating



**CAUTION**

The cooling system may overheat if the engine coolant is at the minimum level. A sudden loss of coolant, caused by a split hose or broken hose clamp could also lead to an overheat condition. Always inspect to ensure hoses and clamps are not cracked, worn, or loose. Failure to comply may result in equipment or property damage.

**NOTE**

The system may also temporarily overheat during severe operating conditions such as:

- Climbing a hill on a hot day
- Stopping after high-speed/high-load driving
- Debris blocking air flow through the cooling module (radiator)

If the engine coolant temperature warning lamp comes on and the audible alarm sounds showing an overheat condition, or if you have any other reason to suspect the

engine may be overheating, DO NOT TURN OFF THE ENGINE unless a low water warning device indicates a loss of coolant.

Follow these steps if the engine coolant temperature is rising, or the temperature is already above normal, and there are no other warning alarms displayed in the instrument cluster.

**NOTE**

The instrument cluster gauges may appear, if hidden from view, change brightness and change color to bring attention to a particular system.

1. Reduce engine speed, or stop. When stopped, place the transmission in neutral (N) and set the parking brake. Keep the engine running.

**WARNING**

To reduce the chance of personal injury, vehicle damage, and/or death from overheated engines, which can result in a fire, never leave the engine

idling without an alert driver present. If the engine does overheat, as indicated by the engine coolant temperature lamp, immediate action is required to correct the condition. Continued unattended operation of the engine, even for a short time, may result in serious engine damage or a fire. Failure to comply may result in death, personal injury, equipment or property damage.

**WARNING**

Removing the fill cap on a hot engine can cause scalding coolant to spray out and burn you badly. If the engine has been in operation within the previous 30 minutes, be very careful in removing the fill cap. Protect face, hands, and arms against escaping fluid and steam by covering the cap with a large, thick rag. DO NOT try to remove it until the surge tank cools down or if you see any steam or coolant escaping. Always remove the cap very slowly and carefully. Be ready to back off if any steam or coolant begins to escape.



NOTE

Keep the engine running at idle speed unless a warning icon turns on that requires the engine to be shut off.

2. Check to ensure the Oil Pressure Gauge reads normal.
3. Make sure the engine fan is turning by switching the **Engine Fan Switch** from AUTO to MAN (Manual).
4. Idle the engine to see if this reduces the coolant temperature. If the temperature does not begin to drop, shut off the engine and contact your nearest authorized dealer.
5. If the temperature begins to return to normal, allow the engine to idle 3 to 5 minutes before shutting it off. This allows the engine to cool gradually and uniformly.
6. If overheating came from severe operating conditions, the temperature should have cooled by this time. If it has not, stop the engine and let it cool before checking to see if the coolant is low.

7. Be sure the vehicle is parked on level ground or the readings may be incorrect. Check the coolant level at the coolant surge tank.

Check the coolant level after each trip when the engine has cooled. The coolant level should be visible within the surge tank. Add coolant if necessary.

How to Inspect and Replace a Fuse

Turn the ignition off and turn all lights off.



WARNING

DO NOT replace a fuse with a fuse of a higher rating. Doing so may damage the electrical system and cause a fire. Failure to comply may result in property damage, personal injury, or death.



CAUTION

Never patch fuses with tin foil or wire. This may cause serious damage else-

where in the electrical circuit, and it may cause a fire.



CAUTION

If a circuit keeps blowing fuses, have the electrical system inspected for a short circuit or overload by an authorized dealer as soon as possible. Failure to do so could cause serious damage to the electrical system and/or vehicle.



CAUTION

Before replacing a fuse, turn OFF all lights and accessories and remove the ignition key to avoid damaging the electrical system.

1. Turn OFF all lights and accessories and remove the ignition key to avoid damaging the electrical system.
2. Determine from the chart on the fuse panel which fuse controls that component.

- 3. Remove that fuse and see if it is blown.

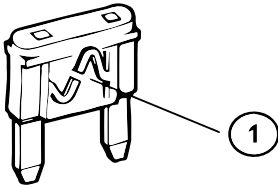

1 Blown

Fuse Puller

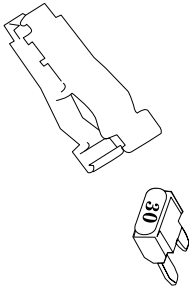

If it is blown, replace it with a fuse of the same rating. If a fuse of the same rating is not available, a fuse of a lower rating may be temporarily substituted. You can also use a fuse from a circuit you can do temporarily without (for example an accessory circuit or radio).

CAUTION

When replacing a failed circuit breaker, always use an approved circuit breaker with a current rating equal to or less

than the circuit breaker being replaced. Only use the approved Type II modified reset circuit breakers. NEVER use a Type I (automatic reset) or Type III (manual reset) circuit breaker. A fuse with a current rating equal to or less than the circuit breaker being replaced can also be used.

CAUTION

Always close and latch the engine compartment fuse box cover. A latched cover ensures a water tight seal which can prevent damage to electrical components.

Where are the Fuses Located?

Fuses for the cab are located in the fuse panel behind the drivers side kick panel. Main power relays are located on the power distribution center mounted to the front wall of the cab.

Fuses for the optional sleeper are located on a separate fuse box accessible through the luggage compartment door.

How to Jump Start a Battery

Jump starting a vehicle is not a recommended practice due to the various battery installations and electrical options. However, if the vehicle battery is discharged (dead), the vehicle may be jump started (using energy from a good battery in another vehicle).



WARNING

Batteries contain acid that can burn and gases that can explode. Ignoring safety procedures may result in death, personal injury, equipment or property damage.



WARNING

Never jump start a battery near fire, flames, or electrical sparks. Batteries

generate explosive gases that could explode. Keep sparks, flames, and lighted cigarettes away from batteries. Failure to comply may result in property damage, personal injury, or death.



WARNING

Never remove or tamper with battery caps. Ignoring this could allow battery acid to contact eyes, skin, fabrics, or painted surfaces. Failure to comply may result in death, personal injury, equipment or property damage. Be careful that metal tools (or any metal in contact with the positive terminal) do not contact the positive battery terminal and any other metal on the vehicle at the same time. Remove metal jewelry and avoid leaning over the battery.



WARNING

When jump starting using a battery charger/booster, verify that the battery charger/booster is set to the same jump start voltage and amperage specifications as the vehicle electrical system

and batteries (i.e., if the vehicle electrical system is a 12 volt system, the jump start voltage on the battery charger/booster shall be set at no higher than a 12 volt setting). Failure to comply may cause an explosion and/or fire resulting in death, personal injury, and/or equipment or property damage.



WARNING

Heed all warnings and instructions of the jumper cable manufacturer. Failure to comply may result in death, personal injury, equipment or property damage.



CAUTION

Applying a higher voltage booster battery will cause expensive damage to sensitive electronic components, such as relays and the radio. Failure to comply may result in equipment damage.

**CAUTION**

Improper hook-up of jumper cables or not following these procedures can damage the alternator or cause serious damage to both vehicles.

1. Remove any jewelry that may come in contact with the battery terminals.
2. Select a jumper cable that is long enough to attach to both vehicles in a way that ensures neither vehicle touches each other.
3. Position the two vehicles together, but do not allow them to touch.
4. Turn OFF all lights, heater, radio, and any other accessory on both vehicles.
5. Set the parking brake.
6. Shift the transmission into park position or neutral for manual transmissions.
7. If either vehicle is equipped with battery disconnects ensure they are in the OFF position prior to connecting the two vehicles.

8. Attach one end of a jumper cable to the positive (+) terminal of the discharged (dead) battery. This will have a large red + or P on the battery case, post, or clamp.
9. Attach the other end of the same cable to the positive (+) terminal of the good (booster) battery.
10. Attach the remaining jumper cable FIRST to the negative (-) terminal (black or N) of the good battery.
11. Attach the other end of the negative cable to a bare metal part not bolted to the engine block.

**NOTE**

Always connect positive (+) to positive (+) and negative (-) to negative (-).

12. If either vehicle is equipped with battery disconnects, ensure that they are in the ON position.
13. Start the vehicle that has the good battery first.
 - Let it run for 5 minutes.
14. Start the vehicle that has the discharged (dead) battery.

The engine should start. If the engine fails to start, do not continue to crank the

starter. Instead, contact the nearest authorized dealer.

**WARNING**

When disconnecting jumper cables, make sure they do not get caught in any moving parts in the engine compartment. Failure to comply may result in death, personal injury, equipment or property damage.

Reverse the above procedure exactly when removing the jumper cables. With engine running, disconnect jumper cables from both vehicles in the exact reverse order, making sure to first remove the negative cable from the vehicle with the discharged battery.

How to Recover a Vehicle



CAUTION

Remove the drive axle shafts or lift the driving wheels off the ground before towing the vehicle. Towing the vehicle with either the wheels on the ground or the axle shafts in the axles will cause damage to the axle gears.



CAUTION

If your vehicle has a Meritor axle with a driver-controlled main differential lock, install the caging bolt before removing the axles for towing, see How to Manually Lock a Differential. Installing the caging bolt prevents damage by locking internal axle components in position.



CAUTION

Connect recovery rigging only to hitch-eyes intended for that purpose. **DO NOT**

attach to bumpers or brackets. Use only equipment designed for this purpose. Failure to comply may result in equipment damage.



WARNING

Before towing a vehicle, test your air brakes to ensure that you have properly connected and inspected the recovery vehicle's brake system. Failure to do so could lead to a loss of vehicle control which may result in an accident involving death or personal injury.

All lubricating and clutch application oil pressure is provided by an engine-driven pump, which will not work when the engine is stopped. You could seriously damage your vehicle by towing it with the driveline connected and the drive wheels on the ground. Worse, when vehicles are towed, either by wrecker or piggyback, the lubricant in the top front of the drive axle will drain to the rear. This will leave the top components dry. The resulting friction may damage them. Always remove the main drive axle shafts before towing your vehicle.

1. Review and understand all the cautions and warnings of this section.
2. Disconnect the drive axle shafts and cover the open hubs. This is necessary because if the transmission is driven by the driveshaft (rear wheels on the ground), no lubricant will reach the gears and bearings, causing damage to the transmission. .

See [How to Prepare the Axles for Towing](#) on page 44

3. Connect the towing chain or cable using best recovery practices .

See [Best Practices for Recovery Rigging](#) on page 47

4. Make sure the recovered vehicle's parking brakes are released. .

See [Manually Release the Parking Brake](#) on page 41

5. If you desire to use the recovered vehicle's brakes, ensure that the vehicle's air system is connected to that of the recovery vehicle. Ensure that any air line that has been removed from a driver-controlled main differential lock is firmly capped to prevent loss of air pressure from the recovery vehicle

if it is supplying air pressure. If you don't desire to use the recovered vehicle's brakes, ensure that you cage the spring brakes before attempting to move the vehicle.

See [How to Manually Lock a Differential](#) on page 45

6. Follow state/provincial and local laws that apply to vehicles in tow.
7. Do not tow vehicles at speeds in excess of 55 mph (90 km/h).

For additional information concerning heavy duty truck recovery, refer to the following Technology & Maintenance Council (TMC) literature.

- Recommended Practice #602-A — "Front Towing Devices For Trucks and Tractors"
- Recommended Practice #602-B — "Recovery Attachment Points For Trucks, Tractors, and Combination Vehicles"
- Recommended Practice #626 — "Heavy Duty Truck Towing Procedures"

Copies of these can be obtained from the following address: Technology & Maintenance Council 950 N. Glebe Road (703) 838-1763 Arlington, VA 22203 Email:

tmc@trucking.org Website: <http://tmc.truckline.com>

Manually Release the Parking Brake

There may be times when there is not enough air pressure, or the engine's air compressor is not able to produce enough pressure, to release the parking brakes. In such cases, the parking brakes (or Spring Brakes) can be manually released.



WARNING

DO NOT drive vehicle with malfunctioning brakes. If one of the brake circuits becomes inoperative, braking distances will increase substantially and handling characteristics while braking will be affected. You could lose control of your vehicle or cause an accident. Have it towed to the nearest dealer or qualified repair facility for repair. Failure to comply may result in property damage, personal injury, or death.



WARNING

DO NOT operate a vehicle when the spring brakes have been manually released. Driving a vehicle after its spring brakes are manually released is extremely dangerous. The brakes may not function. Failure to comply may result in death, personal injury, equipment or property damage.



WARNING

DO NOT disassemble a spring brake chamber. These chambers contain a powerful spring that is compressed. Sudden release of this spring may result in death or personal injury.

**WARNING**

Releasing the spring brakes on an unsecured vehicle could lead to an accident. The vehicle could roll, which may result in death, personal injury, equipment or property damage. Always secure the vehicle with wheel chocks, chains, or other safe means to prevent rolling before manually releasing the spring brakes.

2

To move a vehicle immobilized by the spring brakes due to loss of air pressure in the brake system, perform the following procedure:

1. Remove the cap from the spring chamber



2. Remove the release stud assembly from the side pocket, and remove the release nut and washer from the release stud.

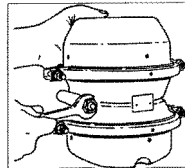

3. Slide out the release stud.

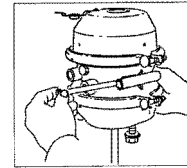

4. Insert the release stud through the opening in the spring chamber where the cap was removed. Insert it into the pressure plate. Turn the release stud 1/4 turn clockwise in the pressure plate. This secures the cross pin into the cross pin area of the pressure plate and locks it into the manual release position.

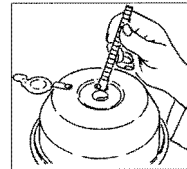

5. Assemble the release stud washer and nut on the release stud.

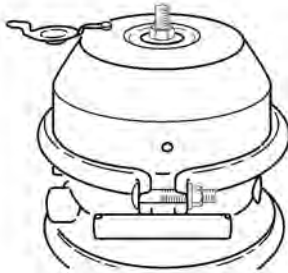

6. With a wrench, turn the release stud assembly nut until the compression spring is 90-95 percent caged. While doing this, check to make sure the push rod (adapter push rod or service push rod) is retracting. DO NOT over-torque the release stud assembly. (S-Cam-type maximum: 50 lb-ft (68 N·m), Wedge-type maximum: 30 lb-ft (41 N·m)). The spring brake is now mechanically released.

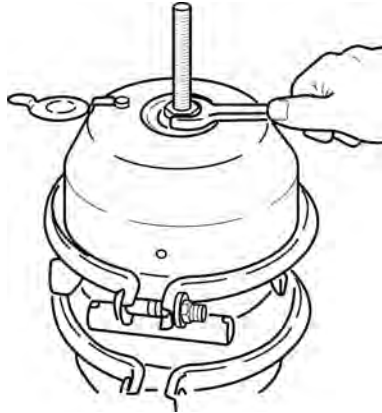

Recovery Hitch

A removable recovery hitch is a device that attaches to the sockets in the front bumper in the event that the vehicle needs to be recovered. These hitches are designed for short distance and intermittent duty to help pull a vehicle. These hitches are not designed to be used as towing devices for long distance.

Specially designed hitches are required to recover your vehicle. The recovery hitches attach to the frame. Two hitch assemblies, made up of the following parts, are

recommended for the proper recovery of your vehicle:

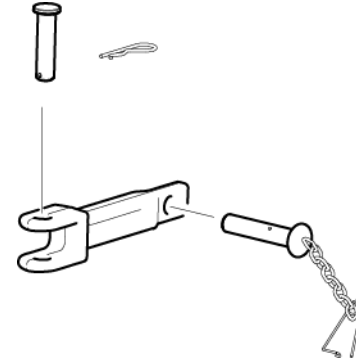

If your vehicle is not equipped with the proper recovery hitch assembly, contact an authorized dealer to obtain the proper equipment.

**WARNING**

DO NOT use parts from other trucks or materials from other sources to repair a hitch or to replace a missing hitch. The parts provided for recovery are made of high strength materials and are specifically designed for vehicle recovery. Failure to use the correct factory equipment may result in an accident involving death or personal injury.

**CAUTION**

Connect recovery rigging only to hitches intended for that purpose. DO NOT attach to bumpers or brackets. Use only equipment designed for this purpose. Failure to comply may result in equipment damage.

How to use a Recovery Hitch**CAUTION**

Recovery pull maximums assume the tow rigging evenly distributes the load between both recovery hitches. See examples in Recovery Rigging for details. Serious damage to the vehicle may occur if rigging is not connected properly.

**CAUTION**

When recovering ditched or bogged vehicles, stay well below Maximum Capacities. Even at loads below maximum, the physical strain of recovering a vehicle could damage axles, suspensions, fifth wheels, etc.

Use the following procedure to install the Vehicle Recovery Hitches. See Recovery Hitch Assembly illustration for part identification.

1. Check the square sockets behind lower bumper for obstructions, clear if necessary.

2. With lock pins removed, insert the hitches through the bumper and into the square hitch socket.
3. Align the hole in the tow hitch with the square hitch socket hole.
4. Insert the lock pin into the square hitch socket hole and through the hole in the tow hitch until the lock tab is within the square hitch socket.
5. Rotate the lock pin 90 degrees to secure the pin in place.
6. Ensure that the tow pin and lock clip are installed before using the hitch.
7. Remove the hitches and store all parts after recovering the vehicle.

How to Prepare the Axles for Towing

If the vehicle is going to be towed from the front axle and using the rear axle for support, then the axle shafts should be prepared [removed] so that minimal damage is made to the differential during the towing process.

Ensure that the recovered vehicle does not have an open air line. An open air line on the recovered vehicle will cause a leak in the air system of the recovery vehicle if

both vehicles' brake systems are connected. This could cause a loss of system air, which can cause the service brakes not to function, resulting in the sudden application of the spring brakes causing wheel lock-up, loss of control, or overtake by following vehicles.

**WARNING**

An open air line on the recovered vehicle will cause a leak in the air system of the recovery vehicle if both vehicles' brake systems are connected. This could cause a loss of system air, which can cause the service brakes not to function, resulting in the sudden application of the spring brakes causing wheel lock-up, loss of control, or overtake by following vehicles. You could be in an accident involving personal injury or death. Ensure that any air line that has been removed from a driver-controlled main differential lock is firmly capped to prevent loss of air pressure from the recovery vehicle if it is supplying air pressure.

1. Lift driving wheels off the ground or remove the driveline and axle shafts before towing the vehicle.

**CAUTION**

Failure to lift the driving wheels off the ground or remove the driveline and axle shafts before towing the vehicle could seriously damage your vehicle. All lubricating and clutch application oil pressure is provided by an engine-driven pump, which does not work when the engine is stopped. When vehicles are towed either by wrecker or piggyback, lubricant in the top front of the drive axle will drain to the rear. This will leave the top components dry, resulting in friction that will seriously damage these components.

2. If the vehicle has driver controlled differential lock, then manually lock the differential.
3. Remove drive axle shafts.
4. Cover the open ends of the hubs to prevent dirt and debris from entering the axle.

**CAUTION**

Water, dirt, and other material can enter an open hub or axle. This can contaminate the axle fluid and cause possible damage to components. Ensure that the hubs are covered with plastic whenever a drive axle shaft is removed.

How to Manually Lock a Differential

Follow these procedures if the vehicle has a driver controlled differential lock. Always lock the differential when the axles are being removed to aid in re-installation. This procedure should be done before the axle shafts are removed.

**CAUTION**

Failure to install the caging bolt when towing vehicles with driver-control main differential lock can result in damage by failing to lock internal components in position.



WARNING

An open air line on the recovered vehicle will cause a leak in the air system of the recovery vehicle if both vehicles' brake systems are connected. This could cause a loss of system air, which can cause the service brakes not to function, resulting in the sudden application of the spring brakes causing wheel lock-up, loss of control, or overtake by following vehicles. You could be in an accident involving personal injury or death. Ensure that any air line that has been removed from a driver-controlled main differential lock is firmly capped to prevent loss of air pressure from the recovery vehicle if it is supplying air pressure.



CAUTION

A recovered vehicle will have no operational brake system. Additionally, the rear axle spring brakes will probably be applied.

- If you desire to use the recovered vehicle's brakes, ensure that the vehicle's air system is connected to that of the recovery vehicle. Also ensure that any air line that has been removed from a driver-controlled main differential lock is firmly capped to prevent loss of air pressure from the recovery vehicle.
- If you don't want to use the recovered vehicle's brakes, ensure that you cage the spring brakes before attempting to move the vehicle.

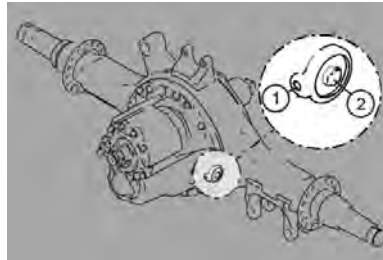

1. Remove the air line and firmly cap the air line from the vehicle. (2)
2. Remove the caging bolt from its storage hole. (1)
3. Screw the caging bolt into the air line hole. (2)

4. When fully engaged, a 0.25-0.5 in. (6.35-12.7 mm) space will remain between the air cylinder and the bolt head. This action will lock the differential by pushing a piston into a "lock" position.

Recovery Hitch Capacities

The maximum rated loads for vehicle recovery varies depending on the direction or angle of pull. These capacities are listed in the table below and are for the two hitches working together, simultaneously.

Direction of Pull	Maximum Capacity lbs. (kg)
Directly forward	80,000 (36,000)
Directly vertical or horizontally to the side	14,600 (6,600)
45 degrees in any direction	20,000 (9,000)

Best Practices for Recovery Rigging



CAUTION

Recovery pull maximums assume the tow rigging evenly distributes the load between both recovery hitches. See examples in Recovery Rigging for details. Serious damage to the vehicle may occur if rigging is not connected properly.



CAUTION

When recovering ditched or bogged vehicles, stay well below Maximum Capacities. Even at loads below maximum, the physical strain of recovering a vehicle could damage axles, suspensions, fifth wheels, etc.

Recovery Rigging Options

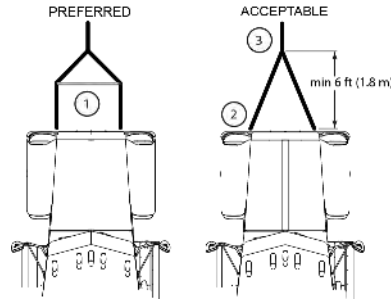

Use a double chain or cable setup that distributes the load equally to both hitches (see either example in Recovery Rigging Options illustration):

- Never loop a single chain or cable through both hitches, also known as reeving (not shown).
- Use a spreader or equalizer bar to distribute the load on both hitches (1), or
- If no spreader bar is available, connect the main tow chain or cable no closer than 6 ft. (1.8 m) from the vehicle: (2) to (3).
- Secure the towed vehicle using two additional chains or cables (see *Safety Chains*) (not shown).

Returning to Service After Recovering

Once the vehicle is recovered, the axles need to have oil added to prevent gear damage during operation.

1. Into the pinion cage, add 1 pint (.47 liter) of lubricant or into the interaxle differential, add 2 pints (.94 liter) of approved lubricant.
2. After adding the specified type and amount of lubricant, drive the vehicle. It should be unloaded. Drive 1 to 2 miles (1.5 to 3 km) at a speed lower than 25 mph (40 km/h). This will thoroughly circulate the lubricant through the assembly.
3. If the parking brakes were manually released, they will need to be modified back to their normal operating condition.
4. If the differential lock was manually locked, then the caging bolt needs to be put back in its storage location and the differential lock air line needs to be re-installed in its normal position.

Add lubricant back to the axles after recovering the vehicle and before putting it back into service.

What to do if the Vehicle is Stuck in Sand, Mud, Snow or Ice



WARNING

DO NOT spin the wheels faster than 35 mph (55 km/h). Spinning a tire at speedometer readings faster than 35 mph (55 km/h) can be dangerous. Tires can explode from spinning too fast. Under some conditions, a tire may be spinning at a speed twice that shown on the speedometer. Any resulting tire explosion could cause injury or death to a bystander or passenger, as well as extensive vehicle damage: including tire, transmission, and/or rear axle malfunction.

These suggestions are provided to improve the ability to free a vehicle if the vehicle gets stuck in sand, mud, snow, or ice:

- Move the gearshift lever or selector from First to Reverse
- Apply light pressure on the accelerator pedal while the transmission is in gear
- Remove your foot from the accelerator while shifting
- Do not race the engine

- For best traction and safety, avoid spinning the wheels

Follow these practices to avoid transmission damage:

- Always start vehicle in motion with the shift lever in first gear.
- Be sure that transmission is fully engaged in gear before releasing the clutch pedal (manual only).
- Do not shift into reverse while the vehicle is moving.
- If the vehicle needs to be recovered from being stuck, do not permit the vehicle to be towed for long distances without removing the driveshaft.

If tire chains are needed, make sure they are installed on both sides of the driving axle. Installing chains on only one side of the axle can cause equipment damage.



CAUTION

Chains on the tires of only one tandem axle can damage the driveline U-joints and the inter-axle differential. Repairs could be costly and time-consuming.

Failure to comply may result in equipment damage.

Towing the Vehicle

A dealer or commercial towing service will have the necessary equipment to safely tow the vehicle and should be able to make arrangements to limit any damage to the vehicle. The towing service and the dealer should be aware of towing regulations and safety precautions.

The towing service will ensure that the following precautions are taken:

- Use of a safety chain system
- Abide by all local towing regulations
- Ensure that the towing device does not contact any surfaces that could be damaged while in transit
- If towing from the front, ensure that the rear axles are prepared for towing
- If towing from the rear, ensure that all body components such as roof, side, and chassis fairings are secured properly to avoid damage while in transit

**WARNING**

Secure the roof, side, and chassis fairings while towing from the rear. An unsecured fairing may come off of the vehicle during transit. Failure to secure the fairings while towing may cause an injurious accident resulting in death or personal injury.

Chapter 3 | CONTROLS

3

Instrument Cluster.....	52
Peterbilt Digital Display Controls.....	54
Peterbilt Digital Display.....	55
Selecting a View.....	59
Configure Settings.....	64
Drive Summary.....	69
Driver Rewards (option).....	69
Driver Performance Assistant (option).....	70
Bulb Check.....	71
Guide to the Warning Symbols.....	73
Optional Gauges.....	83
Dash Switches.....	84
Door Mounted Mirror Controls.....	97
Steering Column Controls.....	99
Steering Wheel Controls.....	102
Ignition Key Switch.....	103

Exterior Lighting Self-Test.....	103
Test the Exterior Lights.....	103
Heating and Air Conditioning.....	104
Air Conditioner Control Panel.....	105
How to Manually Control the Air Conditioner for the Cab.....	107
Sleeper Heater and Air Conditioner Controls (Option).....	109
Sleeper Alarm Clock.....	109
Cab Accessories.....	110

Instrument Cluster

For information on using the dash and instrument cluster options while driving,

see the paragraphs that follow. Please remember that each vehicle is custom-made. Your instrument panel may not look exactly like the one in the pictures that follow. We have tried to describe the most

common features and controls available. You can pick out the parts that apply to you and read them to be fully informed on how your particular vehicle operates.

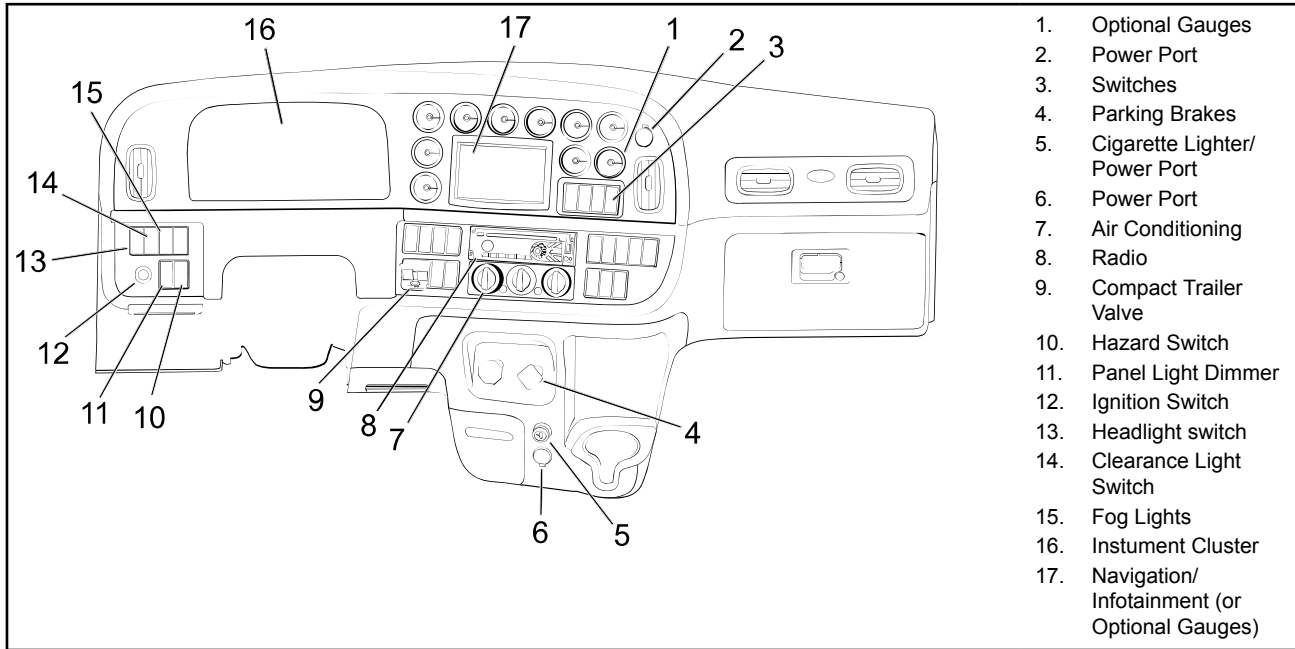

Peterbilt Digital Display Controls

3

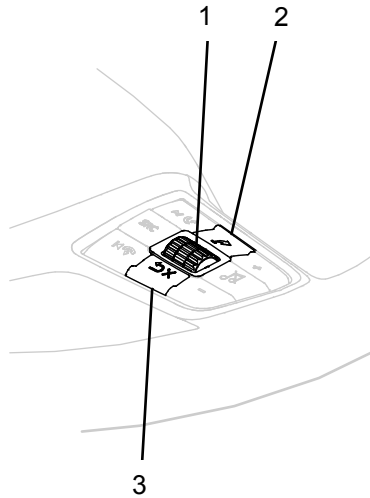

1. Scroll Wheel
2. Shortcut
3. Back/Cancel

The controls located on the right pod of the steering wheel are used to select Drive

View, navigate and select items in the Menu, and view Popup messages. The shortcut button will access items that are configured in the settings, [Shortcuts](#) on page 68.

Scroll Wheel

Use the Scroll Wheel to navigate through menus and press down to select menu options, change settings when in the menu, and switch between Views.

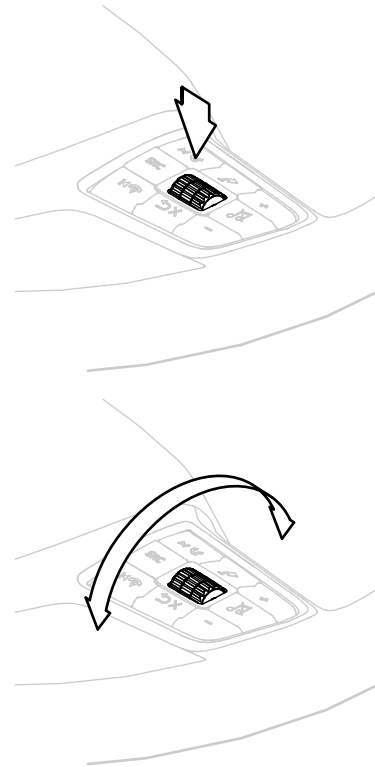

For example, press down and then scroll to access the clock menu. Then press down and scroll again to adjust the clock values. Press down to select the menu:

Menu Example: main Menu

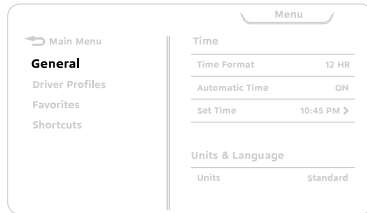

Press again to select the sub-menu:

Menu Example: Settings

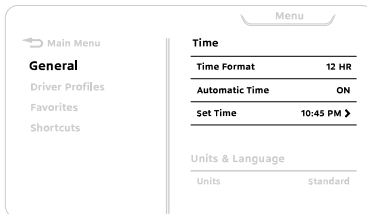

Use the Scroll Wheel to scroll through the values then press down to select.

Menu Example Set Function

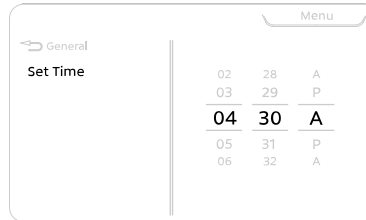

Back

Use the **Back** button to return to the previous menu, suppress a popup , or cancel a selection. *Popups* on page 73.

the following actions will wake the display, making it visible:

- Opening (or keeping open) the cab doors
- Using steering wheel switches
- Tapping the brake
- Turning the ignition switch to ON, ACC, or START
- Starting the engine.

If after 20 seconds none of these actions are taken, the display will darken to conserve power, but will awaken if any wake action is performed. If the Anti-Theft option is active and you attempt to start the engine, a passcode prompt will appear; the engine cannot be started until the correct passcode is entered (see *Anti-Theft* on page 68).

Peterbilt Digital Display

The digital display will stay visible during all driving situations and in some parked situations. When the parking brake is set

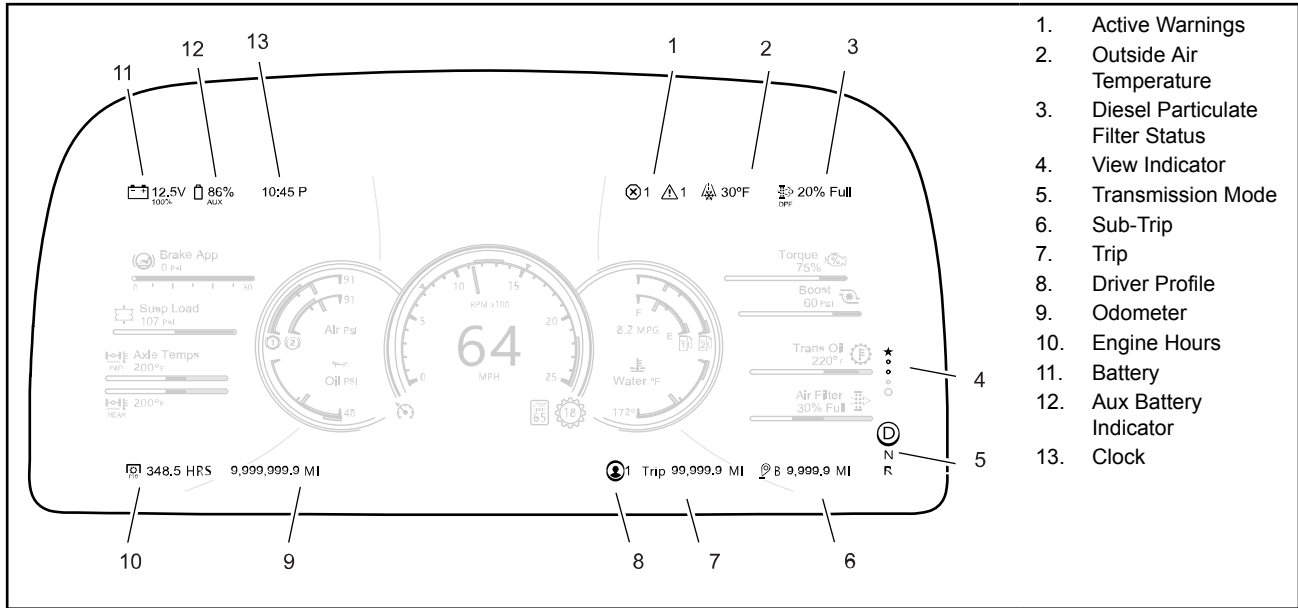

1. Active Warnings
2. Outside Air Temperature
3. Diesel Particulate Filter Status
4. View Indicator
5. Transmission Mode
6. Sub-Trip
7. Trip
8. Driver Profile
9. Odometer
10. Engine Hours
11. Battery
12. Aux Battery Indicator
13. Clock

Active Warnings

Red or amber popups are counted and the total is displayed by the active warning indicator. In addition, these counts are also presented in

- Systems Check
 - The Notifications Sub-menu
 - A Drive Summary
- The numbers may change without user interaction if individual warnings are

intermittent, time based, self correcting, or the situation is rectified.

Outside Air Temperature

Outside Air Temperature monitors the ambient temperature outside the truck

The display will alert the driver to high and low temperature conditions. When the outside temperature approaches freezing (36°F or 2°C) an icon will appear next to the temperature (snowflake for freezing and thermometer for high) and a chime will sound. The system's unit of measure (Fahrenheit or Celsius) can be changed by navigating to the settings menu. The outside air temperature display uses a sensor (located at the bottom of the driver's side mirror assembly) to measure outside air temperature only. It is not capable of displaying the temperature of the road surface on either the temperature display or the snowflake icon. Additionally, the outside air temperature reading may be affected by exposure to direct sunlight.

Diesel Particulate Filter (DPF) Status

The Diesel Particulate Filter indicator shows the soot load percentage. This indicator will change colors as the soot load increases (see Guide to the Warnings Symbols or your Engine Aftertreatment Operator Manual for more details).

View Indicator

The View Indicator identifies which view is currently selected:

- Favorites (if enabled)
- Minimized
- Minimized with Advance Driving Assistance (Optional)
- Basic
- Enhanced

Drive, Neutral, and Reverse Indicator

The Drive, Neutral, and Reverse Indicator reflects the shifter position of an Automatic Transmission. Manual transmissions and certain automatic transmission do not provide feedback to the display. Instead, the transmission shifter indicates the gear condition.

Sub-trip Odometer

The Trip Odometer can be split into smaller segments called Sub-trips. Start a Sub-trip by pressing **Trip** on the steering wheel. The maximum distance that the sub-trip will show is 9,999.9 at which point it will start over at zero. When it maxes out, the current sub-trip ends and begins a new one. Sub-trip information is also found in

the settings menu [Trip Summary](#) on page 64.

Trip Odometer

The Trip Odometer shows how far the vehicle has gone traveled since last it was reset. The maximum distance that can be shown on the Trip Odometer is 99,999.9 at which point the operator needs to reset.

Press **Trip** to set. Press and hold **Trip** to reset (Item 1 in following image).

Left Switch Pod

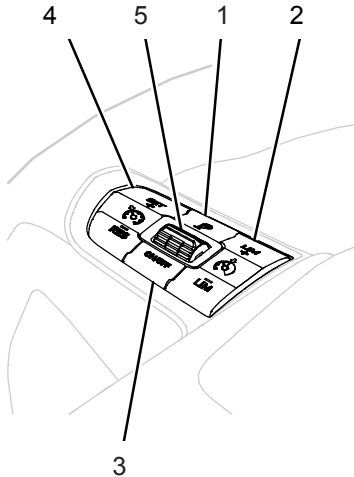

1. Trip marker
2. Limiter control
3. Cruise control ON/OFF
4. Cruise control set/resume

5. Toggle switch

The operator may also use the trip summary to view the same information [Trip Summary](#) on page 64.

Driver Profile Indicator

The number following the icon indicates which driver is active when Driver Profiles are enabled. For information on Driver Profiles, [Choosing the Active Driver Profile](#) on page 66.

Odometer

The odometer displays the total distance your vehicle has traveled. The maximum distance that can be shown on the odometer is 9,999,999.9. The odometer will roll over to zero if maximum mileage is achieved.

Engine Hours

Engine hours will display the total number of hours the engine has been operated. The maximum hours that can be shown are 99,999.9 before the counter rolls over to zero.

Battery Voltage

The Battery Voltage indicator shows the battery icon, voltage, and the state of charge. The battery icon will be replaced with the Low Voltage Disconnect (LVD) icon when Low Voltage Disconnect is active. The battery icon is gray when operating normally, but changes to amber to indicate a low voltage condition and red to indicate a high or very low voltage condition.

Clock

The clock can be displayed in a 12-hour or 24-hour format. Clock settings can be altered in the Settings Sub-menu.

Transmission Gear Display

Vehicles with PACCAR or Eaton automated transmissions will show the transmission mode, current gear, and diagnostic information associated with the transmission. Vehicles with manual transmissions will show the current gear. This display does not apply for vehicles with Allison transmissions.

Selecting a View

The instrument cluster has 5 views for the operator to use.

- Favorites
- Minimized
- (Optional) Minimized with Advanced Driver Assistant
- Basic View
- Enhanced View

Each view is identified by a specific view indicator on the right side of the display area.

Minimized View

A combination speedometer and tachometer will show in the center of the Minimized View.

Speedometer and Tachometer

Vehicle and engine speed are presented at the center of the display. Units for vehicle

speed can be changed to either Standard or Metric in the Digital Display menu (see [Units and Language](#) on page 64) or by using the steering wheel **Shortcut** button (see [Peterbilt Digital Display Controls](#) on page 54).

Minimized View with Adaptive Cruise Control (Option)

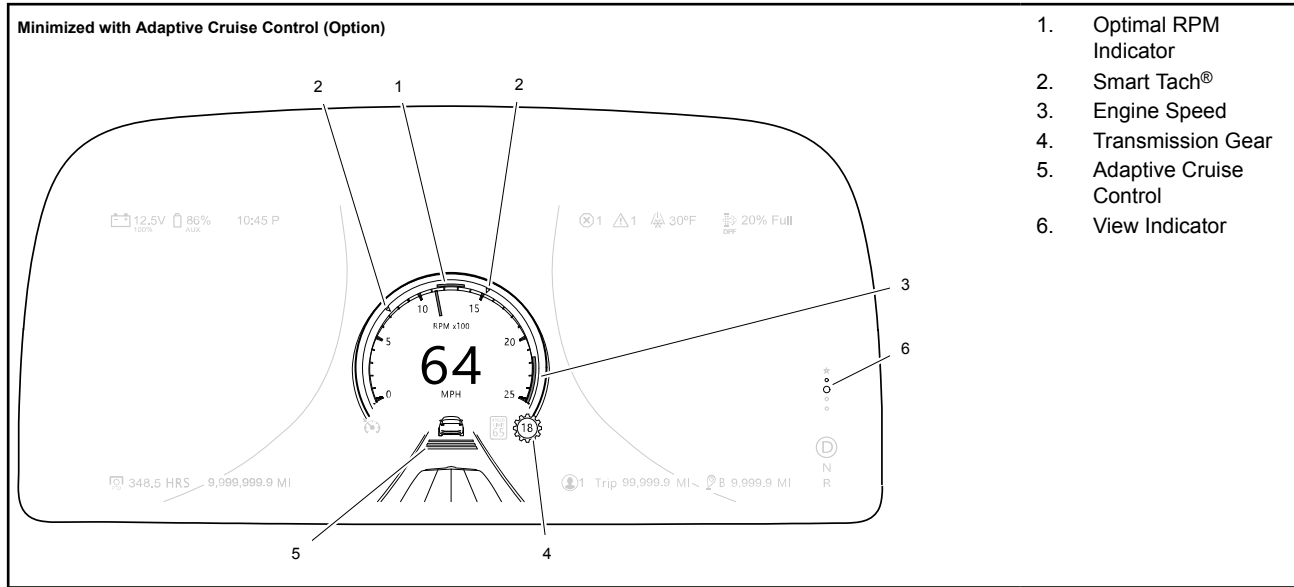

Adaptive Cruise Control Notification (option)

This indication at vehicle start means it is equipped with Adaptive Cruise Control (ACC) and Collision Mitigation. These

features work together to improve driver safety and enhance the driving experience.



Adaptive Cruise Control Installed
Review Manual

When Cruise Control is active, ACC will accelerate and slow the truck to maintain a chosen distance from a detected forward vehicle. Collision Mitigation will attempt to prevent a forward collision when advancing at speeds greater than 15 mph (24 kph). Please review the ACC section of this

manual, and the manufacturer's manual, prior to driving this vehicle.

Basic View and Enhanced View

Enhanced View

1. Gauges for Basic View and Enhanced View
2. Gauges for Enhanced View only

Basic View

This view combines the instrumentation presented in Minimized View with gauges such as Fuel and DEF level.

Enhanced View

This view includes all the gauges present in the Basic View, adding gauges on the left and right in the display. Enhanced View

is designated by the bottom icon in the View Indicator.

Gauges

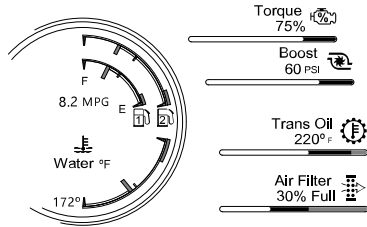

Gauge locations may be customizable and the gauge can react depending on the readout indicated. (*Favorites* on page 66) Some gauges are a flat bar rather than a typical dial gauge.

i NOTE

The instrument cluster gauges may appear, if hidden from view, change brightness and change color to bring attention to a particular system.

Diesel Exhaust Fluid (DEF)

The diesel exhaust fluid gauge shows the approximate amount of DEF fluid in the DEF tank.

DEF Level Gauge

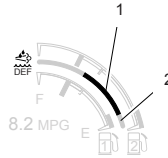

⚠ CAUTION

Use Diesel Exhaust Fluid only. Failure to do so may damage components of the Diesel Particulate Filter (DPF).

Besides empty and full, the gauge also indicates 1/4, 1/2, and 3/4 of total capacity. DEF fluid is required to meet certain emission requirements. A warning icon and popup message will appear when the DEF level is low. Do not allow your DEF tank to remain empty. Please refer to your emission supplemental manual for more details about DEF fluid.

i NOTE

The instrument cluster gauges may appear, if hidden from view, change brightness and change color to bring attention to a particular system.

Fuel Level

Fuel Level Gauge

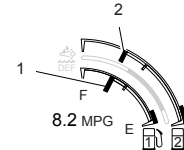

The Fuel gauge(s) indicate the fuel level.

⚠ WARNING

DO NOT carry additional fuel containers in your vehicle. Fuel containers, either full or empty, may leak, explode, and cause or feed a fire. Failure to comply may result in death or personal injury.

**WARNING**

Diesel fuel in the presence of an ignition source could cause an explosion. A mixture of gasoline or alcohol with diesel fuel increases this risk of explosion. DO NOT remove a fuel tank cap near an open flame. Use only the fuel and/or additives recommended for your engine. Failure to comply may result in death, personal injury, equipment or property damage.

**CAUTION**

Use only Ultra Low Sulfur Diesel (ULSD) Fuel, as recommended by engine manufacturers. If you need further information on fuel specifications, consult the Engine Operation and Maintenance Manual.

**NOTE**

For Export vehicles, the fuel gauges will not state: ULTRA LOW SULFUR DIESEL FUEL ONLY.

**NOTE**

This vehicle may be manufactured with different fuel systems and different draw tube locations. Because of this and the amount of road crown, it is recommended that you do not operate your vehicle with less than one-quarter of your truck's fuel capacity. Allowing the fuel level to go below one-quarter of capacity could result in the lack of fuel to keep the engine running. In addition, you will want to keep the fuel tanks at least half-full to reduce condensation of moisture in the tanks. This moisture can damage the engine.

**NOTE**

The instrument cluster gauges may appear, if hidden from view, change brightness and change color to bring attention to a particular system.

Favorites View (optional)

Vehicles with Favorites View will allow the operator to customize the arrangement of many of the gauges. Using the Favorites View requires the operator to **Scroll** to select the Minimized View. Once the Minimized view is showing, **Scroll** up once more to the star icon the View Indicator. See [Favorites](#) on page 66 to customize the Favorites view.

Configure Settings

Menu Example: main Menu

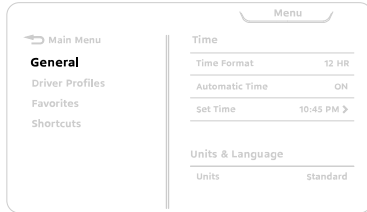

The following Menus

- Notifications
- Trip Summary
- Settings
- Truck Information

are accessible when

1. The Parking Brake is set
2. All active popup messages are viewed and suppressed
3. Press the **Select** button

These menus allow the operator to configure settings on the vehicle.

Notifications

Notifications display system messages related to the condition of your vehicle. It displays

- Tire Pressure Monitoring System (TPMS) (optional)
- Active messages
- Systems Check

Trip Summary

Presents a summary of details such as fuel economy and distance of the trip, collected during the main trip and/or Sub-trips. These details will be collected until the Trip is reset, or the max trip distance (99,999.9 miles for main, 9,999.9 for Sub-Trips) is reached.

Settings

Settings allows the operator to customize the Display.¹

General

Time

This menu allows the operator to customize the clock.

Automatic Time (optional) When enabled, trucks with Automatic Time will receive time zone appropriate data.

24-Hour Time Choose between 12 or a 24 hour format. AM or PM (A or P) shall only be displayed in 12-hour time format.

Set Time Set Time is available when Automatic Time isn't enabled. Set the clock to indicate your local time.

Units and Language

Units

Use this setting to change the units of measurement between Standard, Metric (Bar), and Metric (PSI).

Language

Use this setting to change the language.

Features

Features allows the operator to enable optional features on the vehicle to customize their experience.

Predictive Cruise Overshoot

Configure the Predictive Cruise Control Overshoot through this menu item. See [Predictive Cruise Control \(Option\)](#) on page

¹ If Anti-Theft is enabled, Settings will not be accessible until the correct Passcode is entered.

129 for more details about Overshoot and Predictive Cruise Control.

LVD Setup

Change the LVD battery voltage set point for LVD to turn on [Low Voltage Disconnect \(LVD\) \(option\)](#) on page 234.

Trailer Detection (Option)

The trailer outputs on your vehicle will detect a connected trailer when this feature is enabled. The operator will be notified when a trailer connection is not detected.

Digital RPM (optional)

Provides a digital numeric readout of the engine speed in the speedometer.

Windshield Wiper Interlock

This activates the headlights when the windshield wipers are turned on.

Dark Cabin

Dark Cabin prevents cab interior lights from turning on when a cab door is opened.

Shutdown Timer



WARNING

Never idle your vehicle for prolonged periods of time if you sense that exhaust fumes are entering the cab. Investigate the cause of the fumes and correct it as soon as possible. If the vehicle must be driven under these conditions, drive only with the windows open. Failure to repair the source of the exhaust fumes may result in death, personal injury, equipment or property damage.



CAUTION

DO NOT allow your engine to idle, at low rpm (400-600 rpm), longer than five minutes. Long periods of idling after the engine has reached operating temperatures can decrease engine temperature and cause gummed piston rings, clogged injectors, and possible engine damage from lack of lubrication. The normal torsional vibrations

generated can also cause transmission wear.



CAUTION

Do not stay in the vehicle with the engine running or idling for more than 10 minutes with the vehicle's Heater and A/C ventilation system in RECIRC or at LOW FAN SPEED. Even with the ventilation system on, running the engine while parked or stopped for prolonged periods of time is not recommended.



CAUTION

Prolonged periods of idling can result in lower than optimal engine/transmission operating temperatures which could cause increased rates of wear. An idle shutdown feature (available on PACCAR engines) can be programmed to shut the engine down after a period of low idle operation with no driver activity. A flashing warning lamp will inform the driver of an impending shutdown. Failure to comply may result in equipment or property damage.



NOTE

If you are required to idle your vehicle for long periods of time, install an auxiliary heater or automatic idle control. These auxiliary devices can reduce fuel consumption and save you money.

When active, the Shutdown Timer will keep the engine running for a period of time after

the ignition switch is placed in the OFF position. This allows the driver to exit the cab while sustaining power to the cab interior. Normally, this would require the key to remain in the ignition, potentially leaving the cab unlocked and accessible. When the timer reaches zero, the engine stops, removing power from certain electrical loads. The timer counts down in the Drive Summary.

The Shutdown Timer is enabled or disabled in the Display menu and can be set for up to 30 minutes. This setting can be changed in the Settings Sub-menu or while counting down, in the Drive Summary, using the Scroll and Select (See [How to Set the Shutdown Timer](#) on page 131). The Shutdown Timer setting may be limited to less than 30 minutes (See [Greenhouse Gas Certified Configuration](#) on page 291).

If your truck has the Engine Idle Shutdown Timer (EIST) option and it is set for a shorter shutdown time, the Engine will shutdown at the shorter timer setting.

Driver Profiles

This feature saves customizations made as a Driver Profile. Turning Driver Profiles ON

for the first time will load current customizations into Driver Profile 1 and make it the active profile. The profile can be changed in this menu.

The active Driver Profile can also be changed after setting the park brake and then pressing **Back**.² Changes to Driver Profile will be auto-saved while making customizations. They will not be lost when turning the feature off.



NOTE

The last used active profile, including any changes to that profile, will remain the profile until a new one is selected.

Choosing the Active Driver Profile

Press **Back** when the parking brake is set to change the active Driver Profile.

Favorites

To disable Favorites, contact your authorized dealer. Vehicles with Favorites View enabled allow the operator to create a customized arrangement of all but centrally located gauges. To change the

² The ignition key may need to be cycled back to OFF and then ON to access the Driver Profiles Settings.

Favorites configuration, stop the truck, set the parking brake and

- Access Favorites via the Settings Sub-menu. OR
- **Scroll** to Favorites (represented by a star in the View Indicator) and press **Select**.

Adding a Gauge to Favorites

The truck must have the Parking Brake set to add a gauge. You must be in the Edit Your Favorites menu to perform this procedure.

Adding a gauge requires that the gauge is not already assigned a location in Favorites View. If you want to move a gauge already assigned, you must first remove that gauge [Removing a Gauge from Favorites](#) on page 68.

1. **Scroll** the list until you locate the desired gauge or compound gauge.

Edit Your Favorites (Center of Screen)

Continue editing Favorites or save configuration

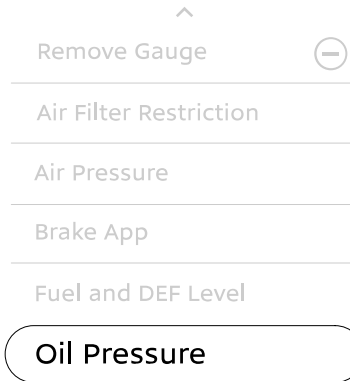

If the gauge you want to position is already present in the Favorites View (either as a single or compound gauge) it will not appear as a menu option.

2. **Select** to choose the gauge you want to position.
3. **Scroll** through the valid locations (this can include positions currently

holding a gauge, which may be replaced) and target that position.

If a position is not valid, the display will read "Not Available."

Edit Your Favorites (Left-side of image)

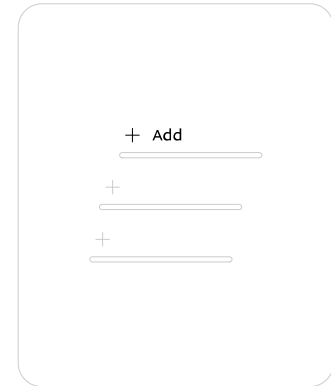

4. **Select** to Add or Replace the gauge.

Navigate and **Select** "Save Configuration" when all gauges have been arranged. The Display will read "Your favorites configuration has been saved." Press **Back** to exit Editing Favorites.

Removing a Gauge from Favorites

The Parking Brake must be set and at least one gauge must be in the Favorites View to remove a gauge.

The Speedometer/Tachometer, Fuel, and Air pressure gauges located at the Display center cannot be removed. If the gauge you want to remove is part of a multiple gauge group, the whole group must be removed.

1. **Select** "Remove Gauge."
2. **Scroll** to highlight the gauge to be removed and **Select**.

Navigate and **Select** "Save Configuration" if this is the last change you want to make to Favorites View. The Display will read "Your favorites configuration has been saved." Press **Back** to exit Editing Favorites.

Shortcuts

Use the Shortcuts option to assign one of the following features to the **Shortcut** button.

- Dark Cabin – Toggles Dark Cabin On/Off.
- Digital RPM – Provides a numeric read-out of RPM within the speedometer.

- Dual Speedometer – Shows a compound Speedometer with both Standard and Metric Values. .
- Favorites – Selects the Favorites View on the Display.
- Metric Units – Switches all measured units used on the Display between Standard and Metric.

Anti-Theft

Anti-Theft prevents starting the engine and accessing the settings sub-menu. If Anti-Theft does not show in the settings sub-menu, see your authorized dealer to install Anti-Theft.

If Anti-Theft is enabled, turning the ignition switch to START prompts the operator to enter the passcode. Once the correct passcode is entered, you have five minutes to start the engine or the passcode must be re-entered.³

To enable or disable Anti-Theft, change Anti-Theft (ON/OFF) in the settings sub-menu and enter the current passcode.

How to Enter the Passcode

The ignition key and the current Passcode are required.

The default passcode is set to 0000 at the factory. Please see an authorized dealer if a custom passcode is needed. With the anti-theft feature turned off, the operator will not need a passcode to start the engine.

1. Using the **Scroll** , scroll to the first number in the code then press **Select**.

Anti-theft first digit

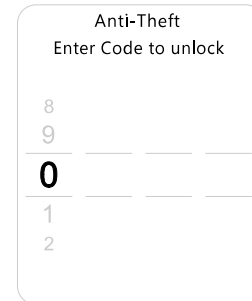

The next digit will be selected.

³ The five minute timer can be postponed in one minute intervals using any steering wheel switch.

2. **Scroll** to the number you want for this digit and press **Select**. The next digit will be selected.
3. Continue this process until all four digits have been chosen.

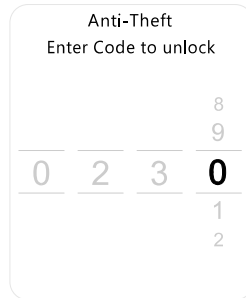
Anti-theft last digit

The display will read "Turn Key to Start Engine."

Truck Information

Truck information stores specifications and data about the vehicle.

- Chassis
- Engine
- Anti-lock Brake System

- Transmission
- GHG Vehicle Speed Limits
- Remote Station Interlocks
- Predictive Cruise Control option
- Adaptive Cruise Control (ACC) option
- Power Take Off (PTO) option

Information specific to these categories will be shown in the Truck Information Sub-menu.

Drive Summary

The Drive Summary presents information about the most recent leg of travel and is shown when the ignition key is turned to "off." The Drive Summary consists of

- Critical and Non-critical Issues (see [Systems Check](#))
- Shut Down Timer (if active) (see [Shut Down Timer](#))
- TPMS (option) (see [Tire Pressure Monitoring System \(TPMS\) \(option\)](#) on page 30)
- Driver Rewards (option) (see [Driver Rewards](#))
- Driver Performance Assistant (option) (see [DPA](#))

- Three customer-selected reports (i.e. Idle Time, Fuel Economy)

The Drive Summary collects information since the last time the engine was off for at least two hours. When insufficient information has been collected, Drive Summary will show dashes for the monitored component or report. Customer-selected reports can be changed at your local dealership.

Driver Rewards (option)

If enabled, Driver Rewards raises or lowers the vehicle's max-allowable speed based on whether a programmed, fuel economy goal is met. This goal is defined by the customer and can be based on fuel consumption, engine idle time, or both fuel consumption and idle time. The driver is assigned a score based on how successfully they meet or exceed this goal. Driver Rewards is only available for vehicles equipped with a PACCAR MX engine.

The fuel consumption goal is met by reducing the amount of fuel used over a given distance. This is achieved by

- Driving slower

- Minimize Speed Changes
- Accelerating gently
- Coasting in gear
- Using the Cruise Control
- Maintaining optimal tire pressure.
- Reducing the trailer gap
- Running a Warmer Cab.
- Turning off extra electrical loads

The engine idle time goal is met by reducing the time the engine idles (running the engine when the vehicle is not in motion).

The Driver Rewards score is based on driving habits. This score is compared to the goal and a max-speed bonus or penalty is determined. The Driver Rewards score is shown during a Systems Check and in the Driver Summary. When there is a bonus or penalty, it appears below the Cruise Control (CC) indicator on the dash, and the max-allowed speed shows to the right of the CC indicator. Driving habits that reduce fuel use will earn the operator a higher max speed; habits that consume more fuel will lower the max speed. Driver Rewards will never grant a bonus that exceeds programmed federal emission regulated or customer defined speed limits. During the Systems Check, the Driver Rewards and DPA features offer general

driving tips that can increase fuel economy and brake savings. These features also provide feedback in the Driver Summary based on a driver's specific driving habits. This advice if followed can improve future Driver Rewards and DPA scores. Driver Rewards has three customer-determined modes of activation: only when CC is in use, when CC is not being used, or at all times. The Driver Rewards goal and the amount of penalty or bonus is also customer-determined and should be based on reasonable expectations for a known route of travel. The Driver Rewards goal should be reconsidered if the manner of vehicle use or the vehicle route changes significantly.

To enable or disable Driver Rewards, or change the mode of activation, reward amounts, or set a new Driver Rewards goal, contact your dealership.

Driver Performance Assistant (option)

If enabled, the Driver Performance Assistant (DPA) determines how skillfully the operator uses coasting and the engine brake when reducing vehicle speed.

Coasting and engine brake use, instead of frequent, aggressive use of the service brakes, can extend brake life and increase fuel economy. The DPA assigns the driver a score based on their braking habits and provides suggestions on how to improve these habits. The DPA feature is only available for vehicles equipped with a PACCAR MX engine.

The driver's DPA score is determined by comparing their braking and coasting habits against a customer-defined goal for braking use and coasting. A score that meets or exceeds this goal will award positive feedback in the Driver Summary. During the Systems Check, the DPA and Driver Rewards features offer general driving tips that can increase fuel economy and brake savings. These features also provide feedback in the Driver Summary based on a driver's specific driving habits. This advice if followed can improve future DPA and Driver Rewards scores (see Driver Rewards).

To enable or disable the DPA or set a new DPA goal, contact your dealership.

Bulb Check

When the ignition switch is turned ON multiple warning icons will be displayed in a sequence to test each warning light indicator. The total sequence should take no more than 10 seconds to complete. Have your instrumentation system checked by a qualified service technician if does not successfully complete.

Audible Alarm

The audible alarm will sound in conjunction with most warning lights. These events include but are not limited to headlight on, fifth wheel, stop engine, primary/secondary air, and driver door open warnings.

Optional Icons

Additional icons may be operational depending on individual vehicle specifications.



NOTE

Some optional lights may illuminate even though your vehicle is not equipped with that particular feature.

Physical Telltales

3

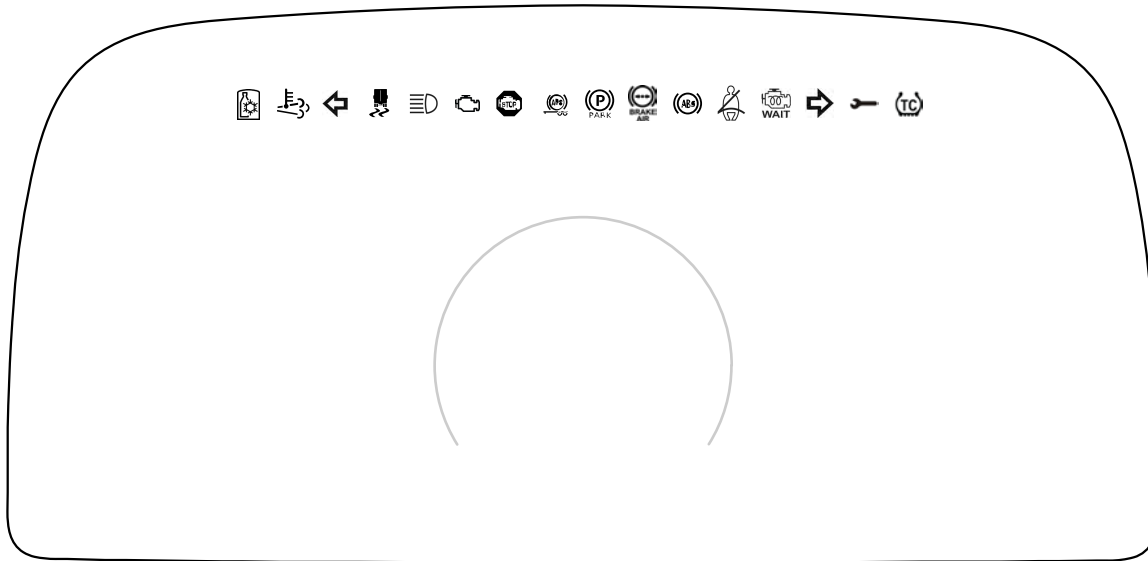

These physical telltales will always appear across the top of the display.

most signify that the monitored component requires operator attention.

Dedicated Telltales

Dedicated Telltales always appear in the same location throughout the screen. Some are visible only when active, but

Dynamic Telltales

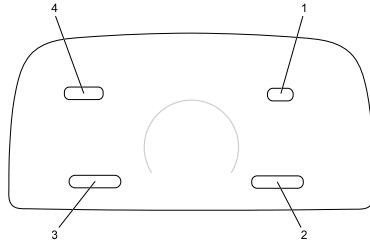

These dynamic telltales appear on the display in the rows indicated. A dynamic telltale communicates the status of a monitored component, which may require the operator to respond or take action.

Active Warnings

Red or amber popups are counted and the total is displayed by the active warning indicator. In addition, these counts are also presented in

- Systems Check
- The Notifications Sub-menu
- A Drive Summary

The numbers may change without user interaction if individual warnings are intermittent, time based, self correcting, or the situation is rectified.

Popups

Popup: Red Oil Temp



A Popup displays information from the vehicle computer. Certain types of popups are indicated by the Warning Indicator in the display area.

Multiple Popups will appear in the display as a stack of messages. Suppressible Popups are those that will move out of the stack when driving. All are suppressible when the Parking Brake is set.

The Menu will not be accessible until all Popups have been Suppressed.

Viewing and Suppressing Popups

A Popup can be read and Suppressed by pressing the Scroll Wheel. Some situations may require pressing **Back** instead. For example, the following image is suppressed by pressing the Scroll Wheel (noted with the arrow down) OR by pressing the **Back**(indicated with the X mark below the roller).

Suppressable Popup Message

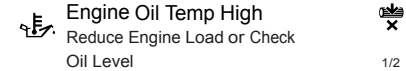

Guide to the Warning Symbols

The warning lamps and audible alarm may indicate a system malfunction. Check the lamps frequently, and respond promptly as soon as you see one go on. These lamps could save you from a serious accident. Additionally, gauges may become visible, may change colors, or may change brightness to raise awareness to the operator.

When multiple warning symbols are shown on the instrument cluster, they will appear at first and then minimize. When minimized they will be represented in the active warnings area of the display. A triangle represents a warning registered and a diamond represents a check message.



WARNING

DO NOT ignore a warning lamp or audible alarm. These signals tell you something is wrong with your vehicle. It could be a failure in an important system, such as the brakes, which

could lead to an accident causing death or injury. Have the appropriate system checked immediately.

Check messages are provided to give the operator additional information regarding systems that require attention due to a system malfunction and/or operating conditions that may hinder safe and proper performance of the vehicle. The system will

emit a chime to alert the operator that a message is appearing on the cluster. Some messages can be managed by the operator while others may require an authorized dealer repair. In the following table is a list of warning lamp/indicator symbols that appear in the instrument cluster. Each symbol has a unique name, color when illuminated, and whether the symbol is standard (Std) or optional (Opt).

Symbol Name	Color	Standard or Optional
<i>Axle, Stability Control (Option)</i> on page 76	Yellow	STD
<i>Axle, Traction Control</i> on page 77	Yellow	STD
<i>Brakes, Antilock Brake System</i> on page 77	Yellow	STD
<i>Brakes, Low Air</i> on page 78	Red	STD
<i>Brake, Park Brake</i> on page 78	Red	STD
<i>Brakes, Trailer Antilock Brake System</i> on page 78	Yellow	STD
Cab, Door Ajar	Amber	STD
<i>Differential, Inter-Axle Lock</i> on page 79	Yellow	OPT
<i>Dump Truck, Body Up</i> on page 79	Red	OPT
<i>Dump Truck, Gate</i> on page 79	Yellow	OPT

Symbol Name	Color	Standard or Optional
<i>Diesel Particulate Filter (DPF) Warning Light</i> on page 79	Yellow	STD
Emissions, Derate	Amber	STD
<i>Emissions, High Exhaust System Temperature</i> on page 79	Yellow	STD
<i>Emissions, Malfunction Indicator Light</i> on page 80	Yellow	STD
<i>Engine, Check Engine</i> on page 80	Yellow	STD
<i>Engine, Engine Block Heater</i> on page 80	Yellow	OPT
<i>Engine, Low Coolant Level</i> on page 80	Yellow	STD
<i>Engine, Overspeed Air Shutdown</i> on page 80	Red	OPT
<i>Engine, Retarder (Brake)</i> on page 80	Green	OPT
<i>Engine, Stop Engine</i> on page 81	Red	STD
<i>Engine Wait-to-Start Light</i> on page 81	Yellow	OPT
<i>Fifth Wheel Slide Unlocked</i> on page 81	Red	OPT
<i>Fifth Wheel Locked</i> on page 82	Red	OPT
<i>Fifth Wheel Unlocked</i> on page 82	Red	OPT
<i>Lane Departure Warning (LDW)</i> on page 82	Yellow	OPT
<i>Lights, High Beam</i> on page 82	Blue	STD
<i>Fast Idle Control</i> on page 82	Yellow	OPT

Symbol Name	Color	Standard or Optional
<i>Refrigerator</i> on page 83	Green	OPT
Seat Belt Fasten	Red	STD
Suspension, Lift Axle	White	OPT
<i>Tire Inflation (TPMS)</i> on page 83	Yellow	OPT
<i>Transmission, Auxiliary</i> on page 83	Yellow	OPT
<i>Transmission, Check</i> on page 83	Red	OPT
<i>Turn Signal, Left</i> on page 83	Green	STD
<i>Turn Signal, Right</i> on page 83	Green	STD

Axle, Stability Control (Option)

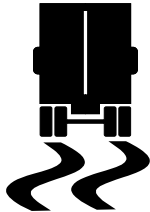

Calculates the driver's intended path of travel from wheel speed and steering angle sensors, then compares calculations to the

actual direction of travel. The system uses individual wheel brakes to re-adjust the path of the vehicle.

- The Stability Control Icon (ESC or Electronic Stability Control) illuminates during the Bulb Check when the ignition is turned ON. It turns off after a few seconds if no system problems are detected. If a problem is detected, the ESC Warning lamp will turn on and stay on.
- Illuminates when the ESC system is regulating individual wheel

brakes to correct the vehicle's direction of travel. (Refer to Advanced ABS with Stability Control for more information.)

**WARNING**

If this chassis is equipped with an Electronic Stability Control (ESC) and is modified (e.g. adding or removing an axle, converting from a truck to a tractor, converting from a tractor to a truck, changing the body, lengthening of the wheelbase and/or frame, relocating frame components, or modifying pneumatic or electrical ABS/ESC harnesses) the ESC must be evaluated by a qualified technician. If you have any questions, contact your authorized dealer. Failure to comply may result in property damage, personal injury, or death.

**NOTE**

For more information about the stability control system installed on your vehicle, please refer to additional material supplied with this operator manual, included in your glove box informational packet.

Axle, Traction Control

Monitors wheel speed for poor traction. If a wheel begins to slip due to poor traction, it may reduce engine power or apply brakes in an effort to regain traction.

- Illuminates during the Bulb Check when the ignition is turned ON. It turns off after a few seconds if no system problems are detected. If an ATC problem is detected, the ATC warning light will turn on and stay on.
- Illuminates when the ATC is regulating wheel spin and turns off after the traction control event has ended.
- Flashes continuously when the ATC/Deep Snow & Mud switch is turned on, indicating that this feature is active.

**WARNING**

If this chassis is equipped with an Electronic Stability Control (ESC) and

is modified (e.g. adding or removing an axle, converting from a truck to a tractor, converting from a tractor to a truck, changing the body, lengthening of the wheelbase and/or frame, relocating frame components, or modifying pneumatic or electrical ABS/ESC harnesses) the ESC must be evaluated by a qualified technician. If you have any questions, contact your authorized dealer. Failure to comply may result in property damage, personal injury, or death.

**NOTE**

For more information about the stability control system installed on your vehicle, please refer to additional material supplied with this operator manual, included in your glove box informational packet.

Brakes, Antilock Brake System

Illuminates during the bulb check. Have the ABS system checked by an authorized dealer if the ABS Warning Lamp stays on for more than 3 seconds.

- Illuminates during normal operating conditions to indicate a problem with the ABS system.
- Illuminates when a problem exists with Automatic Traction Control (ATC).

Brake, Park Brake



Illuminates in the status indicator when parking brakes are applied.

Brakes, Low Air



Illuminates when system air pressure falls below 60 psi.

Brakes, Trailer Antilock Brake System

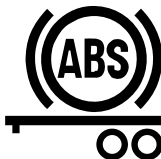

Illuminates during the bulb check and the tractor/truck is connected with a ABS equipped trailer. Illuminates during normal operating conditions to indicate a problem with the Trailer ABS System. This should be checked by an authorized dealer as soon as possible.



NOTE

Tractors/Trucks and trailers built after 03/01/2001 must be able to turn on an In-Cab Trailer ABS Warning Light (per U.S. FMVSS121). The industry chose Power Line Communication (PLC) as the standard method to turn it on. On trailers built prior to 03/01/2001 verify

trailer ABS system status via the required external warning light mounted on the trailer. The indicator light on the trailer should be yellow and identified with the letters ABS.

Cruise Control



This indicator shows the operator which Cruise Control function is currently enabled or active. This includes

- Cruise Control
- Adaptive Cruise Control (optional)
- Predictive Cruise Control (optional)
- Variable Road Speed Limiter (optional)

When a Cruise Control function is enabled, a white indicator will appear. When a Cruise Control function has been activated, the indicator will change from white to green. For more information on use of the various Cruise Control functions, see Cruise Control, Adaptive Cruise Control,

Predictive Cruise Control, and Variable Road Speed Limiter.

Differential, Inter-Axle Lock



Illuminates when the inter-axle differential switch is ON thus locking the inter-axle differential. This powers the forward rear and the rear rear differentials equally. When the switch is turned off (inter-axle differential unlocked) the engine power is allowed to flow to any of the four drive tires based on the differential effect (mostly to the forward rear differential). This feature is standard on all tandem axles.

	NOTE
<p>Tractors/Trucks and trailers built after 03/01/2001 must be able to turn on an In-Cab Trailer ABS Warning Light (per U.S. FMVSS121). The industry chose Power Line Communication (PLC) as the standard method to turn it on. On trailers built prior to 03/01/2001 verify trailer ABS system status via the re-</p>	

quired external warning light mounted on the trailer. The indicator light on the trailer should be yellow and identified with the letters ABS.

Dump Truck, Body Up



Illuminates when Truck Dump Body is up.

Dump Truck, Gate



Illuminates when Truck Dump gate is open.

Diesel Particulate Filter (DPF) Warning Light

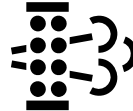

This icon and related message will appear when the DPF needs to be regenerated and then also during the regeneration cycle. This may also appear if the system

is attempting to automatically regenerate while the vehicle is in Power Take Off operation mode. Engine aftertreatment system includes a diesel particulate filter and DPF warning light.

Emissions, High Exhaust System Temperature



	WARNING
<p>If this light is on, do not park in an area of combustible vapors or materials. You must keep combustibles at least 5 ft. (1.5 m) away from the exhaust (outlet) stream as it exits the tail pipe while the HEST light is illuminated. Always park your vehicle outside. Failure to do so could ignite an explosion or harm bystanders which could result in serious injury.</p>	



WARNING

If this lamp is on, do not park in an area where people are close by. You must keep combustibles at least 5 ft. (1.5 m) away from the exhaust outlet while the HEST lamp is illuminated. Failure to do so could result in serious injury.



WARNING

If this lamp is on, temperature of the tailpipe, exhaust pipes, the diesel particulate filter (DPF)/selective catalytic reduction (SCR) device and surrounding components including enclosures and steps becomes elevated during engine operation or any regeneration event and can cause serious burns to the skin. Allow adequate cooling time before approaching, working on or near any part of the exhaust system or surrounding components.

Illuminates when the exhaust gas temperature and exhaust components become extremely hot.

Emissions, Malfunction Indicator Light



Illuminates when an engine emissions failure has occurred. The vehicle can be safely driven but should be serviced to correct the problem. The situation should not be considered an emergency. In some cases, the Malfunction Indicator Light will activate in conjunction with the High Exhaust Temperature, Diesel Particulate Filter (DPF), and Diesel Exhaust Fluid (DEF) Warning Lights.

Engine, Check Engine



Illuminates when a non emissions related problem exists, but the vehicle can still be safely driven. Vehicle should be serviced to correct the problem but the situation should not be considered an emergency.

Engine, Engine Block Heater



Illuminates when the engine block heater is turned on.

Engine, Low Coolant Level



Illuminates with an audible alarm indicating critically low coolant level. The vehicle must be serviced to correct the problem but the situation should not be considered an emergency.

Engine, Overspeed Air Shutdown



Illuminates when the Engine overspeed air shutdown system is activated.

Engine, Retarder (Brake)



Illuminates when the engine retarder (compression brake or exhaust brake) switch is turned on.

Engine, Stop Engine



Illuminates and an audible alarm tone will sound when a major engine system problem exists.

 WARNING
<p>If the Stop Engine warning light illuminates, it means you have a serious engine system problem. This should be considered an emergency. You should stop the vehicle as safely as possible and turn OFF the ignition. The vehicle must be serviced and the problem corrected before driving again. Failure to</p>

comply may result in death, personal injury, equipment or property damage.

Engine Wait-to-Start Light

This warning icon will appear when the system needs some time before attempting to start the engine. The light will illuminate at key ON, and will stay on for a period of up to 30 seconds.



 NOTE
<p>The length of time the 'Wait-To-Start' lamp remains illuminated depends on the ambient temperature. The lower the ambient temperature, the longer the lamp will be illuminated.</p>

Once the Wait-to-Start light turns off, turn the key to the starting position to start the engine. You may see this appear if the system has detected a situation where the starter is too hot and needs to cool down. Alternatively,

you may see it when the engine grid heater is on and needs some time to warm up.

 NOTE
<p>Some engines are equipped with an engine starting motor protection feature. If the starting motor is engaged for 30 or more seconds, without the engine starting, the starter will be locked out from operating, allowing for proper cooling of the starting motor. During this time, the 'Wait-To-Start' lamp will flash for 2 minutes. Once the lamp stops flashing, the starting motor will be allowed to function.</p>

Emissions, Engine Derate



Fifth Wheel Slide Unlocked



Illuminates when fifth wheel slide switch is activated. Indicates fifth wheel can move.



WARNING

DO NOT move the fifth wheel while the tractor-trailer is in motion. Your load could shift suddenly, causing you to lose control of the vehicle. Never operate the vehicle with the switch in the UNLOCK position. Always inspect the fifth wheel after you lock the switch to be sure the fifth wheel slide lock is engaged. Failure to comply may result in death, personal injury, equipment or property damage.



NOTE

Vehicles having an air slide fifth wheel have a fifth wheel slider lock controlled by a switch on the instrument panel. By placing the switch in the unlock position you can slide the fifth wheel to various positions to adjust weight distribution.

Fifth Wheel Locked



Illuminates when the fifth wheel is in the locked position.

Fifth Wheel Unlocked



Illuminates when the fifth wheel is in the unlocked position. Indicates the king pin is disengaged.

Lights, High Beam



Illuminates when the high beams are on. This icon will flash with audible alarm if the headlights are left ON when the door is opened and the key switch is OFF.

In addition, this icon will flash, but without an audible alarm, if there is a problem with the low beam headlights or the low beam headlight wiring. In such event, the high beam headlights will turn on at 50% normal brightness.

Lane Departure Warning (LDW)



Illuminates when LDW system is not able to track the vehicle's position within the lane.



NOTE

For vehicles equipped with Lane Departure Warning, please refer to Lane Departure Warning Driver's Guide for additional information.

Fast Idle Control

The display will show the Fast Idle Control (FIC) indicator when enabled or activated. The indicator shows the set RPM value. See [Indicators around the speedometer](#) on page 121.

Refrigerator

Illuminates to indicate that the refrigerator is on and ignition is off.

Seat Belt Fasten

Illuminates when the ignition key is turned on as a reminder to fasten your seat belt.

Tire Inflation (TPMS)

Illuminates when tire pressures need to be checked.

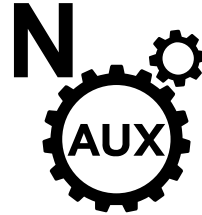
Transmission, Auxiliary

Illuminates to indicate auxiliary transmission is in neutral.

Transmission, Check

Illuminates when transmission has recorded a fault code.

Turn Signal, Left

Blinks when the left turn signal or the hazard light function is operating.

Turn Signal, Right

Blinks when the right turn signal or the hazard light function is operating.

Optional Gauges

For vehicles with a telematic navigation screen, optional gauges will be part of the screen functions. Please refer to the navigation system supplement for further details about its functions and how it works. Some vehicles may have optional analog gauges installed at the factory in place of the navigation screen.

Manifold Pressure Gauge

This gauge indicates the pressure in the intake manifold. The pressure in the manifold is directly related to the turbo output and is related to the engine power output.



If the pressure indicated by your manifold pressure gauge goes down, there may be something wrong with your engine. Have it checked by a qualified service person.

Drive Axle Temperature Gauge (Forward and Rear)



These gauges indicate the temperature of the lubricant in your vehicle's axle(s). These temperatures will vary with the kind of load you are carrying and the driving

conditions you encounter. Maximum axle temperature may vary, depending upon the axle and type of lubricant. Very high temperatures signal a need to have your axle lubrication checked.

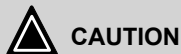

CAUTION
Driving with very hot temperatures in your rear drive axles can cause serious damage to axle bearings and seals. Have your axle lubrication checked if you notice a sign of overheating.

Depending on the vehicle configuration, there may be a single gauge for more than just the forward and rear driver. The icon will have an "X" over the representative

axle to indicate which axle's temperature is being displayed in the gauge.

Dash Switches

This custom vehicle will have a wide variety of switch-controlled equipment. However, this particular vehicle may not have every switch identified in this section of the operator manual. Some air device switches on the dash may require that the vehicle either be at a specific speed, have park brakes set, or another device to be on or off for the air device to operate. The instrument display will show information regarding what needs to change in order for the air device to operate as expected. The following table provides a complete list of icons that may be found on the switch.

Title	Standard or Optional
Axle, Differential Lock - Tridrive	OPT
Axle, Diff-Lock - Dual	OPT
Axle, Diff-Lock - Forward Rear	OPT
Axle, Diff-Lock - Rear Rear	OPT
Axle, Diff-Lock - Single Rear	OPT

Title	Standard or Optional
Axle, Diff-Lock - Steer	OPT
Axle, Inter-Axle Differential Locked (Tandem)	OPT
Axle, Two Speed	OPT
Back Up Alarm Mute	OPT
Batteries, Low Voltage Disconnect (LVD)	STD
Brakes, ABS Off-Road	OPT
Brakes, Parking Brake Valve	STD
Brake, Trailer Hand	STD
Cab Dimmer Switch	STD
Dump Truck Gate	OPT
Engine, Fan Override	OPT
Engine, Heater	OPT
Engine, Overspeed Air Shutdown (Test)	OPT
Engine, Overspeed Air Shutdown (Manual)	OPT
Engine, Remote Throttle	OPT
Engine, Under Hood Air Intake	OPT
Exhaust, Diesel Particulate Filter (DPF) Regeneration	STD
Fifth Wheel Slide	OPT

Title	Standard or Optional
Fuel Heater	OPT
Generic Air, Accessory	OPT
Generic, Spare	OPT
Ignition Key Switch	STD
Lane Departure Warning Disable	OPT
Lights, Auto Headlamp	STD
Lights, Auxiliary	OPT
Lights, Beacon	OPT
Lights, Daytime Running (Override)	OPT
Lights, Dome	STD
Lights, Exterior Lights Self Test	STD
Lights, Flood	OPT
Lights, Flood ISO 3732 Spare	OPT
Lights, Fog	OPT
Lights, Hazard	STD
Lights, Headlight and Parking Lights	STD
Lights, Marker/Clearance/Cab	STD
Lights, Marker/Clearance/Trailer	OPT

Title	Standard or Optional
Lights, Park Light	STD
Lights, Spot	OPT
Mud and Snow Traction Control	STD
Pintle Hook	OPT
Power Take-off (PTO)	OPT
Power Take-off (PTO), Forward	OPT
Power Take-off (PTO), Rear	OPT
Suspension, Air Retention	OPT
Suspension, Axle, Pusher	OPT
Suspension, Axle, Tag	OPT
Suspension, Dump	OPT
Suspension, Third Axle Lift	OPT
Trailer Air Supply	STD
Trailer, Axle (3rd Axle) Lift	OPT
Trailer, Axle Lift Forward	OPT
Trailer, Axle Lift Rear	OPT
Trailer, Belly Dump	OPT
Trailer, Belly Dump Gate Center	OPT

Title	Standard or Optional
Trailer, Belly Dump Gate Front	OPT
Trailer, Belly Dump Gate Rear	OPT
Trailer, Dump Gate	OPT
Trailer, Hotline	OPT
Trailer, Suspension Air Dump	OPT
Transmission, Transfer Case	OPT
Transmission, Transfer Case Two-Speed	OPT
Winch Clutch	OPT

Axle, Diff-Lock - Dual



Turn switch on to engage Front and Rear Axle Diff Lock.

Axle, Diff-Lock - Forward Rear



Turn switch on to engage Forward Rear Axle Diff Lock.

Axle, Diff-Lock - Steer



Turn switch on to engage Front Axle Diff Lock.

Axle, Diff-Lock - Rear Rear



Turn switch on to engage Rear Rear Axle Diff Lock.

Axle, Diff-Lock - Single Rear



Turn switch on to engage Single Rear Axle Diff Lock.

Axle, Inter-Axle Differential Locked (Tandem)



Turn switch on to engage Inter-Axle Differential Lock.

Axle, Differential Lock - Tridrive



Tridrives will have these axle differential lock controls and are 2 separate switches. **FRONT** will control the forward rear and **REAR** will control the center/rear-rear axle differential. In addition, a vehicle with Tridrive will have an interaxle differential lock switch.

Axle, Two Speed



If equipped, the two speed axle switch allows you to select axle high and low ranges. The low range (Off) provides maximum torque for operating off-highway.

The high range (On) is a faster ratio for highway speeds.

Back Up Alarm Mute



Turn switch on to mute Back Up Alarm.



The mute function use is discouraged. Only use mute when legally required.

Batteries, Low Voltage Disconnect (LVD)



If your vehicle is equipped with a Low Voltage Disconnect (LVD) feature, the LVD is integrated into the main load center.

Brakes, ABS Off-Road



Turn switch on to engage ABS Off-Road mode.

Brakes, Parking Brake Valve



Pull yellow knob to activate parking brakes.

Brake, Trailer Hand



This dash mounted switch provides air pressure to apply the trailer brakes only. It operates independently of the foot treadle valve.

Cab Dimmer Switch



This switch is used to alter the brightness of the instrument panel lights.

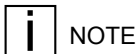

NOTE

The Headlight Switch is an ON or OFF switch. The panel lights are on full intensity during the day and dim when headlights are on.

Dump Truck Gate



Turn switch on to open Dump Truck Gate.

Engine, Fan Override



The optional engine fan switch allows you to control the engine fan manually or automatically.

Engine, Heater



Turn switch on to activate the Engine Heater.

Engine, Remote Throttle PUMP MODE

Turn switch on to activate Remote Throttle Control.

Engine, Overspeed Air Shutdown (Manual)

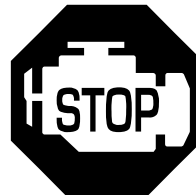

Turn switch on to engage the Engine Overspeed Air Shutdown system. A system reset will be required before re-starting engine. See EOAS system manufacturer's instruction manual for details.

Engine, Overspeed Air Shutdown (Test)



Hold down switch and increase engine RPM to test that Engine Overspeed Air Shutdown system functions correctly. A system reset will be required before restarting engine. See EOAS system manufacturer's instruction manual for details.

Exhaust, Diesel Particulate Filter (DPF) Regeneration

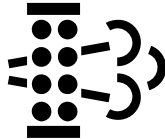

Manually controls the diesel particulate filter (DPF) regeneration process. Refer to Engine Aftertreatment Controls Operator's Manual for additional information.

Fifth Wheel Slide



Turn switch on to unlock Fifth Wheel Slide mechanism. The switch is guarded to protect you from accidentally activating or releasing the lock.

WARNING

DO NOT move the fifth wheel while the tractor-trailer is in motion. Your load could shift suddenly, causing you to lose control of the vehicle. Never operate the vehicle with the switch in the UNLOCK position. Always inspect the fifth wheel after you lock the switch to be sure the fifth wheel slide lock is engaged. Failure to comply may result in death, personal injury, equipment or property damage.

NOTE

Vehicles having an air slide fifth wheel have a fifth wheel slider lock controlled by a switch on the instrument panel.

By placing the switch in the unlock position you can slide the fifth wheel to various positions to adjust weight distribution.

Fuel Heater



Turn switch on to activate Fuel Heater.

Generic Air, Accessory



Provides accessory air to the end of the frame connection when switch is turned on.

NOTE

The generic air accessory switch is designed by the original equipment manufacturer to reset when the ignition power is turned off. When ignition is turned off, this circuit will exhaust air pressure.

Generic, Spare SPARE SPARE

Turn switch on to power customer installed accessory.

Ignition Key Switch

The ignition key switch located to the left of the steering column has four positions: ACC (Accessories), OFF, ON, and START. See also [Ignition Key Switch](#) on page 103.

Lane Departure Warning Disable



Vehicles equipped with this optional switch will disable the audible and visual Lane Departure Warning for 15 minutes after which time, or upon key cycle, the feature will re-enable. The feature may also be re-enabled by toggling the switch again while disabled. The switch will not affect any of the Adaptive Cruise Control warnings.

Lights, Auxiliary



Turn switch on for Auxiliary Lights.

Lights, Beacon



Turn switch on for Beacon Light(s).

Lights, Daytime Running (Override)



This switch overrides the normal operation of the Day Time Running Light (DRL) system. During normal operation, the DRL will turn on lights when the headlights are turned off, engine is on, and the park brakes are disengaged. The override switch will turn the DRL off in these

instances. The DRL is also turned off when the headlights are turned ON.



WARNING

DO NOT use daytime running lights (DRL) during periods of darkness or reduced visibility. DO NOT use DRL as a substitute for headlights or other lights during operations that require lighting of your vehicle. Failure to comply may result in personal injury, property damage or death.

If the headlight switch is turned OFF, the DRL system engages automatically after the engine starts and you release the parking brake. If the headlight switch is ON, the DRL system is overridden, and headlights operate normally. Also, the DRL is temporarily turned off during engine cranking.

Lights, Dome



Turn switch on for Cab Dome Lights.

Lights, Exterior lights Self Test

This switch will begin a sequence of turning on and off exterior lights so that the operator can verify functionality. See [Exterior Lighting Self-Test](#) on page 103.

Lights, Flood

Turn switch on for cab mounted Flood Lights.

Lights, Flood (Spare)

Turn switch on for trailer mounted Flood Lights.

Lights, Fog

Turn switch on for Fog Lights.

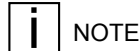

Across the U.S.A. and Canada, State/ Provincial requirements vary as to when high beams and fog lights can and cannot be used together. Some states allow only four lights to be used together, while some allow more. How your lights are arranged will affect whether you can operate headlights and fog lights concurrently always comply with the state or provincial requirements where you are driving.

Lights, Hazard

This switch operates the emergency flashers. With the switch in the ON position, the emergency flasher makes all four turn signals (front and rear) flash simultaneously. The flasher works independently of the ignition switch. You should always use the flasher if the vehicle is disabled or parked under emergency conditions.

**WARNING**

Use your Hazard Warning Light System any time you have to stop off the road or on the side of the road, day or night. A hard-to-see vehicle can result in an injury or accident. Another vehicle could run into you if you do not set your flashers and follow the placement of emergency signals per FMCSR 392.22.

Lights, Headlight

Turn switch for park/marker lights and headlights. When the headlights are ON, the dash lights, side, and tail lights are also

on. Headlights will turn on if the windshield wipers are turned on. Manually turning the headlights on and then off will override this function until the next time the vehicle is turned on.



CAUTION

If you have confirmed there is a problem in the low beam wiring circuit, proceed with caution to the next available exit/turnoff and safely pull your vehicle completely off the road and call for assistance. Driving your vehicle with the headlamps on high beam (at reduced intensity) for a prolonged period could lead to an injury accident. Contact your nearest dealer to have the problem corrected as soon as possible.

If the vehicle has LED headlights, the operator can turn on the mirror heat switch to heat up the lens of the headlights and remove any condensation.

3

Lights, Marker/Clearance



Turn switch on to control Cab and Vehicle Marker/Clearance lights.



NOTE

An interrupt switch for the trailer marker lights is mounted on the end of the turn signal lever.

Lights, Marker/Clearance/Trailer

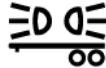

Turn switch on to control trailer marker/clearance lights separately from the vehicle marker/clearance lights.

Lights, Park Light



Turn switch on for Park Lights. When the Park Lights are on the dash lights, side and tail lights are also on.

Lights, Spot



Turn switch on for Spot Light.

Mud and Snow Traction Control



Momentarily push switch in to engage Traction Control (TC).

Pintle Hook





Turn switch on to remove the slack from the Tow Hook.

Power Take-off (PTO)



This vehicle may be equipped with a dash mounted switch that controls PTO engagement/disengagement. When the operator activates the switch for the PTO, the status indicator light (located on the switch) will immediately illuminate even though PTO engagement may not have occurred. If the PTO is engaged and the operator turns the switch OFF, the PTO status indicator light (located on the switch) will go out immediately even though PTO disengagement may not have occurred.

	NOTE
Actual PTO engagement/disengagement may be delayed momentarily since it is controlled by the air system and mechanical movement.	

	CAUTION
Increasing engine rpm before the PTO is actually engaged could prevent the PTO from engaging and/or cause PTO damage.	

Power Take-off (PTO), Forward



Your vehicle may be equipped with a dash mounted switch that controls forward PTO engagement/disengagement.

Power Take-off (PTO), Rear



Your vehicle may be equipped with a dash mounted switch that controls the rear PTO engagement/disengagement.

Suspension, Axle, Pusher



Turn switch on to lower Single or Forward Pusher Axle.

Suspension, Axle, Tag



Turn switch on to lower tag axle.

Suspension, Dump



Turn switch on to deflate suspension air bags. The switch is guarded to protect you from accidentally deflating the suspension.



WARNING

DO NOT operate the Air Suspension Deflate Switch (Dump Valve) while driving. Sudden deflation while your vehicle is moving can affect handling and control and could lead to an accident. Use this switch only when your vehicle is not moving.



CAUTION

Operating a vehicle with air suspension bags either overinflated or underinflated may cause damage to drive-line components. If a vehicle must be operated under such conditions, do not exceed 5 mph (8 km/h). Failure to comply may result in equipment damage.

3

Suspension, Air Retention

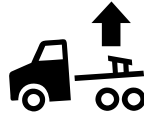

Suspension, Third Axle Lift



Turn switch on to raise Third Axle.

Trailer Air Supply



The red octagonal knob controls the air supply to the trailer.

Trailer, Axle (3rd Axle) Lift



Turn switch ON to lift 3rd Trailer Axle.

Trailer, Axle Lift Forward



Turn switch on to lift Forward Trailer Axle.

Trailer, Axle Lift Rear

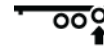

Turn switch on to lift Rear Trailer Axle.

Trailer, Belly Dump



Turn switch on to open Trailer Belly Dump.

Trailer, Dump Gate



Turn switch on to open Trailer Dump Gate.

Trailer, Belly Dump Gate Center

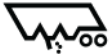

Turn switch on to open Trailer Center Belly Dump Gate.

Trailer, Belly Dump Gate Front



Turn switch on to open Trailer Front Belly Dump Gate.

Trailer, Belly Dump Gate Rear



Turn switch on to open Trailer Rear Belly Dump Gate.

Trailer, Hotline



Turn switch on to supply electrical power to trailer accessories.

Trailer, Suspension Air Dump

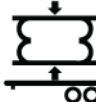

Turn switch on to deflate trailer air suspension.

Transmission, Transfer Case



Turn switch on to shift the transfer case.

Transmission, Transfer Case Two-Speed



Turn switch on to shift the two-speed transfer case.

Winch Clutch



Turn switch on to engage winch clutch.

Door Mounted Mirror Controls

If your vehicle is equipped with power mirrors, the mirror controls will be located on the driver-side door pad. Mirrors can be adjusted in four directions. To provide good visibility, adjust the mirror so the side of your vehicle appears in the inboard part of the mirror.

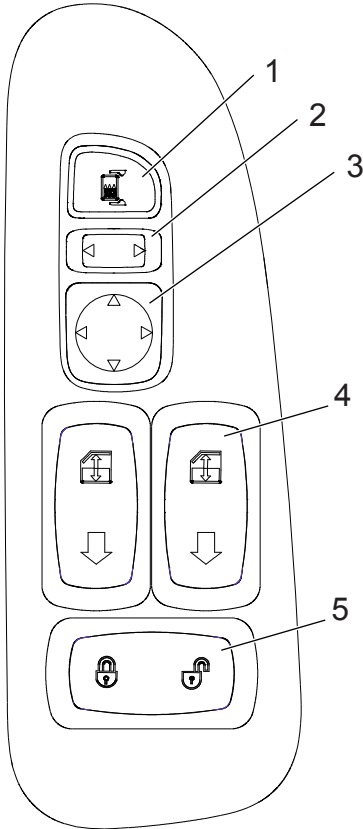

1. Mirror heat
2. Mirror adjust
3. Left or right mirror adjust selector
4. Window controls
5. Door lock control

Mirror Heat Switch

Your vehicle may be equipped with optional heated mirrors. Mirror heat is controlled by the mirror heat switch button. If the vehicle has optional hood-mounted heated mirrors, this switch will also activate heat to those mirrors. If the vehicle has optional LED headlights, this switch will also activate heat to those headlights.

Power Mirror Switch

If your vehicle is equipped with power mirrors, the directional controls for both mirrors are located near the top of the driver-side door trim pad.

Power Door Lock Switch

Power door lock rocker switches are located on the door pads. To lock or unlock both cab doors as well as a sleeper door, depress any door lock switch at the end that displays a closed or open padlock symbol, respectively, on the switch face.

Power Window Switch

Power window rocker switches are located on the door pads. Depress the switch to open the window or pull up on the switch to close the window. Release the switch to stop window movement. The driver-side window has an express down feature. Pushing on the switch all the way down until the switch bumps will activate the express down feature. Release the button and the window will continue to open until it is completely open.

Steering Column Controls

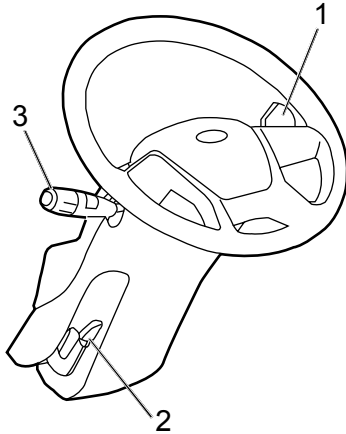

1. Engine brake (optional transmission shifter)
2. Tilt/telescope lever
3. Turn signal/wiper/lights

The turn signal lever is mounted on the left side of the steering column. The lever controls several functions: turn signal, high beam, and windshield wiper control. The turn signal lever will only operate when the key is in the ignition in the ACC position.

Tilt/Telescoping Steering Wheel

Depending on your vehicle's configuration, you may have either a tilt/telescoping feature.

- The tilt feature allows forward and rearward movement of the wheel.
- The telescoping feature allows you to move the wheel up and down.



WARNING

Make all adjustments to the steering mechanism while the vehicle is stopped. Adjusting the Tilt Telescoping Steering Wheel while the vehicle is in motion could cause loss of control. You would not be able to steer properly and could have an accident resulting in death or personal injury.

How to Adjust Tilt/Telescoping Steering Column



WARNING

Make all adjustments to the steering mechanism while the vehicle is stop-

ped. Adjusting the Tilt Telescoping Steering Wheel while the vehicle is in motion could cause loss of control. You would not be able to steer properly and could have an accident resulting in death or personal injury.

1. Push and hold the **Tilt Telescoping** lever down fully.
2. Push or pull the steering wheel to the desired height and angle.
3. Push the **Tilt Telescoping** lever back into the locked position.

How to Use the Turn Signal

The lever-action turn signal/high beam switch is located on the left side of the steering column. The ignition key must be turned to ON for the signal/switch to operate.

i NOTE

If the vehicle turn signals and turn signal indicators in the dash gauge cluster ever begin flashing at an accelerated rate (115 cycles per minute) when the turn signal lever is in the OFF (center) position, or when a Right/Left turn has been selected, the problem may be related to a failed turn signal switch or turn signal module. In either case, the problem is not a failed bulb. Contact your nearest authorized dealer to have the problem corrected as soon as possible.

1. Push the **Signal stalk** lever up to engage the RIGHT turn signal and down to engage the LEFT turn signal.



2. Release the signal stalk.

3. The turn signal will cancel when the turn is complete.

An audible beep is associated with each time a turn indicator is activated.

! WARNING

After you complete a turn, shut the system off by returning the lever to the "OFF" (center) position. Failure to shut off a turn signal could confuse other drivers and result in an accident. An indicator lamp in the instrument panel will flash until the turn signal is turned off.

How to Turn on High Beams

The high beam function is operated by the same steering column lever for the turn signals. High beams will not turn on if the headlights are turned off.

1. Gently pull the **Turn Signal** lever toward the steering wheel until you hear the switch click and the beam changes.

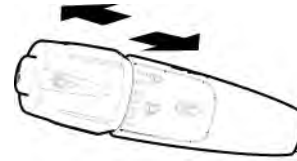

2. To return to previous beam, pull the **Turn Signal** lever towards the steering wheel again.

The blue indicator light in the instrument panel will turn ON when the high beams turn on.

How to Momentarily Flash High Beams

The "flash to pass" high beam function is operated by the same steering column lever for the turn signals. The high beam flash to pass will work if the headlights are not on.

1. Gently push the turn signal lever, away from the steering wheel.

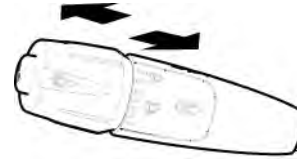

- The lever will automatically return when the lever is released.

The blue indicator light in the instrument panel will momentarily turn ON and the high beams will flash. The high beams will not remain on if the lever is still pressed.

	NOTE
Continued pressing of the high beam flash will not keep the high beams on.	

Operate the Windshield Wipers

This vehicle is equipped with a two speed, intermittent windshield wiper system. The windshield wiper system is integrated with the exterior lights so that the low beam headlights will turn on when the windshield wipers turn on.

	WARNING
Clean blades regularly with a damp cloth to remove road film and wax buildup. DO NOT drive with worn or dirty wiper blades. They can reduce visibility, making driving hazardous	

which may lead to an accident resulting in death or personal injury.

	CAUTION
DO NOT use antifreeze or engine coolant in the windshield washer reservoir, damage to seals and other components will result.	

To override this function, turn the headlights on and then off again. Permanently overriding this functionality is attainable via the Settings Menu in the instrument cluster display. Go to **Settings > Wiper Interlock** and turn this value to OFF. Avoid running the wiper blades over a dry windshield to prevent scratching the glass. Spray on washer fluid first. A scratched windshield will reduce visibility. A seven-position rotary wiper switch (located on the turn signal lever) operates the windshield wipers and washer. If you need to use the windshield wipers:

- Rotate the end of the turn signal lever to change the wiper mode from off to on.

- Rotate the outer knob of the turn stalk lever to adjust the wiper speed.

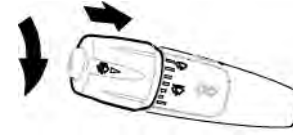

- Four levels of intermittent speeds
- Low wiper speed
- High wiper speed

How to Flash Marker and Clearance Lights

A button on the end of the Signal Turn stalk will momentarily flash the marker and clearance lights when pushed.



How to Spray Windshield Washer Fluid

This vehicle is equipped with a function to wash the windshield and simultaneously engage the wipers.



CAUTION

If the electric pump is operated for a long period (more than 15 seconds) with a dry reservoir, the pump motor may be damaged.

If you need to use the windshield washer:

1. Push the **Turn Signal Lever Outer Knob** in.

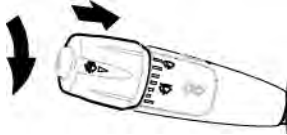

- Press and hold will activate the washer fluid and wipers.
- Instant press and release will activate the washer fluid only.

Steering Wheel Controls



CAUTION

Under no circumstances should you attempt to service the steering wheel, clockspring, or any of the electrical wiring in the multiplex system, or any steering components (steering column, steering driveline or steering gear). Tampering with these components may result in an inoperable multiplex system.

The steering wheel contains controls for commonly used functions so that the operator does not have to take their hands off of the steering wheel to operate. These controls are also used to interface with the display.

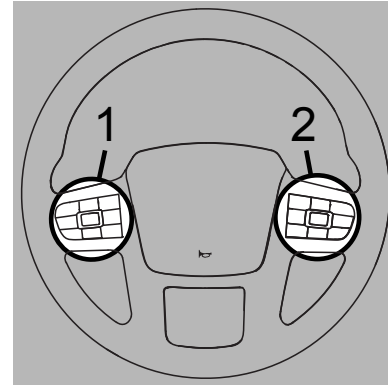

1. Left switch pod
2. Right switch pod

Switches on the left side of the horn pad, including the toggle switch, manage vehicle speed functions, cruise control, and optional features such as the variable road speed limiter (VRSL), adaptive cruise control (ACC), and predictive cruise control (PCC). See [Cruise Control](#) on page 123. Switches on the right side control infotainment and navigate and configure the instrument cluster (see [Cab Accessories](#) on page 110 and [Peterbilt Digital Display Controls](#) on page 54).

Ignition Key Switch

The ignition key switch located to the left of the steering column has four positions: ACC (Accessories), OFF, ON, and START.



OFF: In this position all accessories are OFF (except those listed below) and you can remove the key.

The following lights and accessories have power when the key is in the OFF position:

- brake lights
- emergency hazard flasher
- dome and courtesy lamps (on doors)
- electric horn
- cigarette lighter
- tail lights

- marker lamps
- headlights
- radio station memory
- instrument lights
- auxiliary power
- instrument panel memory settings

ACC (Accessory): With the key in this position you can play the radio, defrost mirrors (if equipped with mirror heat) or use other accessories.

ON: In the ON position all circuits are energized. Panel warning lights will light and the buzzer will sound until (1) the engine is started, (2) normal oil operating pressure is reached, and (3) air brake system pressure is above 65 psi (441 kPa). In this position, the ignition key cannot be removed.

START: Turn the key to this position to start your engine. Release the key after the engine has started.

Exterior Lighting Self-Test

When the feature is engaged, via a switch on the dash, it will illuminate the:

- Park lights

- Side marker lights
- Hazard/turn signals
- Low beam headlamps
- First set of fog/driving lights

The test will turn those lights off and then illuminate the:

- Park lights
- Side marker lights
- High beam headlamps
- Stop/Brake lights

After turning these lights off, the system will resume testing the first set of lights. The light test will eventually stop on its own. The operator may interrupt the test by turning the vehicle off or pressing the switch a second time while the test is running. The operator can verify light functionality by visibly watching the lights from outside the vehicle or by observing the instrument cluster for lighting-related warnings. The ELST will also start the Systems Check ([Systems Check](#) on page 30).

Test the Exterior Lights

To start the Exterior Light Self Test (ELST) feature:

1. Park the vehicle and set the parking brakes.
2. Insert the key into the ignition and turn the key to the ON position. Allow the vehicle to run through bulb check.
3. Press the momentary switch on the dash to start the ELST.



Heating and Air Conditioning

This vehicle's heating and air conditioning system controls are located in the header. If this vehicle is a Dual Sit and Steer configuration, there will be a control installed above both driver's positions. Vehicles with dual steer configuration will have two air conditioner controls that can modify the air temperature settings for the cab.

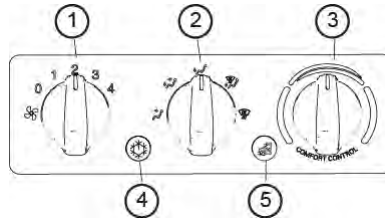

1. Fan Control
2. Air Distribution
3. Air Temperature Control
4. Air Conditioner Button for Cold Air
5. Recirculation Button

WARNING

DO NOT drive with visibility reduced by fog, condensation, or frost on the windshield. Your view may be obscured, which may result in property damage, personal injury, or death. For clear visibility and safe driving it is extremely important for you to follow the instructions pertaining to the function and use of the ventilation/heating and defogging/defrosting system. If in doubt, consult your dealer. Maximum heating output and fast defrosting can

be obtained only after the engine has reached operating temperature.

WARNING

Exhaust fumes from the engine contain carbon monoxide, a colorless and odorless gas. DO NOT breathe the engine exhaust gas. A poorly maintained, damaged, or corroded exhaust system can allow carbon monoxide to enter the cab. Entry of carbon monoxide into the cab is also possible from other vehicles nearby. Failure to properly maintain your vehicle could cause carbon monoxide to enter the cab, resulting in personal injury or death.

**WARNING**

Never idle your vehicle for prolonged periods of time if you sense that exhaust fumes are entering the cab. Investigate the cause of the fumes and correct it as soon as possible. If the vehicle must be driven under these conditions, drive only with the windows open. Failure to repair the source of the exhaust fumes may result in death, personal injury, equipment or property damage.

**CAUTION**

Do not stay in the vehicle with the engine running or idling for more than 10 minutes with the vehicle's Heater and A/C ventilation system in RECIRC or

at LOW FAN SPEED. Even with the ventilation system on, running the engine while parked or stopped for prolonged periods of time is not recommended.

**NOTE**

Keep the engine exhaust system and the vehicle's cab ventilation system properly maintained. It is recommended that the vehicle's exhaust system and cab be inspected (1) By a competent technician every 15,000 miles (24,140 km); (2) Whenever a change is noticed in the sound of the exhaust system; or (3) Whenever the exhaust system, underbody, or cab is damaged.

**NOTE**

If you are required to idle your vehicle for long periods of time, install an auxiliary heater or automatic idle control. These auxiliary devices can reduce fuel consumption and save you money.

**NOTE**

If you are parked next to idling vehicles, move your vehicle or do not stay in your vehicle for prolonged periods of time.

Air Conditioner Control Panel

Symbols for the air conditioning control panel











Image	Function
	<p>This switch controls the source of the air flowing into the heater and air conditioner unit.</p> <p>Recirculated air may reduce the amount of time needed to cool down the interior of the vehicle (when used with A/C) and may also help reduce undesired outside odors from reaching the interior of the vehicle. This button can be engaged manually in any non-defrost modes.</p> <div data-bbox="337 469 1419 580" style="border: 1px solid black; padding: 5px;"> <p> NOTE</p> <p>You may notice changes in sound between recirculated mode and other airflow modes.</p> </div>
 	<p>Turning this dial clockwise from the OFF position turns the fan ON and increases the fan speed.</p> <p>This button turns the A/C compressor on and off. When using the Max Def function the user will not be able to turn off the AC compressor with this button.</p> <div data-bbox="337 751 1419 884" style="border: 1px solid black; padding: 5px;"> <p> NOTE</p> <p>Fan Control Dial must also be in the ON position for A/C to be on. A/C engages automatically in AUTO, defrost, and floor/defrost.</p> </div>

Image	Function
	Floor and De-mister Vents
	*Defrost and De-mister Vents
	Instrument Panel, De-mister and Floor Vents
	Instrument Panel and De-mister Vents
	Floor, De-mister Vents and *Defrost Vents

Tips for Efficient Cooling

An air conditioner can reduce fog build up on the windshield by setting it to the defrost or the floor/defrost air selection. To increase the effectiveness of the air conditioner, use the A/C button in the ON position, increase the air temperature setting and/or increase the fan speed. If the cabin becomes humid or damp, use the air conditioner with the fan on, with fresh air (not in recirculate air mode) and

the A/C in the ON position to dry the cabin air. In situations where more cooling of the cab is required, make sure the system is in the recirculation mode. This setting will be more effective than using fresh air.

How to Manually Control the Air Conditioner for the Cab

The engine must be running for the heater and air conditioner to generate hot and cold air.

* Fresh air and air conditioning are automatically turned ON.

To Cool

1. Push the Fresh Air/Recirculation Switch to the Fresh Air mode (Blue indicator light off). Manually setting the system to recirculate air will increase the effectiveness and uses the least amount of fuel.



2. Turn ON the Fan Control Dial to the desired fan speed.



3. Turn Temperature Dial to Desired Setting.
4. Turn the Air Flow Control Dial to Dash Vents.



5. If the outside air is not cold enough to cool the cab, press to engage the compressor which will deliver colder air.



6. For more cooling effect, you may need to press the switch back to

recirculation mode.



To Heat

1. Turn the Fan Control Dial ON to the desired fan speed.



2. Turn the Air Flow Control Dial to Floor Vents.



3. Adjust the Temperature Control Dial clockwise until the air temperature feels comfortable.
4. Using this function in "manual" mode will provide the maximum heating performance.

To Dehumidify

1. Push the Fresh Air/Recirculate Switch to the Fresh Air mode (Blue indicator light off).



2. Turn ON the Air Conditioning Switch (Blue indicator light on).



3. Turn ON the Fan Control Dial to the desired fan speed.



4. Adjust the Temperature Control Dial until the air temperature feels comfortable.
5. The air conditioner removes moisture from the air while the heater heats the air.

To Defog and Defrost the Windshield

1. Turn the Fan Control Dial clockwise to the highest fan speed.



2. Turn the Air Flow Control Dial to Defrost Vents.



3. Fresh air and air conditioning are automatically turned ON.
4. Adjust the Temperature Control Dial clockwise to full heat.

CAUTION

During extreme cold weather, DO NOT blow hot defroster air onto cold windshields. This could crack the glass. Turn the Air Flow Control Dial to Defrost and adjust the fan speed accordingly while the engine warms. If the engine is already warm, move the Temperature Control Dial to "cool," then gradually increase the temperature when you see that the windshield is starting to warm up. Failure to comply may result in equipment damage.

Sleeper Heater and Air Conditioner Controls (Option)

Unlike the cabin air temperature controls, the sleeper temperature control will alter the air temperature based on the knob setting.

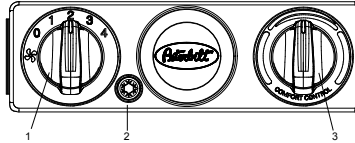

1. Air speed
2. Compressor
3. Temperature adjustment

The temperature control is not keyed to specific temperatures. Turning counterclockwise means cooler than it is now. Clockwise means warmer than it is now. Once the desired temperature is reached, the system will maintain it automatically. A separate switch on the dash HVAC unit will send power to the "bunk" or sleeper control unit the button on the cab HVAC unit must be pressed and in the ON mode to use the sleeper controls.

i NOTE

The sensor is located on the sleeper HVAC control panel and measures the sleeper air temperature at the panel. There will be a time delay between temperature control adjustment and

sleeper air temperature change. Also, be careful of any heat source which could affect the air temperature by the sensor. Avoid hanging items (shirt, jacket, hat, etc.) which could block the airflow to the sensor.

Sleeper Alarm Clock

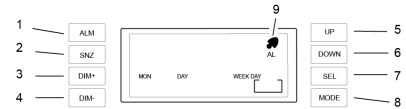

1. Alarm - press to turn on the alarm
2. Snooze - press to snooze the alarm bell
3. Dimmer/brighter - press to make display brighter
4. Dimmer/darker - press to make display less bright
5. Increase value of setting
6. Decrease value of setting
7. Select - press to choose the setting being changed while adjusting the either the time or the alarm

8. Time and Alarm value setting - press to change time/date and or alarm setting
9. Active alarm icon - alarm is activated when this icon appears

Turning the Alarm On/Off

Press the **ALM** button to turn the alarm on and off. The icon (9) will illuminate when the alarm is active. When time reaches the set time the alarm will ring. If the **SNZ** button is not pressed, the alarm will continue ringing for 15 minutes then will automatically stop. Pressing any other button except **SNZ** (2) will turn the alarm off.

Snooze Operation

When the alarm is ringing press the **SNZ** button (2) to silence the alarm for 9 minutes. The small bell icon (9) will flash until the alarm is shut off. The **SNZ** button can be used as many times as desired.

Dim Control Operation

Press the DIM+ or DIM-buttons (3, 4) to change the brightness of the display.

Set the Sleeper Alarm Clock Time

1. Press the **MODE** button until the screen begins flashing.
2. Use the **UP** and **DOWN** buttons to adjust the value.
3. Press the **SEL** button to adjust the next setting and use the **UP** and **DOWN** buttons to change the value.
4. Repeat this for all settings. The alarm clock will scroll in the following order each time you press the **SEL** button.
 - Year
 - Month
 - Day
 - Hours
 - Minutes
5. Press the **MODE** button once you have set the minutes which will exit and save your settings.

Set the Sleeper Clock Alarm

1. Press the **MODE** button twice until the screen displays the AL icon.
2. Use the **UP** and **DOWN** buttons to adjust the setting.
3. Press the **SEL** button to adjust the next setting and use the **UP** and

DOWN buttons to change the setting.

4. Repeat this for all areas. The alarm clock will scroll in the following order each time you press the **SEL** button.
 - Hours
 - Minutes
5. To exit and save your settings, press the **MODE** button once you have set the minutes.

Cab Accessories

Radio (Option)

Your vehicle has one of two stereo systems. An AM/FM stereo receiver is standard equipment and may have a combination of CD, satellite radio, USB media, or Bluetooth. A stereo system integrated with GPS navigation and telematics is also available (option). For instructions on how to operate your particular radio, see the supplemental operating manual for those units. The stereo mutes in the event of a warning on the display or telltales.

Cigarette Lighter and Ashtray (Option)



NOTE

The 12V accessory power port will operate with the ignition key in either the OFF, ACC (accessory), or ON position.

This vehicle comes standard with two cupholders and power ports located in the center of the dashboard. This vehicle may have the optional ashtray insert (for the cupholder) and the optional cigarette lighter instead of a power port. To operate, push in on the knob end of the lighter. After a few moments, the lighter will automatically pop out, glowing hot and ready to use. After use, insert the lighter back into the socket without pushing all the way in. The socket of the cigarette lighter may be used to operate 12V, 15 amp appliances, such as a hand spotlight or small vacuum cleaner.



CAUTION

Do not attempt to operate a cigarette lighter using the 12V power port recep-

tle. A cigarette lighter inserted into the 12V power port will heat up and be expelled into the cab, potentially causing personal injury, fire, and property damage.



WARNING

DO NOT place paper or other combustible substances in an ashtray, it could cause a fire. Keep all burnable materials, besides smoking materials, out of the ashtray. Failure to comply may result in death, personal injury, equipment or property damage.



WARNING

DO NOT exceed the voltage/ampere capacity of the accessory power port. It could result in a fire. Follow all warnings and instructions in the operator's manual for the appliance you are using. Failure to comply may result in death, personal injury, equipment or property damage.

Glove Box

A glove box is provided to store important documents, the vehicle literature set (including this Operator's Manual) and other related materials. You can choose from a variety of other interior storage options to store your personal supplies or small tools:

- center console
- map pocket on the door
- overhead storage compartments



WARNING

DO NOT drive with the glove box open, it can be dangerous. In an accident or sudden stop, you or a passenger could be thrown against the cover and be injured. To reduce the risk of personal injury during an accident or sudden stop, keep the glove box closed when the vehicle is in motion.



WARNING

DO NOT carry loose objects in your cab, it can be dangerous. In a sudden stop, or even going over a bump in the road, they could fly through the air and strike you or a passenger. You could be injured or even killed. Secure all loose objects in the cab before moving the vehicle. Carry any heavy objects such as luggage in the exterior storage compartment and close it securely.

Appliances

If your vehicle is equipped with a television, or other appliance, be sure they are compatible with your vehicle's electrical system. Secure them in the cab so they cannot come loose in a sudden stop.



WARNING

In a sudden stop or collision a heavy object in your cab could strike you or anyone with you. You could be injured or even killed. Secure any appliance

(such as a radio, or TV) you add to your sleeper or cab.

Vehicle Telematic System

Your vehicle may be equipped with an onboard telematics system. This system is a Global Positioning Satellite (GPS)-linked computer. It receives input from multiple sources to locate your vehicle. Read and understand the Supplemental Telematics and Navigation System Owner's Manual and observe the Warnings, Cautions, and Notes that follow before using the system.



WARNING

Verify legal weight and height restrictions for the route suggested by the telematic system. Failure to verify height restrictions could lead to causing death, personal injury or property damage. Failure to verify weight restrictions could result in a traffic infraction.



WARNING

Only glance at the system monitor while driving. Prolonged periods of viewing while driving could result in an accident involving death or personal injury.



WARNING

DO NOT program the telematic system while driving. Always stop your vehicle when programming or changing the settings on the telematic system. Programming the system while driving can cause you to take your eyes off the road, which could result in an accident involving death, personal injury or equipment damage.

**WARNING**

Regardless of how and where the navigation system directs you, it is your responsibility to operate the vehicle in a safe and legal manner. Failure to comply may result in death, personal injury, equipment or property damage.

**WARNING**

Ensure the volume level of all audio devices is set to a level that still allows you to hear outside traffic and emergency vehicles. Failure to comply may result in death, personal injury, equipment or property damage.

**CAUTION**

DO NOT rely on the telematic system to route you to the closest emergency services. Not all emergency services are in the database.

**NOTE**

The map database is the most current available at the time of production. The database is designed to provide you with route suggestions and does not take into account the relative safety of a suggested route or of factors that may affect the time required to reach your destination. See the Supplemental Navigation System Owner's Manual for more information.

Care of the Display Screen

From time to time it may be necessary to clean the display screen. To clean the screen, dampen a clean, soft, lint-free cloth with water only. A mild glass cleaner that does not contain alcohol or ammonia may also be used. Cleaners that contain alcohol and/or ammonia will eventually dry-out, crack and "yellow" the screen. Wipe the screen gently back and forth. You can also use a commercial cleaner especially designed for LCD screens.

Using the Telematic System

Screen Display On/Off

1. Press and hold the **POWER/LIGHT** button for approximately 1 second.
2. After the display has been turned on, the following Warning/Informational screen will appear.

Warning/Informational Screen**WARNING**

DO NOT let this device distract you while driving. Always concentrate on your driving. Distractions could cause an accident resulting in injuries to you or others.

IMPORTANT

WARNING



DO NOT let this device distract you while driving. Always concentrate on your driving. Distractions could cause an accident resulting in injuries to you or others.

Disclaimer: Map data may be inaccurate and navigation routes may not be available for larger size vehicles. Regardless of how and where the navigation system directs you, it is your responsibility to operate the vehicle in a safe and legal manner. **Note:** Before using this system, read the Owner's Manual and learn how it operates. Some functions of this system will not operate when the truck is moving.

3. After reading the information, touch the **T** in the upper right corner of the screen with your finger indicating you acknowledge and

4. understand the information. The **MENU** screen will automatically appear next.
To turn the system off, press and hold the **POWER/LIGHT** button for 3 seconds.
Disclaimer: The vehicle manufacturer is not responsible for erroneous map data, misrouting or any downtime or other damages associated with or arising out of the use of the Navigation System.

Chapter 4 | DRIVING

4

Starting and Operating.....	117
Starting and Warming Up.....	117
Engine Operations.....	121
Transmission.....	132
Brakes.....	135
Axle and Suspension.....	146
Engine Aftertreatment System.....	154
Trailer Operations.....	154
Driving Tips and Techniques.....	158
Sleeper Bunks.....	161
Stopping the Vehicle.....	162

Starting and Operating

Since each vehicle is custom-equipped, all engine operation instructions in this manual are general. You will want to consult the manual for your engine to find out details about your specific engine's needs. You may need to use a slightly different procedure from the one outlined here.

Systems Check Summary

System Check Display with TPMS

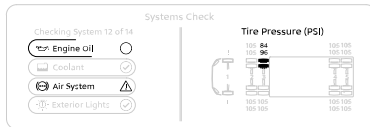

Once the Systems Check has completed, the results will display in a summary. A detailed explanation of this summary can be viewed by accessing the Menu after a Systems Check has completed.

Anti-Theft

Anti-Theft prevents starting the engine and accessing the settings sub-menu. If Anti-Theft does not show in the settings sub-menu, see your authorized dealer to install Anti-Theft.

If Anti-Theft is enabled, turning the ignition switch to START prompts the operator to enter the passcode. Once the correct passcode is entered, you have five minutes to start the engine or the passcode must be re-entered.⁴

To enable or disable Anti-Theft, change Anti-Theft (ON/OFF) in the settings sub-menu and enter the current passcode.

Starting and Warming Up

How to Start Vehicle in Normal Weather



CAUTION

Never operate the starter motor while the engine is running. The starter and

flywheel gears could clash or jam, severely damaging them.



NOTE

Some starters are equipped with over-crank protection. Check the Engine Operation and Maintenance Manual for details.

When the outside temperature is above 50°F (10°C), you can use the following procedure. If Anti-Theft is enabled, the first time you turn the ignition switch to START, you will need to enter the Passcode.

1. Set the parking brake.
2. Put your main transmission in Neutral.
3. Disengage (depress) the clutch (with manual transmission).
4. Turn the key switch to START:
 - If Anti-Theft is enabled, you will need to enter the Passcode (see How to Enter the Passcode). Turn the key switch

⁴ The five minute timer can be postponed in one minute intervals using any steering wheel switch.

- to START, again, to start the engine, or
 - If the engine started as a result of Step 4, proceed to Step 5.
5. If the engine does not start within 30 seconds, release the ignition switch. To avoid overtaxing the starter motor or the batteries, don't use the starter for more than 30 seconds. Let the starter motor cool and the batteries recover for two minutes before trying again. If the engine still won't start after a couple of tries, check the fuel lines for possible fuel starvation or air leaks. Starting failure may mean fuel is not reaching the injectors.
 6. As soon as the engine starts, begin to watch the oil pressure gauge. Check your engine manufacturer's manual for the right pressure for your engine. If the oil pressure doesn't rise within a few seconds, stop the engine. Find out what is wrong before restarting the engine.
 7. Slowly engage (release) the clutch after the engine has started.
 8. Wait for the oil pressure gauge to reach normal operating pressure

before operating the vehicle or idling faster than 1,000 rpm.

Tips to Remember When Starting Vehicle in Cold Weather

If you follow a few simple guidelines, you will extend the service life of your engine:

- Keep the electrical system in top condition.
- Use the best quality fuel of the recommended grade.
- Use recommended engine lubricating oil.
- For manual transmissions and auxiliary transmissions, leave the transmission in neutral and allow the transmission lubricating oil to warm up (approximately 3-5 minutes) before operating vehicle.

Engine Block Heater (Option)

To preheat the engine before starting, plug the optional engine block heater into a properly grounded AC electrical source. DO NOT start the engine with the heater plugged in.



WARNING

Engine block heaters can cause fires which may result in property damage, personal injury, or death if not properly maintained and operated. Regularly inspect the engine block heater wiring and connector for damaged or frayed wires. DO NOT use the heater if there are any signs of problems. Contact your authorized dealer or the manufacturer of the heater if you are in need of repairs or information.



CAUTION

Always unplug heater before starting the engine. Damage to the cooling system could occur if the heater is not turned OFF (unplugged).

Depending on engine make, when the temperature falls below -10°F (-24°C), the block heater is required.

Engine Warm Up

Engine warm-up allows oil film to be established between pistons and liners,

shafts and bearings while your engine gradually reaches operating temperature.

1. After you've started your engine, idle it at approximately 600 rpm while you check:
 - a. oil pressure
 - b. air pressure
 - c. alternator output
2. After a few minutes of idling at 600 rpm, increase your idle speed to 900 or 1,000 rpm. Continue your warm-up. This procedure allows oil to warm and flow freely while pistons, liners, shafts, and bearings expand slowly and evenly. In extremely cold temperatures, you may have to increase idle speed.

**NOTE**

In colder climates where the temperature is often below freezing, the warm-up for turbocharged engines is especially important. Chilled external oil lines leading to the turbocharger will slow the oil flow until the oil warms, reducing oil available for the bearings. Watch the engine oil temperature or pressure gauge for a warming trend

before increasing engine idle speed (rpm).

3. Continue the engine warm-up until the coolant temperature reaches at least 130°F (54°C). At this temperature, you can use partial throttle. Wait until the coolant temperature is at least 160°F (71°C) before operating at full throttle.
 - a. Under most circumstances, idling your engine for long periods merely wastes fuel. In severe arctic weather conditions, however, you may need longer idling to be sure all parts of your engine are fully lubricated.

**WARNING**

Exhaust fumes from the engine contain carbon monoxide, a colorless and odorless gas. DO NOT breathe the engine exhaust gas. A poorly maintained, damaged, or corroded exhaust system can allow carbon monoxide to enter the cab. Entry of carbon monoxide into the cab is also possible from other ve-

hicles nearby. Failure to properly maintain your vehicle could cause carbon monoxide to enter the cab, resulting in personal injury or death.

**WARNING**

Never idle your vehicle for prolonged periods of time if you sense that exhaust fumes are entering the cab. Investigate the cause of the fumes and correct it as soon as possible. If the vehicle must be driven under these conditions, drive only with the windows open. Failure to repair the source of the exhaust fumes may result in death, personal injury, equipment or property damage.



WARNING

To reduce the chance of personal injury, vehicle damage, and/or death from overheated engines, which can result in a fire, never leave the engine idling without an alert driver present. If the engine does overheat, as indicated by the engine coolant temperature lamp, immediate action is required to correct the condition. Continued unattended operation of the engine, even for a short time, may result in serious engine damage or a fire. Failure to comply may result in death, personal injury, equipment or property damage.



CAUTION

The use of a winterfront can result in excessive coolant, engine oil, and intake air temperatures, which may lead to overheating and possible engine damage.



CAUTION

DO NOT allow your engine to idle, at low rpm (400-600 rpm), longer than five minutes. Long periods of idling after the engine has reached operating temperatures can decrease engine temperature and cause gummed piston rings, clogged injectors, and possible engine damage from lack of lubrication. The normal torsional vibrations generated can also cause transmission wear.



NOTE

Keep the engine exhaust system and the vehicle's cab ventilation system properly maintained. It is recommended that the vehicle's exhaust system and cab be inspected (1) By a competent technician every 15,000 miles (24,140 km); (2) Whenever a change is noticed in the sound of the exhaust system; or (3) Whenever the exhaust system, underbody, or cab is damaged.



NOTE

If you are parked next to idling vehicles, move your vehicle or do not stay in your vehicle for prolonged periods of time.

How to Warm Up the Transmission

In cold weather (below 32°F (0°C), you may find shifting sluggish when you first start up. Transmission warm-up is especially important at this time, but it is always a good idea to warm-up your transmission before starting out on the road.

To warm-up the transmission lubricating oil during engine warm-up, with a single transmission (manual and automatic):

1. Put the transmission in Neutral.
2. Release the clutch pedal (manual only) and operate the transmission in neutral for 3 to 5 minutes prior to operating the transmission in either forward or reverse range.
3. If you have a two-transmission combination:
 - a. Put the main transmission in gear.

- b. Put the auxiliary transmission in Neutral. This will allow the transmission countershaft to turn, agitating the oil and warming it.

Engine Operations

Indicators around the speedometer

Icons around the Speedometer

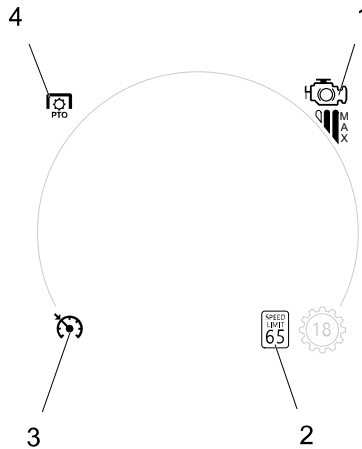

1. Engine Brake
2. Speed Limit
3. Cruise Control, Adaptive Cruise (Option), Predictive Cruise (Option)
4. Power Take Off

Engine Brake Operation

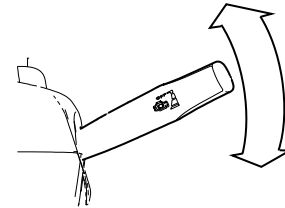

Moving the lever clockwise will engage the engine brake. Increase the amount of engine brake by moving the lever further clockwise. Each position has a corresponding level of engine brake.

Position	Amount of Engine Brake
Off	0%
1	33%
2	66%
3	100%

Engine Brake Indicator

Engine Brake Icon (1 bar)



Engine Brake Icon (3 bar+MAX)



The vertical bars represent the amount of engine brake, up to and including MAX mode. When Engine Braking is active, the indicator will change from white to green.

How to change Fast Idle Control (FIC) Speed

The truck must be stationary, the transmission in Neutral, and the Park Brake set.



CAUTION

Do not let the engine RPM operate beyond the maximum governed RPM. Operating the engine above the maxi-

imum governed RPM may result in Engine damage.

1. Press the Cruise Control **ON/OFF**. The white FIC indicator will appear near the Speedometer/ Tachometer, indicating the FIC is enabled.
2. To set the FIC speed
 - Press **RES -** to resume last used FIC speed, or
 - Use the Accelerator to increase RPM, then press **SET +**, or
 - Press and hold **SET +** to increase and set the new FIC speed, or
 - Press and hold **RES -** to reduce FIC speed, then press **SET +**.

The FIC indicator will turn green, signifying that the FIC is activated.

How to Start the PTO

PTO **Mode** can be activated in a number of different ways. If your vehicle is equipped with the **MX engine**, PTO Mode is typically activated by **engaging a PTO**, or by using the Dash PTO Mode Control Switch. For

the **Cummins engine**, PTO Mode is typically activated by engaging a PTO, or by setting the Cruise Control Switch to ON but while the *vehicle is stationary*. The following information below provides the basic process of enabling and activating PTO engine speed control, and what the operator should observe during this process.



NOTE

Actual PTO engagement/disengagement may be delayed momentarily since it is controlled by the air system and mechanical movement.



CAUTION

Increasing engine rpm before the PTO is actually engaged could prevent the PTO from engaging and/or cause PTO damage.

1. Toggle the **PTO ON/OFF** switch, or the Dash PTO Mode Control Switch, to the ON position. Text indicating PTO engagement and/or PTO Mode control location will

appear inside the speedometer. (Vehicles equipped with a PACCAR or Eaton automated transmission will display the letters AN in the transmission gear indicator when the PTO is engaged).

2. Press the Cruise Control (CC) **ON/OFF** switch to enable PTO speed control operations. A white speed control enabled icon will appear.
3. Optional: If your PTO has designated PTO presets located on the dash:
 - If you have dash mounted PTO preset switches, toggle the desired **PTO Preset** switch, or
 - Using the dash mounted **PRESET Increment and Decrement** switch, cycle through the PTO presets to select the desired preset.

PTO Speed Control is now active. Vehicles with an MX engine will display a green PTO indicator with a target PTO engine speed.
4. Optional: If you don't have dash mounted PTO preset switches, press the **SET +** and **RES -** buttons located on the steering

wheel to command a desired engine speed.

PTO Speed Control is now active. Vehicles with an MX engine will display a green PTO indicator with a target PTO engine speed.

5. To increase or decrease PTO engine speed use a combination of short and long presses of the **SET +** and **RES -** buttons located on the steering wheel (the cruise control buttons when the vehicle is moving).

Vehicles powered with PACCAR MX Engines will display the PTO engine speed above the PTO indicator.

PTO Active Gauge

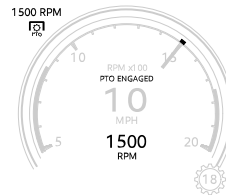

Cruise Control



WARNING

DO NOT operate the cruise control when operating on road surfaces with poor traction (wet, icy, or snow covered roads) or in heavy traffic. Accelerations caused by the normal operation of the cruise control could cause you to lose control of the vehicle resulting in an injury accident.

Cruise control functions and features may vary depending upon which engine you have. For a specific explanation of your cruise control, see the cruise control or engine manual included with your vehicle. This vehicle's electronic system will perform a 'rationality check' every time the vehicle is started. This check is to ensure that the service brakes are working before allowing cruise control to function. This safety feature is designed to ensure that a driver is able to cancel the cruise set speed by using the service brake pedal. The system will not allow cruise control operation if it does not pass the 'rationality check.' The display will prompt you to press the service brake pedal if it has not

been pressed since the vehicle has been started. In vehicles with Eaton transmissions, the cruise control switches may be located on the shift control knob. The left switch pod on the steering wheel contain buttons for the cruise control.

Left Switch Pod

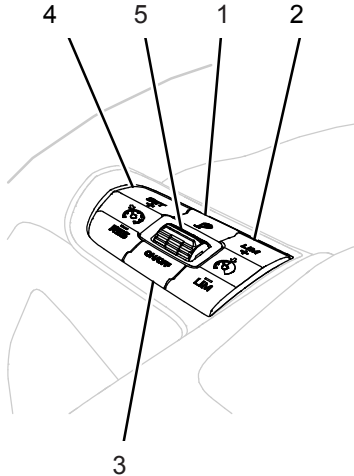

1. **Trip**
2. Variable Road Speed Limiter (VRSL) **LIM+** and **LIM-**
3. Cruise Control **ON/OFF**
4. Cruise Control (CC) **SET+** and **RES-**
5. **Toggle**

The switches on the left side of horn pad manage vehicle speed functions like cruise control and variable road speed limiter (option). If the vehicle has adaptive cruise control (option), predictive cruise control (option), etc., the toggle switch is also used to operate that system.

Cruise Control Indicator



This indicator shows the operator which Cruise Control function is currently enabled or active. This includes:

- Cruise Control
- Adaptive Cruise Control (optional)
- Predictive Cruise Control (optional)

i	NOTE
PCC not offered on 1.9m models.	

The indicator will appear white when the system is on and it will appear green when the cruise control set speed is active. For more information see [Cruise Control](#) on page 123.

How to Use Set Cruise Control Speed When Driving

These instructions DO NOT apply to Adaptive Cruise Control. While the buttons are also used to control PTO operations, these instructions are specifically for vehicle speed. The vehicle speed must be greater than 19 mph (30 kph) for PACCAR powered vehicles or 30 mph (49 kph) for Cummins powered vehicles and the engine speed must be over 1,100 rpm for the cruise set speed to work.

To Set the Cruise Speed

1. Turn the cruise function on by using the ON/OFF button
The cruise icon will appear in the display.



2. Accelerate the vehicle via accelerator pedal to the desired cruise speed.
3. Press the "SET +" button to set the cruise speed.

**NOTE**

Cruise Control may not hold the set speed going down hills. If the speed increases going down a hill, use the brakes to slow down. This will cancel Cruise Control.

The cruise set speed will appear in the display.

How to Change Cruise Set Speed

The vehicle cruise control must be ON and the cruise speed engaged.

1. To increase vehicle speed
 - Press or long press **SET +** until you reach the desired speed, or

- Use the Accelerator Pedal to reach the desired speed, and then press the **Set +**
2. To decrease vehicle speed, press or long press **RES –** until you achieve the desired speed, and then press **SET +**.

The new cruise speed can be seen next to the Cruise Control Indicator.

Canceling and Resuming Cruise Control

There are four ways to cancel the set speed in cruise control:

1. Tap the brake pedal
2. Tap the clutch pedal
3. Turn the cruise control system OFF (ON/OFF button on steering wheel)
4. Press the Variable Road Speed Limit buttons

Using the brake or clutch pedal to cancel set speed allows the operator to use the RESUME feature. Pressing the "- RES" button will resume the vehicle speed previously set.

Pressing ON/OFF once will deactivate cruise control, and pressing it twice will turn off the system. When turning the system OFF, the previous set speed is removed from memory. The operator will

have to manually reset the vehicle's cruise speed.

Variable Road Speed Limiter (option)

The Variable Road Speed Limiter (VRSL) prevents the vehicle from exceeding a chosen vehicle speed limit. This limit is selected by the operator and can be changed while driving. VRSL uses various braking methods to enforce the limit including ignoring further input from the accelerator pedal, but will only use engine braking if available and enabled. VRSL replaces the Cruise Control indicator when active and will show the VRSL limit to the right of the indicator. This limit is shown in gray but turns white when actively limiting vehicle speed. MX engines, additionally, show "LIMITED" on the speedometer.

When active, the VRSL speed limit can be changed using the **LIM+** and **LIM-** buttons in the right, steering wheel switch pod. See How to Set the Variable Road Speed Limiter. Enabling VRSL will disable Cruise Control.

VRSL can be canceled by

- A long press of the Cruise Control **ON/OFF**.
- Stopping then parking the vehicle.

- Activating the PTO (option) (MX engine only).

How to Set the Variable Road Speed Limiter

The Variable Road Speed Limiter (VRSL) cannot establish a limit while the parking brake is set or the PTO is in operation. The minimum VRSL setting is 25 mph (40 kph). Enabling VRSL will disable Cruise Control if Cruise Control is active.

1. Press the Cruise Control **ON/OFF** button in the left, steering wheel switch pod.



Indicates that the VRSL feature is awaiting input.

2. Press, or press and hold, **LIM+** or **LIM-** to incrementally, or continuously, raise or lower the VRSL limit.

The green VRSL indicator will replace the Cruise Control indicator, indicating that VRSL is enabled. VRSL (like Cruise Control) will use the current vehicle speed as the VRSL limit until changed.

Pressing either **LIM+** or **LIM-** will adjust the VRSL limit while this feature is active.

Adaptive Cruise Control (Option)

Following Distance Five Bars



When Cruise Control is active, ACC will accelerate and slow the truck to maintain a chosen distance from a detected forward vehicle. Collision Mitigation will attempt to prevent a forward collision when advancing at speeds greater than 15 mph (24 kph). Please review the ACC section of this manual, and the manufacturer's manual, prior to driving this vehicle.

WARNING

Ultimate responsibility for the safe operation of the vehicle remains with the driver at all times. Even with Adaptive Cruise Control, the driver must remain alert, react appropriately and in a timely manner, and use good driving practices.

Failure to do so may result in death, personal injury and/or property damage.

Adaptive Cruise Display

The display area for Active Cruise will contain dynamic visuals related to whether a tracked vehicle is in front and the amount of following distance set for Active Cruise. It will show an outline of a car in the display area when the radar is tracking a vehicle. Once it locks on to a tracked vehicle, it will display horizontal bars to represent the amount of following distance from the tracked vehicle. Once it locks and tracks a target vehicle, the system will adjust the speed to accommodate the speed of the tracked vehicle in front of it.

No Tracked Vehicle

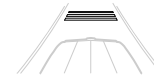

The operator can set the amount of following distance from the tracked vehicle. There are five preset distances to choose from, represented by horizontal bars between the hood and the forward car.

One bar represents the nearest following distance.

Following Distance One Bar

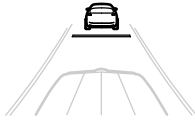

Five bars represents a farther distance.

Following Distance Five Bars



See [Set ACC Following Distance](#) on page 127.

Following Distance Alerts

The display will be white when the tracked vehicle in front is at a proper following distance. If the following distance decreases (less than 1.5 seconds), the following distance bars will turn amber. When the following distance decrease more (0.5 seconds), the following distance bars will turn red.

Collision Alerts

The display will show these messages with icons if the system predicts a collision either from approaching speed or because of a stationary object.

Adaptive Cruise - Brake!

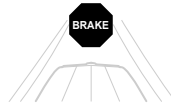

Some vehicles may present **OBJECT DETECTED** (option) in the display for the driver.

Adaptive Cruise - Object Detected

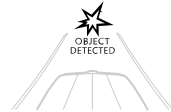

Set ACC Following Distance

Follow these steps to adjust the following distance for Adaptive Cruise Control:

1. Press the **Toggle** until the following distance bars illuminate in the view.

If the vehicle has Predictive Cruise Control, you may have to press multiple times to cycle through the other settings for PCC.

2. Rotate the **Toggle** up or down to choose the amount of following distance.
3. Push the **Toggle** again to set the following distance.

Lane Departure (Option)

Lane Departure is a feature that monitors the lanes markings on a road and will alert the driver if the vehicle departs from the lane it is traveling in. The following conditions must be present for the system to operate:

- The lanes are recognized (white with black outline) on both sides of the vehicle
- The vehicle is moving above 37 mph/60 kph
- The turn signals are not in use

The lanes will be black with a white outline if the system does not detect a lane marker. This may occur in certain situations such as construction zones, overlapping or changing lane markers.

Lane Departure Active and No Lanes Detected



Lane Departure Warning Alert (Option)

When equipped, an alert will occur when a lane marking is crossed without the use of the turn signal.

Lane Departure Active Warning Left



The operator can mute the audible Lane Departure Warning alert by using the dash mounted Lane Departure Disable switch. After 15 minutes or the next key cycle, Lane Departure Warning alert will be automatically unmuted. The mute switch will not mute any Adaptive Cruise Control alarms.

Lane Keeping Assist (Option)

Vehicles with Lane Keeping Assist will provide steering assistance to the steering wheel when it detects the vehicle is departing a lane without use of a turn signal. The system will turn the steering wheel in an attempt to nudge the vehicle in back into the lane. The steering assistance may always be overcome by the driver and the driver is expected to keep hands on the steering wheel at all times. Using this

feature may increase or decrease awareness to components that are in need of inspection or maintenance, such as (but not limited to) improper tire inflation, suspension, or brake drag.

The Lane Keeping Assist feature is enabled by default when the vehicle is on as indicated by a white icon. When the vehicle speed is above 40 MPH (65 km/h), the conditions are right, and the system is ready to assist in keeping the vehicle in the lane, the steering wheel portion of the icon below will turn green, indicating that the system is engaged and ready to assist in keeping the vehicle in the lane. The system may disengage if the system operating conditions are not met and re-engage once met. Some of these conditions include lane marking detection, vehicle speed, and system faults.

Lane Keeping Assist Enabled



WARNING

Ultimate responsibility for the safe operation of the vehicle remains with the driver at all times. Even with Lane Departure Warning or Electric Steer Assist, the driver must remain alert, react appropriately and in a timely manner, and use good driving practices. Failure to do so may result in death, personal injury and/or property damage.

Lane Keeping Assist Engaged



For the Lane Keeping Assist feature to safely operate, the driver must remain in control of the vehicle with their hands on the wheel. If the system cannot detect the presence of the driver's hands on the wheel, it will disengage the Lane Keeping Assist feature. After some time of not detecting the driver's input to the wheel, a warning will be given to keep hands on the wheel.

Predictive Cruise Control (Option)



Predictive Cruise Control (PCC) uses satellite technology and GPS maps to look at upcoming roads to dynamically calculate optimal fuel-efficient speed over a given terrain.

NOTE

There are many other factors that may influence the overall fuel economy of your vehicle (i.e., head wind and slope terrain, etc.).

Predictive Cruise Control operates similarly to standard cruise control. With PCC, vehicle speed is maintained without holding down the accelerator and can be used at 19 mph (30 km/h) or more. PCC will also actively recalculate and change the target cruising speed for best fuel economy rather than maintaining a constant set speed. The range of the PCC target cruise speed is defined by an overshoot and undershoot speed values.

These values are adjustable by the operator.

NOTE

Adaptive Cruise Control (ACC) has the ability to override Eco cruise. This is because ACC is designed to decelerate the vehicle to match the speed of traffic in front of the ACC equipped truck.

PCC Behavior

As the vehicle approaches the top of a hill, PCC will decrease the vehicle speed (up to 8% below the set speed) to prevent the vehicle from exceeding the set speed while traveling downhill. This will result in a smoother, more fuel efficient ride as the vehicle approaches the crest of the hill. Once over the crest, momentum takes over and the system allows a predetermined amount of speed over the set speed. PCC can also activate Neutral Coast (NC) mode. NC mode disengages the vehicle's driveline, reducing fuel consumption while maintaining overall vehicle speed. Once the vehicle can no longer maintain speed while coasting, NC is deactivated and the driveline re-engages.

If the driver has activated one of the vehicle's retarder systems (Engine, transmission, or driveline), the vehicle speed may increase until it reaches the cruise control set speed plus the retarder offset. For more information about engine retarders, see your vehicle Operator's Manual.

If the vehicle drops outside the speed range, PCC will accelerate the vehicle back to the minimum PCC speed.

As the vehicle reaches flat ground after the hill, PCC will maintain the set-speed until the crest of the next hill.

If the vehicle is equipped with Adaptive Cruise Control (ACC) and senses traffic slowing, it will override PCC and slow the vehicle. This event will cancel PCC only if the service brakes are required to slow the vehicle. If the service brakes are not used by ACC to maintain a safe following distance, PCC will remain engaged and resume automatically after the ACC event.

NOTE

PCC was calibrated using a loaded vehicle. Your results may vary, depending on your vehicle's configuration.

PCC Interrupt

There are three conditions that will automatically deactivate PCC:

- If there is no data for the current road.
- If the GPS signal is lost.
- If the PCC system detects a fault.

When this happens, the vehicle will revert to standard cruise control. This CC state will be standard cruise control which will maintain the same cruise speed that was selected for PCC.

Once the system regains GPS signal and road data, PCC will resume.



NOTE

PCC Map coverage will include most interstate and state highways. If you happen to leave a supported roadway, the PCC will deactivate. Standard cruise control will automatically step in to maintain the vehicle speed.

Troubleshooting

The display will show a message if it detects an error with the PCC system. PCC faults may result from the unavailability of map, slope, vehicle

position, etc. To effectively diagnose and clear the fault codes, the truck must be taken to your local dealership.

Fuel Economy Savings Not Achieved

Certain conditions may cause the optimal vehicle speed, calculated by PCC, to be overruled. For example, PCC will be overruled in the following scenarios:

- Greenhouse Gas functionality
- Adaptive Cruise Control Following Event (if equipped)
- Adaptive Cruise Control Error State (if equipped)

Disabling Predictive Cruise Control

To disable PCC and enable standard cruise control, the truck must be taken to an authorized dealer.

Software Information

The PCC ECU Software version and Map Data Version number can be found in the Menu [Truck Information](#) on page 69. . It may take up to two minutes for this information to be displayed after the truck has been keyed-on.

PCC Controls

PCC uses the same buttons as Cruise Control. See [Cruise Control](#) on page 123.

PCC Undershoot

Follow these steps to adjust the undershoot value for Predictive Cruise Control:

1. Press the **Toggle** twice.



The bottom value below the set speed will illuminate.

2. Rotate the **Toggle** up or down to set the value.
3. Push the **Toggle** again to confirm the value.

If you want to set the Overshoot value, see [Predictive Cruise Overshoot](#) on page 64.

Engine Fan Control

The engine fan switch on the dash has a manual and an automatic mode. In the manual mode, the engine fan will engage

until the switch is back into automatic mode. In automatic mode, the engine fan operation is controlled by the engine computer.

**WARNING**

DO NOT work on or near the fan with the engine running. Anyone near the engine fan when it turns on could be injured. If it is set at MANUAL, the fan will turn on any time the ignition key switch is turned to the ON position. In AUTO, it could engage suddenly without warning. Before turning on the ignition or switching from AUTO to MANUAL, be sure no workers are near the fan. Failure to comply may result in death or personal injury.

**CAUTION**

DO NOT operate the engine fan in the MANUAL position for extended periods of time. The fan hub was designed for intermittent operation. Sustained operation will shorten the fan hub's

service life as well as reduce fuel economy.

**CAUTION**

The fan or equipment near it could be damaged if the fan turns on suddenly when you do not expect it. Keep all tools and equipment away from the fan.

Using a Winterfront**CAUTION**

The use of a winterfront can result in excessive coolant, engine oil, and intake air temperatures, which may lead to overheating and possible engine damage.

**CAUTION**

A winterfront should only be used at temperatures below 40°F (4°C). Use

of a winterfront above 40°F (4°C) can decrease life of cooling module components. Remove winterfront as soon as the ambient temp reaches 41°F (5°C). The use of a winterfront above 40°F (4°C) can result in excessive coolant, engine oil, and intake air temperatures, which may lead to overheating and possible engine or coolant module damage and emissions non-compliance.

The winterfront is designed to minimize the temperature differences across the radiator and reduce the possibility of cooling module damage. Aftermarket winterfronts may not provide the proper airflow distribution and could cause cooling module damage.

How to Set the Shutdown Timer

The Shut Down Timer must first be enabled. Enabling the shutdown timer is located in the Settings Sub-menu. Follow these steps to turn on the engine idle shutdown timer. The shutdown timer will default to 5 minutes (or the last value used) and can be set up to 30 minutes unless limited by the Engine Shutdown System ([Clean Idle](#) on page 290)

**WARNING**

Never idle your vehicle for prolonged periods of time if you sense that exhaust fumes are entering the cab. Investigate the cause of the fumes and correct it as soon as possible. If the vehicle must be driven under these conditions, drive only with the windows open. Failure to repair the source of the exhaust fumes may result in death, personal injury, equipment or property damage.

**CAUTION**

DO NOT idle the engine for excessively long periods. Long periods of idling, more than 10 minutes, can cause poor engine performance.

1. Using the **Scroll Wheel**, target the number of minutes and press **Select**.
2. **Back** to return to the Settings menu.

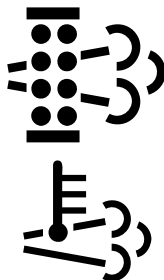
What is Engine Aftertreatment

Vehicles manufactured with diesel engines have an Engine Aftertreatment System (EAS) to control vehicle exhaust emissions. The system consists of a Diesel Particulate Filter (DPF), Selective Catalytic Reduction (SCR), DPF Switch and warning lights. The DPF will trap soot from the engine exhaust gases. The SCR uses Diesel Exhaust Fluid to reduce the levels of NOx in the engine exhaust. The EAS will periodically clean (regenerate) the DPF. Please refer to the Engine Aftertreatment System Supplement provided with the vehicle for more detailed description of functionality and warnings.

Transmission**Transmission Tips****Riding the Clutch**

The clutch is not a footrest. DO NOT drive with your foot resting on the clutch pedal. It will allow your clutch to slip, causing excessive heat and wear, damage could result.

Release Bearing Wear

When you must idle your engine for any period of time, shift your transmission to neutral and disengage the clutch (take your foot OFF of the pedal). This helps prevent unnecessary wear to your clutch release bearing, and is less tiring for you, too.

More Tips

- Always use the clutch when making upshifts or downshifts.
- Always select a starting gear that will provide sufficient gear reduction for the load and terrain.
- Never downshift when the vehicle is moving too fast.

- Never slam or jerk the shift lever to complete gear engagement.
- Never coast with the transmission in neutral and the clutch disengaged. To provide smooth gear engagements while shifting, use proper coordination between shift lever and clutch.
- Double clutching is a very effective means to increase the service life of your transmission. Double clutching refers to a technique where the clutch pedal is used twice per shift instead of once. It also requires that you adjust the engine rpm in the middle of the shift which ultimately synchronizes the gears during shifting. Synchronizing reduces wear on the gears.

Operating Manual Transmissions

The transmission shift pattern for your vehicle may be located on the shift control knob. In addition to understanding the shift pattern and its location, you should read the transmission manufacturer's manual provided with your vehicle before operating the vehicle. After making sure the vehicle's oil and air pressure are correct and all

other parts and systems are in proper working condition:

1. For vehicles with a clutch pedal, locate the clutch pedal and engage the clutch brake.
2. Shift into a low gear.



CAUTION

Always use first gear or a low speed range to start the vehicle in motion. The use of a higher gear or speed range forces undue strain on the engine, clutch, and other transmission components, and may cause damage.

3. Evaluate the road surface conditions and terrain your vehicle is on. Select a gear low enough to let your vehicle start forward with the throttle at idle.
4. Push the parking brake valve handle (yellow) against the dash panel to release the brakes.
5. Release the clutch pedal (manual only), then gradually accelerate to permit smooth starting.
6. DO NOT allow your vehicle to roll (even a little) in the opposite direction during clutch

engagement. If you need to start up on an incline, apply your service brakes before you release the parking brake. Then release your service brakes as you engage the clutch and apply throttle.

For further instructions on operating your transmission, see the transmission manufacturer's Driver/Operator's Instruction Manual.

If you want to shift directly into any gear other than first or reverse, depress the clutch pedal only far enough to release the clutch. Fully depressing the pedal applies the clutch brake and could cause gear hang-up.

If you have a misaligned gear condition in your vehicle's transmission and cannot start, gradually release the clutch, allowing the drive gear teeth to line up properly. Then the drive gear can roll enough to allow the teeth to line up properly and complete the shift. The best engine performance and maximum economy is obtained if gears are properly selected. This efficiency is achieved by always selecting gears within optimum engine rpm, which is where maximum torque and power are obtained. Shift carefully in a new vehicle. The transmission may be a little stiff at first.

Avoid gear clashing, by closely following these procedures. When you are operating a new vehicle or one that has been exposed to cold weather, you want the transmission lubricant (fluid) to circulate and coat the contacting surfaces of the gears. Metal contacting metal in moving parts may seriously damage your transmission, do not drive in one gear for long periods of time until the transmission lubricant has a chance to coat all contacting surfaces.

- Always select a starting gear that will provide sufficient gear reduction for the load and terrain.
- Never downshift when the vehicle is moving too fast.
- Never slam or jerk the shift lever to complete gear engagement.
- Never coast with the transmission in neutral and the clutch disengaged.

How to Use the Hydraulic Clutch



CAUTION

Be careful not to apply the clutch brake while the vehicle is moving. The

purpose of the clutch brake is to stop the transmission so that you can shift into a starting gear without grinding gears. Applying the clutch brake when the vehicle is moving causes a braking effect on the drivetrain and shortens the service life of the clutch brake.



CAUTION

DO NOT push the clutch pedal completely to the floor when shifting while the vehicle is in motion. using the clutch brake while shifting a vehicle in motion will damage the clutch brake. A non functioning clutch brake will make shifting very difficult when the vehicle is stationary.

1. Depress the clutch pedal past the first 1/2 in. (13 mm) for approximately 5 1/2 in. (139.7 mm) of total pedal travel.
2. Depress the clutch pedal another 1/2 in. (13 mm) to engage the clutch brake.

The clutch brake is used for stopping transmission gears, allowing you to easily shift into first gear or reverse without

grinding gears. The clutch brake is not necessary when shifting into other gears while in motion.

If the clutch pedal is pressed completely to the floor and the transmission is not shifting, then it is time to have the clutch adjusted or serviced.

If the transmission has a butt-tooth condition and you cannot engage a gear, gradually release the clutch. Then the drive gear can roll enough to allow the teeth to line up properly and complete the shift. The clutch is not a footrest. Do not drive with your foot resting on the clutch pedal. It will allow your clutch to slip, causing excessive heat and wear, damage could result.

When you must idle your engine for any period of time, shift your transmission to neutral and disengage the clutch (take your foot OFF of the pedal). This helps prevent unnecessary wear to your clutch release bearing, and it is less tiring for you, too.

- Always use the clutch when making upshifts or downshifts.
- Never coast with the transmission in neutral and the clutch disengaged.
- To provide smooth gear engagements while shifting, use

proper coordination between shift lever and clutch.

How to Shift Using Double Clutch Method

Double clutching is easier on the transmission and on the engine, helping match your vehicle's engine speed with driveline speed to achieve clash-free shifts. The manual transmission in your vehicle is not equipped with gear synchronizers. Whether you are upshifting or downshifting, it is best to double clutch. To double clutch:

1. Push the clutch pedal down to disengage the clutch.
2. Move the gear shift lever to neutral.
3. Release the pedal to engage the clutch. This lets you control the rpm of the transmission mainshaft gears, allowing you to match the rpm of the mainshaft gears to those of the output shaft.
 - a. Upshifts: let the engine and gears slow down to the rpm required for the next gear.
 - b. Downshifts: press accelerator, increase engine and gear speed to the rpm required in the lower gear.

4. Now quickly press the pedal to disengage the clutch and move the gear shift lever to the next gear speed position.
5. Release the pedal to engage the clutch.

Automatic Transmissions

An automatic transmission makes shifting much easier. It remains important to completely understand how to operate the transmission to optimize its efficiency. Please read the manual for your automatic transmission included with your vehicle.



WARNING

DO NOT leave the cab of your vehicle without applying the parking brake. The truck could roll and cause an accident resulting in death or personal injury. Always apply the parking brake before you leave the cab.

Auxiliary Transmission

If you have an auxiliary transmission, see your transmission manufacturer's manual for its proper operation.

Brakes

Air Brake System



WARNING

DO NOT drive through water deep enough to wet brake components, as it may cause the brakes to work less efficiently than normal. The vehicle's stopping distance may be longer than expected, and the vehicle may pull to the left or right when brakes are applied, which could contribute to an accident involving death or personal injury.

Compressed air is delivered to the brake system through the valve at the brake pedal and is controlled with various valves and braking circuits. The brake system is designed with separate front, rear, and (when applicable) trailer circuits so that if one circuit is compromised and loses air, the other circuits will not be affected. Safety valves in each circuit will protect the other circuits in the event that a circuit loses air.

The air compressor on the engine will typically provide 100-130 psi (690-896 kPa) to the air tanks. The vehicle is also designed with an air dryer, which removes moisture from the compressed air in order to protect all components in the air system. The brake system may be further enhanced by additional devices such as brake proportioning valves, antilock braking systems, or sensors designed to let you know if your brake pads need to be serviced. Certain conditions may result in the brake surfaces getting wet. Brake surfaces that are wet do not perform as well as when they are dry. There may be situations where wet brake surfaces cannot be avoided. In such situations, apply the brakes while in motion, to dry the brake surfaces.

Certain conditions may result in your brake surfaces becoming overheated (above 800°F or 427°C). Overheated brakes will damage linings and drum surfaces, ultimately decreasing brake performance. Refer to Retarders and Descending a grade to avoid overheating the brakes.

Parking Brake

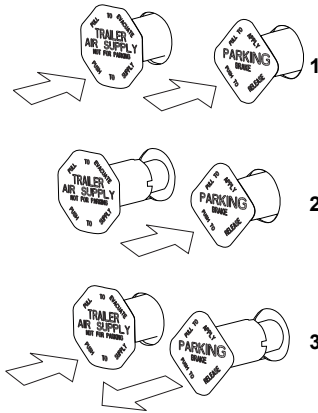

1. Normal run position
2. Trailer park with vehicle released
3. System park or trailer charge with vehicle parked

Parking brakes work in reverse action of the regular brakes. When the parking brakes are engaged, air is exhausted from the spring chambers, which allows the spring to engage the brakes. This design also provides a safety function if a brake

circuit has a leak and loses air. In such a scenario, the parking brakes will apply. The vehicle's parking brake controls are the yellow diamond shaped knob on your dash board. If the vehicle is equipped to tow a trailer, then there will be an additional red octagon shaped knob for the trailer parking brakes. Parking brakes will be engaged when either of these knobs are pulled OUT. (If one knob is pulled out, the other knob will automatically pop out.) Pushing IN a knob will disengage the respective parking brakes. If you push in the yellow knob only, you will disengage the vehicle's parking brakes but will not disengage the trailer parking brakes (if applicable). Either knob will pop back out if the system pressure is not above 60 psi (414 kPa). The instrument panel display will provide a message any time the parking brakes (vehicle or the trailer) are set and the vehicle is put into motion.

Engage Trailer Hand Brakes

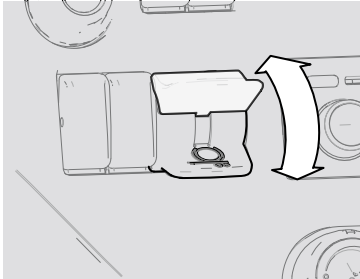

Press the lever down to engage the Trailer Hand Brakes. Push the lever back up to release the Trailer Hand Brakes.

Automatic Traction Control



Your truck/tractor ABS is equipped with an automatic traction control (ATC) feature. This feature is controlled by a switch on the dash. Do not allow the traction control lamp to remain on continuously for an extended length of time. Extended continuous use of the ATC can cause overheating of the drive wheel brakes. Engine torque or vehicle

speed should be reduced to eliminate wheel spin and prevent excessive application of the ATC system. Except for checking for proper illumination of the ABS and traction control warning lamps when first starting the vehicle, and for monitoring these lamps while driving, no special operating procedures are required. For detailed system description, see literature for your specific ABS that was provided with your vehicle.

Antilock Brake Systems (ABS)

This vehicle may be equipped with an ABS, which reduces the possibility of wheel lock-up. If a wheel is about to lock during braking, the ABS will automatically adjust air pressure to the brake chambers on the appropriate wheel(s) to prevent wheel lock-up. The ABS is automatically turned on when the ignition switch is turned on.



WARNING

The antilock brake system is a critical vehicle safety system. For the safety of you and others around you, have the vehicle submitted for periodic preventive maintenance checks as well as

having any suspected problems immediately checked by an authorized dealer. Failure to properly maintain your brake system can lead to serious accidents. Failure to comply may result in property damage, personal injury, or death.



WARNING

DO NOT rely on an antilock brake system that is functioning improperly. You could lose control of the vehicle resulting in a severe accident, causing personal injury or death. If your ABS lamp goes on while you are driving or stays on after the self-check, your anti-lock system might not be working. The ABS may not function in an emergency. You will still have conventional brakes, but not antilock brakes. If the lamp indicates a problem, have the ABS checked.

Vehicles without ABS are typically equipped with a bobtail brake proportioning system. When a trailer is not connected, the drive axle brake application pressure will automatically be limited by the proportioning system. When driven in a

bobtail mode, these tractors will require greater brake pedal application to provide the equivalent braking to a bobtail tractor not equipped with a proportioning system.

Trailer ABS Power Line Communication (PLC)

North American on-highway vehicles are equipped with a separate electrical circuit to power the ABS on towed vehicle(s). In most cases, the ABS power will be supplied through the Auxiliary circuit on the primary 7-way trailer light line connector. If the vehicle was manufactured with a switchable Auxiliary circuit for trailer accessories, an additional 7-way connector would have been provided for trailer ABS power. In either case, the ABS power line on the vehicle will be PLC equipped.



CAUTION

DO NOT splice into the non-switchable Auxiliary circuit on the primary 7-way trailer light line. Doing so may cause the trailer ABS to malfunction. This circuit is dedicated for trailer ABS power. To add a switchable auxiliary circuit, contact a dealership.



NOTE

Tractors/Trucks and trailers built after 03/01/2001 must be able to turn on an In-Cab Trailer ABS Warning Light (per U.S. FMVSS121). The industry chose Power Line Communication (PLC) as the standard method to turn it on. On trailers built prior to 03/01/2001 verify trailer ABS system status via the required external warning light mounted on the trailer. The indicator light on the trailer should be yellow and identified with the letters ABS.

For doubles or triples, the lamp does not distinguish between trailers. An ABS problem in any of the trailers will activate the Trailer ABS Warning Lamp. If you change the intended service in any way (e.g., number of axles, multiple trailers, add switchable trailer accessories, etc.) from the date the vehicle was manufactured, you should contact your trailer manufacturer and/or trailer antilock brake manufacturer to determine if the power available at the 7-way trailer light line is adequate. Failure to do so might result in insufficient power to the trailer

ABS system, which may affect its operation.



CAUTION

The center pin of the 7-way trailer light line may be constantly powered for ABS. Make sure it will not accidentally turn on trailer equipment.

Special Trailer ABS Without PLC (Option)

If a trailer does not have PLC, but it does have ABS that is powered through an optional second trailer connector (ISO 3731) and that trailer ABS is designed to control the Trailer ABS Warning Lamp in the cab and the vehicle has been ordered with the option to turn on this lamp for these types of trailers, then this lamp will turn on when that trailer ABS has a system problem. This should be checked by a dealer as soon as possible. The Trailer ABS Warning Lamp will not turn on for the power-on test when connected to these types of trailers.

**NOTE**

Very few trailers built before 03/01/2001 have this option. Trailers built after 03/01/2001 are built with PLC technology.

Advanced ABS with Stability Control

Advanced ABS with Stability Control is a feature that reduces the risk of rollovers and other loss of control situations. For vehicles towing trailers, the feature can reduce the risk of a trailer jackknifing. During operation, the system constantly compares performance models to the vehicle's actual movement, using the wheel speed sensors of the ABS system, as well as lateral, yaw, and steering angle sensors. If the vehicle shows a tendency to leave an appropriate travel path, or if critical threshold values are approached, the system will intervene to assist the driver.

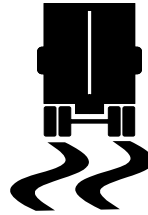

Electronic Stability Control may reduce the vehicle speed automatically. To minimize unexpected deceleration and reduce the risk of a collision the operator must:

- Avoid aggressive driving maneuvers, such as sharp turns or abrupt lane changes at high speeds, which might trigger the stability system.
- Always operate the vehicle safely, drive defensively, anticipate obstacles and pay attention to road, weather, and traffic conditions. ABS, ATC, and ESC stability systems are no substitute for prudent, careful driving.

Roll Stability

A Real World Example of How the System Operates

Excessive speed for road conditions creates forces that exceed the threshold at which a vehicle is likely to roll over on a higher-friction surface. The system automatically reduces engine torque and applies the service brakes (based on the projected rollover risk) to reduce the vehicle speed, thereby reducing the tendency to roll over.

Roll Stability Example

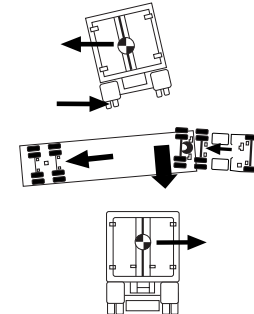

Yaw Stability

Yaw stability counteracts the tendency of a vehicle to spin about its vertical axis.

During operation, if the friction between the road surface and the tires is not sufficient to oppose lateral (side) forces, one or more of the tires can slide, causing the truck/tractor to spin. These yaw events are referred to as either "under-steer" (where there is a lack of vehicle response to steering input due to tire slide on the steer axle) or "over-steer" (where the tractor's rear end slides out due to tire slide on the rear axle) situation. Generally, shorter wheelbase vehicles (tractors, for instance) have less natural yaw stability, while longer wheelbase vehicles (straight trucks, for instance) have greater natural yaw stability. Factors that influence yaw stability are: wheelbase, suspension, steering geometry, weight distribution front to rear, and vehicle track width.

Yaw Control

Yaw Control responds to a wide range of low- to high-friction surface scenarios including rollover, jackknife and loss of control. In the case of vehicle slide (over-steer or understeer situations), the system will reduce the throttle and then brake one or more of the "four corners" of the vehicle (in addition to potentially applying the trailer brakes), thus applying a counter-force to better align the vehicle with an

appropriate path of travel. For example, in an over-steer situation, the system applies the "outside" front brake; while in an under-steer condition, the "inside" rear brake is applied.

A Real World Example of How Yaw Control Operates

Excessive speed exceeds the threshold, creating a situation where a vehicle is likely to spin and, where applicable, jackknife. The system reduces engine throttle and selectively applies brakes to reduce the vehicle speed, thereby reducing the tendency to jackknife.

Yaw Control Example

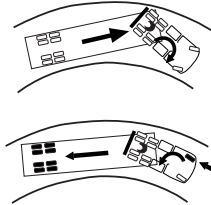

Automatic Traction Control



Your truck/tractor ABS has an automatic traction control (ATC) feature. This feature is controlled by a switch. This feature is monitored by a warning lamp located on the switch. The Traction Control warning lamp will briefly illuminate and then go out when the ignition switch is first turned on. The traction control warning lamp will illuminate whenever the ATC system detects drive wheel spin. The lamp will remain illuminated as long as wheel spin is detected and the ATC system is applying the drive wheel brakes or reducing engine torque. Engine torque or vehicle speed should be reduced to eliminate wheel spin and prevent excessive application of the ATC system.

Except for checking for proper illumination of the ABS and traction control warning lamps when first starting the vehicle, and for monitoring these lamps while driving, no special operating procedures are required. For detailed system description, see literature for your specific ABS that was provided with your vehicle.

This feature helps improve traction when vehicles are on slippery surfaces or surfaces with poor traction (i.e. mud or snow) by reducing drive wheel overspin. Automatic traction control works automatically in two different ways:

- If a drive wheel starts to spin, ATC applies air pressure to brake the wheel. This transfers engine torque to the wheels with better traction.
- If all drive wheels spin, ATC reduces engine torque to provide improved traction.

ATC turns itself on and off, you do not have to select this feature. If drive wheels spin during acceleration, the ATC Warning Lamp comes on, indicating wheel spin control is active. Do not allow the ATC Warning Lamp to remain on continuously for an extended length of time. Extended, continuous use of the ATC can cause overheating of the drive wheel brakes.

Deep Snow and Mud Switch

A deep snow and mud switch is included with Automatic Traction Control (ATC). The Deep Snow and Mud feature is helpful during acceleration. This function increases available traction on extra soft surfaces like snow, mud, or gravel, by slightly increasing the permissible wheel

spin. When this function is in use, the ATC Warning Lamp blinks continuously.

Off-Road ABS Function Switch (Optional)

Your vehicle may be equipped with a separate switch to activate an Off-Road ABS function. This function is NOT to be used for On-Highway driving but is intended to be used to improve stopping performance in Off-Highway conditions (e.g., loose gravel and mud). The Off-Road ABS function is accomplished by allowing a "wedge" of material to build-up in front of momentarily locked wheels.

- Changes the ABS control limits to allow for a more aggressive ABS function while off-road.
- Improves vehicle control and helps reduce stopping distances in off-road conditions or on poor traction surfaces such as loose gravel, sand, and dirt.
- Allows retarders to function independently of the ABS function.
- If your vehicle does not have an engine retarder, the Off-Road ABS switch will function the same.



WARNING

While the off road mode can improve vehicle control and shorten stopping distances, some steering ability may be reduced on certain surfaces resulting from the momentarily sliding tires. Always operate your vehicle at safe operating speeds. Failure to do so may cause you to lose control of the vehicle and could result in an accident or personal injury.



CAUTION

Never drive your vehicle on improved roads/highways with the Off-Road ABS function turned on. When you drive your vehicle onto an improved road surface or highway, immediately turn off the Off-Road ABS switch. Failure to do so will cause the ABS system to not function properly in an ABS event under 25 mph (40 km/h) and could result in an accident or personal injury.

The ABS lamp flashes slowly during off-road mode engagement. This is done to alert you of a modification to the ABS control software. At speeds above 25 mph (40 km/h), the ABS controller operates in the normal on-highway mode. At speeds between 10 and 25 mph (16 and 40 km/h), the ABS control software is modified to allow short periods (0.25 seconds) of locked-wheel cycles. At speeds below 10 mph (16 km/h), the ABS control software is turned off to allow locked wheels. When the Off-Road ABS function is enabled, the Retarder Disable output is turned off. That is, the engine retarders are left to function without ABS intervention. For additional information, see the Off-Road ABS pamphlet in your vehicle's glove box.

Effectiveness and Limitations

ESC is designed and optimized for trucks and for tractors that tow single trailers. If a tractor equipped with ESC is used to power multiple trailer combinations (known as "doubles" or "triples") the effectiveness of the ESC system may be greatly reduced.



WARNING

Exercise extreme care when towing doubles or triples with a vehicle equipped with Electronic Stability Program. Excessive speed and aggressive maneuvers, such as sharp turns, sudden steering inputs or abrupt lane changes should be avoided because these maneuvers could cause loss of vehicle control possibly resulting in an accident involving death or personal injury.

Additionally, the ESC stability system's effectiveness may be greatly reduced if:

- The load shifts due to improper retention, accident damage or the inherently mobile nature of some loads (for example, hanging meat, live animals or partially laden tankers).
- The vehicle has an unusually high or offset center of gravity (CG).
- One side of the vehicle drops off the pavement at an angle that is too large to be counteracted by a reduction in speed.
- The vehicle is used to haul double or triple trailer combinations.

- If very rapidly winding steering inputs are inputted at high speeds.
- There are mechanical problems with suspension leveling of the tractor or trailer resulting in uneven loads.
- The vehicle is maneuvering on a high banked road creating either additional side forces due to the weight (mass) of the vehicle or a deviation between expected and actual yaw rates.
- Gusty winds are strong enough to cause significant side forces on the vehicle and any towed vehicles.

To maximize the effectiveness of ESC:

- Loads must be properly secured and evenly distributed at all times.
- Drivers need to exercise extreme caution at all times, and avoid sharp turns, sudden steering inputs or abrupt lane changes at high speeds, particularly if:
 - The vehicle hauls loads that could shift
 - The vehicle or load has a high or offset center of gravity (CG) when loaded
 - The vehicle tows doubles or triples

The ESC system was specifically calibrated and validated only for your vehicle's original factory-built configuration. If your vehicle's chassis components are altered (for example; a wheelbase extension or reduction, tag axle addition or removal, tractor to truck conversion or steering system component change) the ESC system must be disabled immediately by a qualified mechanic.

**WARNING**

Failure to disable ESC "Electronic Stability Control" when modifying a vehicle could result in a loss of vehicle control possibly resulting in an accident involving death or personal injury.

**WARNING**

For vehicles equipped with ESC (Electronic Stability Control) do not replace the vehicle's steering wheel with an aftermarket or different part number than originally supplied. Using a different steering wheel could cause ESC to malfunction causing a loss of vehicle

control possibly resulting in an accident involving death or personal injury.

Whenever maintenance or repair work is performed to the steering mechanism, linkage, gear, adjustment of the wheel track, or if the steering angle sensor is replaced or the steering wheel is changed or re-centered, the Steering Angle Sensor must be re-calibrated.

**WARNING**

If the Steering Angle Sensor is not recalibrated, the Yaw Control system will not function properly. An uncalibrated sensor could result in a loss of control of your vehicle which can lead to an accident involving death or personal injury.

Towing Doubles Or Triples May Reduce The Effectiveness Of Stability Systems

ESC is designed and optimized for trucks and for tractors that tow single trailers. If a tractor equipped with ESC is used to power multiple trailer combinations (known as

"doubles" or "triples") the effectiveness of the ESC system may be greatly reduced.

**WARNING**

Exercise extreme care when towing doubles or triples with a vehicle equipped with Electronic Stability Program. Excessive speed and aggressive maneuvers, such as sharp turns, sudden steering inputs or abrupt lane changes should be avoided because these maneuvers could cause loss of vehicle control possibly resulting in an accident involving death or personal injury.

Additionally, the ESC stability system's effectiveness may be greatly reduced if:

- The load shifts due to improper retention, accident damage or the inherently mobile nature of some loads (for example, hanging meat, live animals or partially laden tankers).
- The vehicle has an unusually high or offset center of gravity (CG).
- One side of the vehicle drops off the pavement at an angle that is too large to be counteracted by a reduction in speed.

- The vehicle is used to haul double or triple trailer combinations.
- If very rapidly winding steering inputs are inputted at high speeds.
- There are mechanical problems with suspension leveling of the tractor or trailer resulting in uneven loads.
- The vehicle is maneuvering on a high banked road creating either additional side forces due to the weight (mass) of the vehicle or a deviation between expected and actual yaw rates.
- Gusty winds are strong enough to cause significant side forces on the vehicle and any towed vehicles.

To maximize the effectiveness of ESC:

- Loads must be properly secured and evenly distributed at all times.
- Drivers need to exercise extreme caution at all times, and avoid sharp turns, sudden steering inputs or abrupt lane changes at high speeds, particularly if:
 - The vehicle hauls loads that could shift
 - The vehicle or load has a high or offset center of gravity (CG) when loaded

- The vehicle tows doubles or triples

The ESC system was specifically calibrated and validated only for your vehicle's original factory-built configuration. If your vehicle's chassis components are altered (for example; a wheelbase extension or reduction, tag axle addition or removal, tractor to truck conversion or steering system component change) the ESC system must be disabled immediately by a qualified mechanic.



WARNING

Failure to disable ESC "Electronic Stability Control" when modifying a vehicle could result in a loss of vehicle control possibly resulting in an accident involving death or personal injury.



WARNING

For vehicles equipped with ESC" Electronic Stability Control" do not replace the vehicle's steering wheel with an aftermarket or different part number than originally supplied. Using a different

steering wheel could cause ESC to malfunction causing a loss of vehicle control possibly resulting in an accident involving death or personal injury.

Whenever maintenance or repair work is performed to the steering mechanism, linkage, gear, adjustment of the wheel track, or if the steering angle sensor is replaced or the steering wheel is changed or re-centered, the Steering Angle Sensor must be re-calibrated.



WARNING

If the Steering Angle Sensor is not recalibrated, the Yaw Control system will not function properly. An uncalibrated sensor could result in a loss of control of your vehicle which can lead to an accident involving death or personal injury.

Retarders

Various retarders are available, which function against the engine, driveline, or transmission. These are devices that use your engine's power to slow down your

vehicle. They reduce brake wear and tear and the need for continuous brake use, which can lead to your service brakes overheating. Ideally, you should always slow your vehicle with your retarder (where permitted by law) and use your service brakes only for stopping completely. Operating this way will greatly prolong the life of your brakes.

**WARNING**

DO NOT use any of the vehicle's retarders in any situation that requires an immediate stop and/or in situations of poor traction (such as wet, icy, or snow covered roads). Trying to use the retarder instead of the service brakes may cause a loss of vehicle control, which may result in an accident involving death or personal injury.

**WARNING**

The service brakes must be used in an emergency. The retarder alone might not stop you fast enough to prevent an accident. Failure to comply may result

in death, personal injury, equipment or property damage.

The retarder is NOT intended as the primary brake for the vehicle, nor is it an emergency brake. The retarder only helps the service brakes by using pressure to slow the drivetrain. Use the service brakes for quick stops. Do not use the retarder when operating on road surfaces with poor traction (such as wet, icy, or snow covered roads or gravel). Retarders can cause the wheels to skid on a slippery surface. We recommend that you do not use your engine retarder to slow down when you are bobtailing or pulling an empty trailer.

**WARNING**

Using an engine retarder can cause a wheel lockup. The trailer is not loading the tires enough to give the traction you may need. When you are bobtail or unloaded, you can have a serious accident if your wheels lock suddenly during braking. You could be killed or injured. DO NOT use your retarder when you are driving bobtail or with an unloaded trailer.

This vehicle may have a transmission retarder. Take your foot off the throttle and operate the retarder switch. When you do not need full retarder effect, you can apply it intermittently (off and on) to cause gradual or partial slowing. Continuous application of your retarder will cause your hydraulic fluid to get hotter. Intermittent application will help prevent overheating.

**WARNING**

DO NOT rely on your automatic transmission hydraulic retarder to stop your vehicle. If your engine shuts down, the vehicle's retarder will cease to operate which may lead to an accident involving death or personal injury. Always be ready to suddenly apply the service brakes.

Axle and Suspension

Differential Lock



The vehicle may be equipped with switches to lock the either of the rear axle differentials. Depending on how the vehicle is specified, a combination of individual switches may be available that can lock the interaxle driveline and/or any combination of the forward rear or rear-rear driving axles. The interaxle differential switch allows each axle to turn independently. In certain situations, engaging the interaxle differential lock relieves stress on the rear axles and reduces tire wear. Engaging this switch will also provide better traction in slippery or loose gravel conditions. In the LOCK position, continuous operation on paved, dry surfaces, put stress on the axles, and can possibly damage the internal gears. The switch has a guard to prevent accidental operation of the switch. Locking the differentials is typically used during ice or snow conditions and without tire chains, unpaved roads that have loose

sand, mud or uneven surfaces. Look ahead and predict when the differential needs to be locked. Stop the vehicle and lock the differentials before approaching. While using the differential in the locked position, do not exceed 25 mph (40 km/h). When disengaging the differential lock, reduce the throttle to prevent drivetrain damage.



WARNING

DO NOT put the differential lock in the LOCK position while the wheels are spinning freely (slipping), you could lose control of the vehicle or cause axle damage. Switch to LOCK only when the wheels are not spinning. Failure to comply may result in death, personal injury, equipment or property damage.

Dual Range (Two-Speed) Rear Axle



Your vehicle may be equipped with a two-speed or dual range axle (option). The low range provides maximum torque for hauling heavy loads or traveling over rough terrain. The high range is a faster ratio for highway speeds and general over-the-road conditions. A switch on the accessory switch panel controls the dual range rear axle. You will notice that the switch has a guard to protect you from activating it accidentally. Always park your vehicle with the range selector in LOW.

Important tips on operating a dual range axle with inter-axle differential:

- Shift the axle with the inter-axle differential in the unlocked position only.
- When you are driving with poor traction, lock the differential. When you have the differential locked, drive with the axle in LOW range only.
- When you are driving on a surface with good traction, keep the inter-axle differential unlocked. You can drive with the axle in the LOW or HIGH range.
- Always UNLOCK the inter-axle differential before shifting the axle speed range.

**WARNING**

Never shift the axle when moving downhill. Engine driveline disengagement may occur, eliminating engine retardation and allowing the wheels to spin faster than the current speed of the engine. This may require severe braking to slow the vehicle down and can result in an accident. Failure to comply may result in death, personal injury, equipment or property damage.

**CAUTION**

If you shift the axle range with the inter-axle differential in LOCK, you could seriously damage the axles. Never shift the axle range with the differential locked.

Proper shifting of the axle depends on the synchronization of engine/driveline and wheel speed. When you shift the axle, the connection between the engine and wheels is momentarily disengaged while the gearing is synchronized. Normally when the axle is shifted the speed of the engine,

axle, and wheels adjust, allowing for proper gear engagement.

When going downhill the wheels will not slow down, but will tend to speed up, which makes gear synchronization almost impossible. As a result, the axle is neither in HIGH nor LOW range and all engine/driveline retardation is lost. Without engine retardation it is more difficult to slow the vehicle down and greater stress is put on the brake system.

**CAUTION**

To avoid damaging your vehicle shift the axle at slower travel speeds until you are used to driving with a dual range axle.

How to Operate Two-Speed Axle - Low to High

These steps should be used if operating a two-speed axle in LOW range on rough terrain and preparing to drive on an improved surface.

When you go from rough terrain to highway driving, shift the axle to the HIGH range following this procedure:

1. Be sure the differential is UNLOCKED.
2. Maintain your vehicle speed (accelerator depressed) and move the Range Selector lever to HIGH.
3. Keep driving with the accelerator depressed until you want the axle to shift.
4. To make the axle shift, release the accelerator until the axle shifts. You are now in the HIGH axle range for highway speeds. Shift the transmission normally to reach your desired cruising speed.

How to Operate Two-Speed Axle - High to Low

These steps should be used if operating a two-speed axle in HIGH range on improved roads and preparing to drive on rough terrain.

When you go from highway driving to rough terrain, shift the axle to the LOW range following this procedure:

1. Maintain vehicle speed (accelerator depressed) and move the Range Selector lever to LOW.
2. Keep driving with the accelerator depressed until you want the axle to downshift.

3. To make the axle downshift, release and depress the accelerator quickly to increase the engine rpm. The axle will shift to LOW range.
4. You are now in the LOW axle range for rough terrain and heavy loads. Shift the transmission normally to maintain the desired speed.

Auxiliary Axle

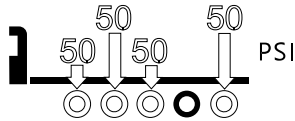

Adjustable auxiliary axles (commonly known as Pusher or Tag axles) can add to the productivity of the vehicle by increasing the load capabilities of the vehicle when they are in the deployed (down) position. There are different configurations of axles with different functionality (liftable versus steerable). Without the extra axle, the excessive weight can reduce the service life of vehicle components such as, but not limited to, the frame rail, axles, suspension and brakes.

Operation of the auxiliary axles includes the proper maintenance of the system and

calibration of its controls. Operating the auxiliary axles will also require a firm understanding of the Gross Axle Weight Rating (GAWR) and the load that is being carried.

The vehicle will have switches on the dash to control the position of the auxiliary axles. In certain situations, however, the system will override the controls to protect the axle system. For Self Steering Lift Axles, the axle will raise when the park brakes are applied or if the vehicle is placed in reverse. For Non-Steer Lift Axles, the axle will only automatically raise if the park brakes are applied and there are no park brakes on the lift axle. Non-Steer Lift Axles do not automatically raise when the vehicle is placed in reverse.

Operating the auxiliary liftable axles must be performed in a manner that does not exceed the axle creep rating. Axle creep ratings are weight and speed limits that are allowed while the vehicle is fully loaded (in excess of the vehicle's standard GAWR) and the axle is in its up position. Axle creep ratings are assigned by the axle manufacturer and are based on axle model and intended service of the vehicle. Contact an authorized dealership if you are unable to identify the axle creep rating of this vehicle.

- Liftable/steerable (axle lift calibration required)
- Liftable/non-steerable (axle lift calibration required)
- Non-liftable (some suspensions require dump valve calibration)

 WARNING
<p>DO NOT operate or park the vehicle with auxiliary axles in the down/loaded position when vehicle is unladen, or is being unloaded. Raise or dump air into driver controlled auxiliary axle(s) prior to unloading vehicle. Failure to do so can result in loss of vehicle control or roll-away that may result in personal injury, property damage or death.</p>

Auxiliary Axle Pressure Regulator

Vehicles with liftable auxiliary axles will have knobs available to adjust the pressure in the auxiliary axle suspension. These knobs are in addition to the tag and pusher axle switches that control the axle position.

Adding more pressure to the auxiliary axle will increase the pressure the auxiliary axle pushes down. Increasing pressure will

decrease load on the drive axles and will decrease traction. Decreasing pressure will transfer more weight to the drive axles and will result in more traction from the drive axles.

Deflate the auxiliary axle suspension before coupling or uncoupling a trailer. After the trailer is coupled or uncoupled, then increase pressure to balance traction and axle load requirements. Inflate air springs of the auxiliary axles to the desired pressure after coupling to a loaded trailer while still maintaining proper traction of the drive axles.

Adjust the pressure regulator control knob to a lower pressure until desired traction is obtained. By reducing air pressure at pusher or tag axle, load will be transferred to drive axles. Do not overload drive axles. Always deflate air springs of the auxiliary axles before attempting to unload vehicle. This allows maximum traction of the drive axles to control the vehicle.

Depending on the suspension, various calibrations may be required. Contact your authorized dealer or axle/suspension manufacturer for specific calibration procedures.

Some suspensions require dump valve calibration. For example, some dead axles do not lift, but the air can be dumped out of

them to unload them when empty. Air pressure is controlled via an adjustable regulator. These axles need to be calibrated for load.

Contact your authorized dealer or axle/suspension manufacturer for dump valve calibration procedures.

Axle Creep Rating

Vehicles outfitted with auxiliary axles and full truck configuration will have an axle creep rating which defines how much load is allowed when the vehicle has a full load and maneuvering the vehicle, at very slow speeds, with auxiliary axles in the up position. In these situations, the load exceeds the gross axle weight rating of the axles.

Operator's using vehicles equipped with liftable auxiliary axles must consider creep ratings when any liftable axle is unloaded or in the raised position. Liftable auxiliary axles should only be raised (or unloaded) to improve maneuverability in an off-road use or when vehicle is unloaded.



WARNING

NEVER operate the vehicle with more pressure in the lift axles than is neces-

sary to carry the load, as determined by the calibration procedure described. Failure to do so can result in loss of traction and stability at the steer and/or drive axles and can result in increased braking distance, which could cause loss of vehicle control resulting in an accident. Failure to comply may result in death, personal injury, equipment or property damage.



NOTE

Axle Creep ratings MUST NOT be exceeded.



CAUTION

Always lower the axles as soon as possible after receiving a load. Never exceed 5 mph (8 km/h) when driving with a load with the auxiliary axle(s) raised/unloaded. Failure to lower the axle(s) can overload the frame and remaining axles, and could cause equipment damage.



CAUTION

DO NOT modify the air system and/or control functionality on a factory installed auxiliary axle(s). Modifying the factory operation of the pusher and/or tag axle(s) will void your warranty, and can cause equipment damage.



CAUTION

A change in tire size on either the auxiliary axles or the drive/steer axles can change the calibration of the auxiliary axles. If tires are installed with a different loaded radius, the calibration procedure must be repeated. Failure to do so can cause equipment damage.

Contact your dealer or axle manufacturer to determine what the creep rating is for your particular axle(s) and configuration. Creep ratings are generally limited to the following:

- Tandem rear axles only
- Straight trucks only
- Maximum spring mount centers per axle manufacturers specifications

- Maximum tire static loaded radius (SLR) per axle manufacturers specifications

Pusher or Tag Suspension Calibration

Perform this procedure at or near a weight scale. Procedure can be performed while parked on the weight scale if scale is available. To obtain the desired axle load distribution, you must correlate the suspension air gauge pressure to the actual axle load by scaling the axle weight(s) and adjusting the pressure to obtain the desired load. Once the desired load or load range is achieved, document the pressure-to-load ratio or setting for future use.



NOTE

This procedure must be performed prior to placing the vehicle into service.

Add: Perform this procedure at or near a weight scale. Procedure can be performed while parked on the weight scale if scale is available.

Setting the Pressure-to-Load Ratio

To obtain the desired axle load distribution, you must correlate the suspension air gauge pressure to the actual axle load by scaling the axle weight(s) and adjusting the pressure to obtain the desired load. Once the desired load or load range is achieved, document the pressure-to-load ratio or setting for future use.

These instructions are general in nature. For more specific instructions, review the pusher or tag suspension manufacturers maintenance manual or contact the nearest authorized dealer.

1. Park the loaded vehicle on a level surface with the wheels blocked.
2. Release vehicles spring brakes. (Do not release for Lifiable/Non-Steerable pusher or tag axles)
3. Lower the pusher/tag axles with the **Axle Lift Control** flip valve. (For some non-lifiable axles, inflate air suspension)
4. Adjust the amount of load on each axle by turning the **Pressure Regulator** clockwise to increase the load, or counterclockwise to decrease the load. (The suspension manufacturer may publish pre-established Pressure-to-Load Ratio Pressure Settings to

- assist you in achieving an estimated ground load).
- After setting the pressure to obtain the desired axle load, verify proper ground loading with the weight scale.

**NOTE**

Exceeding local, state, or federal weight limits may result in citations. Contact your local commercial weight enforcement office for limits in your area.

**NOTE**

Steerable-pusher and/or tag axle(s) will raise when the transmission is shifted into reverse or when the parking brakes are applied.

Air Suspension Ride Height

Vehicles equipped with rear or front air suspensions have their ride height and axle (pinion) angle(s) preset at the factory. These are precision settings and should not be altered. Incorrectly adjusted ride

height may result in improper interaxle U-joint working angles. This can result in premature driveline wear and driveline vibration.

If it becomes necessary to reset the ride height, you may temporarily set it by following the next procedure. Proper ride height measurement and values are shown in the illustration and table below.

**CAUTION**

Completing this procedure will enable you to safely reach the nearest authorized dealer or repair facility to have ride height and pinion angle reset using the proper equipment and technique. Do this as soon as possible to avoid potential driveline damage.

**NOTE**

Suitable wheel chocks are at a minimum an 18-inch (46 cm) long 4x4.

- Park the vehicle, engage the parking brakes and clock the wheels.

- Locate the air suspension ride height valve.

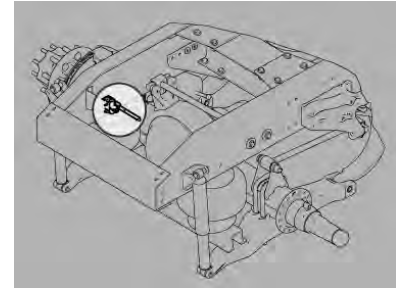

- Ensure that the tractor is fully laden during this procedure. Do not use these procedures on a vehicle that is not laden (bobtail).
- Ensure the air supply and delivery plumbing of the height control valve is consistent with the following illustrations.
- Loosen the fasteners mounting the height control valve to its bracket.

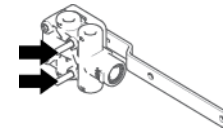

6. Rotate the valve either clockwise or counterclockwise until air pressure in the air springs provides the ride height specified for that suspension. Measure the ride height from the bottom of the frame rail to the approximate centerline of the rearmost drive axle hub:
 - For tandem axles, make the vertical measurement at the centerline of the suspension.
 - For a single axle, make the measurement in front of the axle, in the area forward of the tires but not past the suspension bracket.
7. When at the correct ride height, ensure that the height control valve lever is in the neutral position, then install either the built-in alignment pin or a 1/8 in. (3 mm) dowel.

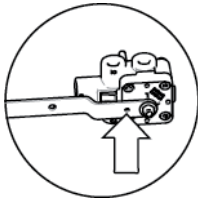

8. Torque the mounting fasteners to 55-75 lb-in. (6.2-8.5 N·m).
9. Remove the alignment pin or dowel.
10. Repeat Steps 2 through 6 above for the right-hand valve on vehicles with a dual-valve system.

Suspension Air Pressure Gauge & Switch



Your vehicle may have an air suspension and a deflation switch which allows the air in the suspension to be exhausted from a switch on the dash. The normal purpose of this feature is to allow you to lower the vehicle for loading. A guard on the switch prevents you from accidentally deflating the suspension.

The Suspension Air Pressure gauge (optional) indicates the amount of air pressure in the air suspension springs in pounds per square inch (psi). Air pressure in the spring is related to the rear axle load. The greater the rear axle load, the greater the air pressure in the air bags. Therefore,

the air pressure displayed will vary, depending upon the rear axle load.

Air Ride Height Data

These are factory settings for ride height of the rear air suspension.

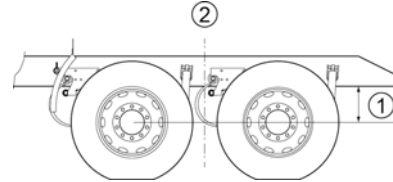

1. Ride height
2. Centerline of suspension

Single Axle	Laden Ride Height -in. (mm)
Air Trac	11.00 (279)
Low Air Leaf	6.50 (165)

Single Axle	Unladen Ride Height -in. (mm)
Air Trac	11.39 (289)
Low Air Leaf	6.75 (171)

Tandem Axle	Laden Ride Height - in. (mm)
Air Leaf	11.70 (297)
Air Trac	11.00 (279)
Low Air Leaf	8.50 (216)
Low Low Air Leaf	6.50 (165)
FLEX Air	8.50 (216)

Tandem Axle	Unladen Ride Height -in. (mm)
Air Leaf	12.0 (305)
Air Trac	11.38 (289)
Low Air Leaf	8.75 (222)
Low Low Air Leaf	6.75 (171)
FLEX Air	8.75 (222)

What to do if an Air Spring Ruptures

If an air spring has ruptured, drive the vehicle to a safe stop off the highway to investigate the problem.



WARNING

DO NOT continue to drive with ruptured air springs. The air loss can cause the spring brakes to apply allowing your brakes to drag and burn up the linings, which could lead to an accident causing death or personal injury. DO NOT continue to operate the vehicle in this condition.



WARNING

DO NOT drive the vehicle if the air pressure is less than 100 psi (690 kPa). Driving the vehicle with less than 100 psi (690 kPa) could make the brakes unsafe to use which could cause an accident involving death or personal injury.



CAUTION

Operating a vehicle with air suspension bags either overinflated or underinflated may cause damage to drive-

line components. If a vehicle must be operated under such conditions, do not exceed 5 mph (8 km/h). Failure to comply may result in equipment damage.

You can get to a repair facility by removing the height control link connected to the axle and to the suspension air valve control arm. This will cause the air valve control arm to center in the closed position. Removing the link will allow the air system of the truck to operate normally so that the vehicle can be driven to a service center.

Engine Aftertreatment System

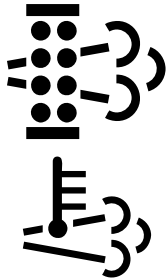

4

This vehicle has an Engine Aftertreatment System (EAS), to control vehicle exhaust emissions. The Engine Aftertreatment system consist of a Diesel Particulate Filter (DPF), Selective Catalyst Reduction (SCR), DPF Switch and warning lights. The DPF will trap soot from the engine exhaust gases. The SCR uses Diesel Exhaust Fluid to reduce the levels of NOx in the engine exhaust. The EAS will periodically clean (regenerate) the DPF.

Your vehicle may be equipped with an additional feature designed to alert a remote operator that the aftertreatment system requires a regeneration. When the

EAS detects a heavily loaded DPF it will sound the city horn for 10 seconds while continuously flashing the vehicle headlamps. The operator can resolve and reset the alert by performing a parked regeneration. Alternatively, the notification can be dismissed by pressing the clutch or the service brake. Dismissing the alert does not reset it, the next alert will occur at the next higher soot level if a parked regeneration is never performed.

Engine Aftertreatment System Detail

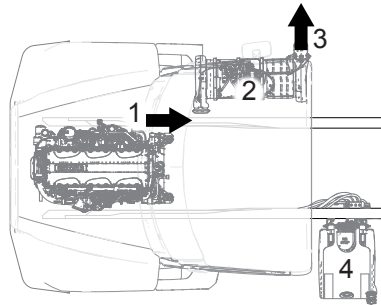

1. Hydrocarbon doser from turbo
2. Aftertreatment unit (DPF, DEF doser and SCR)
3. Filtered/treated exhaust
4. Diesel exhaust fluid (DEF) tank

Please refer to the Engine Aftertreatment System Supplement provided with the vehicle for more detailed description of functionality and warnings.

Trailer Operations

How to Lock the Kingpin

Ensure that the fifth wheel lock is in the unlocked position.



WARNING

Always inspect the fifth wheel for proper locking after coupling the tractor to a trailer. Failure to properly couple the tractor to a trailer (the kingpin is engaged in a closed lock jaw with the lock jaw secured by a closed plunger) may cause trailer separation which could result in an accident involving death or personal injury.

To lock the fifth wheel around the kingpin:

1. Ensure trailer brakes are locked and the landing gear is down.

- Back the tractor fifth wheel into the trailer kingpin to engage and lock.

JOST Fifth Wheel Indication



If equipped with JOST fifth wheel

- Pull the tractor forward to ensure the kingpin has been locked in place.
- Set the tractor parking brake.
- Connect the tractor brake air and electric lines to the trailer.

Conduct a pre-trip inspection prior to releasing the brakes, raising the landing gear, and driving the vehicle.

How to Release the Kingpin Remotely (option)



CAUTION

Do not deflate the rear suspension before unlocking the fifth wheel. Deflating

the rear suspension before unlocking the fifth wheel could cause difficulty during uncoupling and result in damage to the fifth wheel and kingpin.

- Set both the vehicle and trailer parking brakes.
- Lower the landing gear.
- Disconnect the tractor brake air and electric lines from the trailer.
- Flip up cover, then press and hold the **Kingpin Release** switch for 3 seconds. A countdown timer popup will appear on the display, and the unlock symbol on the **Kingpin Release** switch will illuminate. The popup will inform the operator when to release the switch.

JOST Fifth Wheel Indication



If equipped with JOST Fifth Wheel



NOTE

The fifth wheel will not unlock unless the vehicle is stopped and the parking brake is set. In this situation, a red-colored popup appears, informing the operator that kingpin release is not available and to set the parking brake. This will require restarting this procedure.

- Release the switch. The unlock symbol on the **Kingpin Release** switch will turn off.
- Ease tractor forward enough for the kingpin to clear the fifth wheel (about 12 to 18 inches).



NOTE

Do not drive tractor free of trailer.

- If the tractor has a rear air suspension, deflate (dump) the rear suspension enough so that the

fifth wheel will smoothly separate from the trailer.

Suspension Dump Symbol



8. Ease tractor forward, clearing the trailer.
9. If the rear suspension was deflated, return rear suspension to its normal height.

How to Release the Kingpin Manually



CAUTION

Do not deflate the rear suspension before unlocking the fifth wheel. Deflating the rear suspension before unlocking the fifth wheel could cause difficulty during uncoupling and result in damage to the fifth wheel and kingpin.



NOTE

The specific method required to operate the fifth wheel release handle will depend on the fifth wheel manufacturer and model. The operator should be familiar with this method prior to attempting this procedure.

To release the kingpin and separate tractor from trailer

1. Position the tractor and trailer in a straight line on firm, level ground.
2. Set both the tractor and trailer parking brakes.
3. Exit cab and lower the trailer landing gear.
4. Disconnect brake air and electric lines from trailer, and secure lines.
5. Unlock the fifth wheel release handle if necessary, then unlock the fifth wheel.



NOTE

Operating the release handle and unlocking the fifth wheel will depend on the fifth wheel manufacturer.

6. Return to cab and release tractor parking brake.
7. Ease tractor forward enough for the kingpin to clear the fifth wheel (about 12 to 18 inches).



NOTE

Do not drive tractor free of trailer.

8. If the tractor has a rear air suspension, deflate (dump) the rear suspension enough so that the fifth wheel will smoothly separate from the trailer.

Suspension Dump Symbol



9. Ease tractor forward, clearing the trailer.
10. If the rear suspension was deflated, return rear suspension to its normal height.

Air-Controlled Sliding Fifth Wheel (option)



Vehicles that have an air-controlled sliding fifth wheel have a fifth wheel slider lock controlled by a switch on the accessory switch panel. To operate this type of lock, move the switch to the appropriate position. By placing the switch in the **UNLOCK** position, you can slide the fifth wheel to various positions to adjust weight distribution. There is a guard on this switch to protect you against accidentally activating or releasing the lock.



WARNING

Do not move the fifth wheel while the tractor-trailer is in motion. Your load could shift suddenly, causing you to lose control of the vehicle, which can result in an accident. Never operate the vehicle with the switch in the **UNLOCK** position. Always inspect the fifth wheel after you lock the switch to be sure the fifth wheel lock is engaged. Failure to comply may result in

property damage, personal injury, or death.

How to Slide the Fifth Wheel



WARNING

DO NOT move the fifth wheel while the tractor-trailer is in motion. Your load could shift suddenly, causing you to lose control of the vehicle. Never operate the vehicle with the switch in the **UNLOCK** position. Always inspect the fifth wheel after you lock the switch to be sure the fifth wheel slide lock is engaged. Failure to comply may result in death, personal injury, equipment or property damage.



WARNING

Do not attempt to slide the fifth wheel until all persons and obstacles are clear of the vehicle.



NOTE

This procedure assumes a connected trailer. The trailer kingpin must be locked within the fifth wheel when changing slide positions.

1. Position the tractor and trailer in a straight line on firm, level ground.
2. Place the tractor in neutral, and set the tractor and trailer parking brakes.
3. Unlock the slide by repositioning the Fifth Wheel Slide switch.



CAUTION

Ensure the tractor and trailer brakes are engaged prior to sliding the fifth wheel. Failure to engage the brakes could result in uncontrolled sliding of the fifth wheel and possibly damage components on the tractor or trailer.

Fifth Wheel Slide Symbol



4. Inspect and verify that locking plungers have fully withdrawn from the fifth wheel slide tracks.
 - a. If locking plungers did not fully withdraw, move tractor slightly to reposition plungers and reinspect.
 - b. If plungers are still not fully withdrawn, lower the landing gear and deflate the rear suspension (if available) to lessen pressure on the slide.

Suspension Dump Symbol



5. Release the tractor parking brake, but keep the trailer brakes engaged.
6. Slowly ease tractor forward or backward, and stop at the desired position.
7. Lock the slide by returning the Fifth Wheel Slide switch to its previous position.
8. Inspect and verify that the locking plungers are fully inserted into the fifth wheel slide tracks.
 - a. If the locking plungers are not fully inserted in the track, move the tractor slightly to reposition plungers and reinspect.



WARNING

Do not operate the vehicle unless the locking plungers are

fully inserted into the fifth wheel slide track. Operating the vehicle while the plungers are not fully inserted could lead to the slide moving unexpectedly, resulting in a loss of vehicle control and potentially causing property damage, serious injury, or death.

9. If the landing gear was lowered, raise the landing gear.
10. If the rear suspension was deflated, return rear suspension to its normal height.

Driving Tips and Techniques

Coasting



WARNING

DO NOT coast with the transmission in neutral or with the clutch pedal depressed, it is a dangerous practice. Coasting in neutral may result in damage to your drivetrain when you try to re-engage the transmission. You could lose control of the vehicle which can lead to an accident involving personal injury or death.

Do not coast with the transmission in neutral or with the clutch pedal depressed. Besides being illegal and dangerous, coasting is also expensive. It causes premature failure or damage to the clutch and transmission and overloads the brake system. Coasting with the transmission in neutral also prevents proper transmission component lubrication. During coasting the transmission is driven by the rear wheels, and the countershaft gear (which lubricates the transmission components by oil splash) will only be turning at idle speed.

Descending a Grade



WARNING

DO NOT hold the brake pedal down too long or too often while going down a steep or long grade. This could cause the brakes to overheat and reduce their effectiveness. As a result, the vehicle will not slow down at the usual rate. To reduce the risk of an accident which could cause personal injury or death, before going down a steep or long grade, reduce speed and shift the transmission into a lower gear to help control your vehicle speed. Failure to follow procedures for proper downhill operation could result in loss of vehicle control.

Engine Overspeed



CAUTION

Do not let the engine RPM operate beyond the maximum governed RPM. Operating the engine above the maximum governed RPM may result in Engine damage.



NOTE

Often these recommendations are secondary to maintaining an adequate and safe speed relative to the surrounding traffic and road conditions.

Operate the engine within the optimum engine rpm range and do not allow the rpm's to exceed the maximum governed speed. See your Engine Operation and Maintenance manual for information regarding engine rpm. When the engine is used as a brake to control vehicle speed (e.g., while driving down a grade), do not allow the engine rpm to exceed maximum governed speed. Under normal load and road conditions operate the engine in the lower end of the range.

The tachometer is an instrument that aids in obtaining the best performance of the engine and manual transmission, serving as a guide for shifting gears. Refer to the Engine Operation and Maintenance manual for optimum engine rpm.

- If the engine rpm moves beyond the maximum governed speed, indicating an overspeed condition, apply the service brake or shift to a

- higher gear to bring engine rpm within the optimum speed range.
- When driving downhill: shift to a lower gear, use the engine brake (if so equipped), and use the service brake, keeping the engine speed below 2,100 rpm.

When the engine speed reaches its maximum governed speed, the injection pump governor cuts off fuel to the engine. However, the governor has no control over the engine rpm when it is being driven by the vehicle's transmission, for example, on steep downgrades. Apply service brakes or shift to a higher gear. Fuel economy and engine performance are also directly related to driving habits:

- The best results in trip time and fuel economy are obtained while driving the vehicle at a steady speed.
- Shift into higher or lower gears (or apply the service brake) to keep engine rpm near the lower end of the optimum operating range.
- Avoid rapid acceleration and braking.



WARNING

DO NOT look at the Digital Display for prolonged periods while the vehicle is moving. The Digital Display should be referenced only briefly and should not be used as a substitute for observing actual road and traffic conditions. Failure to pay attention to the vehicle's road position or situation can lead to an accident and possibly result in property damage, personal injury, or death.

Fuel Consumption

The vehicle's fuel consumption is connected to five important factors: maintenance, driving habits, general condition of the road, traffic conditions, and vehicle load.

Proper maintenance will keep the vehicle running like new even after long periods of use. The driver must perform daily and weekly checks of the vehicle.

Maintenance factors affecting fuel consumption:

- air and/or fuel filters partially clogged
- engine valves out of adjustment

- injection pump improperly synchronized
- injection nozzles defective or uncalibrated
- improperly inflated tires
- wheel bearings improperly adjusted
- clutch improperly adjusted or worn (slipping)
- fuel leaks

Wrong driving habits must be corrected and the recommendations on economic driving should be followed. Driving factors affecting fuel consumption:

- excessive speed and unnecessary fast acceleration
- long periods of idling
- driving with foot resting on the (manual transmission) clutch pedal

General Condition Other factors affecting fuel consumption are related to loads and type of roads on which the vehicle operates. It is not always possible to choose the most adequate road, but it must be kept in mind that the ideal road is the one that allows a steady speed in high gear, without requiring frequent braking and acceleration. The following general conditions can affect fuel consumption:

- overload

- unbalanced load
- very high load
- inadequate roads
- traffic conditions

Optimal Engine Speed Indicator

The tachometer displays a green bar just below the most efficient engine speed for the vehicle.

The placement and size of this bar is dependent on the engine as installed at the factory. The driver's general goal should be to select a gear that keeps the tachometer needle positioned over the green light as much as possible during steady state driving. In addition to proper maintenance and good driving habits, this visual cue can help minimize the fuel consumption.

Sleeper Bunks



WARNING

Always keep the lower bunk in its down (latched) position while the vehicle is moving. If left open, stored items could become loose during an acci-

dent and strike you. Before you move the vehicle, check to be sure the lower bunk is latched securely. Failure to comply may result in death or personal injury.



WARNING

Be sure the latch that holds the upper bunk in the folded position is working properly so the bunk will not fall down. If the bunk falls, you could be injured.



WARNING

Any loose items on the upper or lower bunk should be moved to a secured place before driving the vehicle. Failure to comply may result in death, personal injury, equipment or property damage.



WARNING

Be sure the restraint system is used when anyone is occupying the sleeper while the vehicle is moving. In an acci-

dent, an unrestrained person lying in a sleeper bunk could be seriously injured. He or she could be thrown from the bunk. Failure to comply may result in death, personal injury, equipment or property damage.



WARNING

Be sure no one ever rides in the upper bunk. That person could be thrown out in an accident and could be very seriously injured. The upper bunk is not equipped with a restraint system. DO NOT use the upper bunk while you are moving. Failure to comply may result in death, personal injury, equipment or property damage.

The sleeper restraint is stored in a compartment on the rear sleeper cab wall. [Sleeper Bunks and Restraints](#) on page 24, for more information on cab/seat restraint systems.



WARNING

Failure to properly use the sleeper restraint when an individual is located in the sleeper bunk and the vehicle is moving can result in death or personal injury.

To Lower Upper Bunk

Pull on the lanyard in the upper left corner of the bunk to release the bunk. This will free it from the anchored position and allow you to lower the bunk.

To Raise Upper Bunk

Fold the upper bunk up and push it against the retaining latch until you hear a click. Pull on the bunk to be sure it is latched securely.

Stopping the Vehicle

A hot engine stores a great amount of heat. It doesn't cool down immediately after you shut it off. Always cool your engine down before shutting it off. You will greatly increase its service life. Idle the engine at 1,000 rpm for five minutes. Then low idle for 30 seconds before shutdown. This will allow circulating coolant and lubricating oil to carry away

heat from the cylinder head, valves, pistons, cylinder liners, turbocharger, and bearings. This way you can prevent serious engine damage that may result from uneven cooling.

Turbocharger

This cooling-down practice is especially important on a turbocharged engine. The turbocharger contains bearings and seals that are subjected to hot exhaust gases. While the engine is operating, heat is carried away by circulating oil. If you stop the engine suddenly, the temperature of the turbocharger could rise as much as 100°F (55°C) above the temperature reached during operation. A sudden rise in temperature like this could cause the bearings to seize or the oil seals to loosen.

Refueling

Air space in your fuel tanks allows water to condense there. To prevent this condensation while you are stopped, fill your tanks to 95 percent of capacity. When refueling, add approximately the same amount to each fuel tank on vehicles with more than one tank.



WARNING

DO NOT carry additional fuel containers in your vehicle. Fuel containers, either full or empty, may leak, explode, and cause or feed a fire. Failure to comply may result in death or personal injury.



WARNING

Diesel fuel in the presence of an ignition source could cause an explosion. A mixture of gasoline or alcohol with diesel fuel increases this risk of explosion. DO NOT remove a fuel tank cap near an open flame. Use only the fuel and/or additives recommended for your engine. Failure to comply may result in death, personal injury, equipment or property damage.

**CAUTION**

Use only Ultra Low Sulfur Diesel (ULSD) Fuel, as recommended by engine manufacturers. If you need further information on fuel specifications, consult the Engine Operation and Maintenance Manual.

If your vehicle is equipped with fuel shut off valves for the take-off and return lines, they are located on the fuel lines entering the top of the fuel tank. Fuel shut off valves for the fuel crossover line are on the bottom of the fuel tank, at the crossover line connection.

Final Stopping Procedures

Your vehicle will be easier to start driving when you are ready, and it will be safer for anyone who might be around it. Please remember, too, that in some states it is illegal to leave the engine running and the vehicle unattended.

**WARNING**

Using the trailer hand brake or air brakes to hold a parked vehicle is dangerous. Because they work with air pressure, these brakes could come loose. Your vehicle could roll, causing an accident involving death or personal injury. Always set the parking brakes. Never rely on the trailer hand brake or truck air brakes to hold a parked vehicle.

**WARNING**

Lift axles that are not equipped with parking brakes should be fully raised when parking the vehicle. Lift axles, that are not equipped with parking brakes, left in the down position while parked, in certain cases, could cause the parked vehicle to roll, causing an accident involving death or personal injury.

1. Set the parking brake before leaving the driver's seat. To hold your vehicle while it is parked, DO NOT rely on:

- Air Brakes
 - Hand Control Valve for Trailer Brakes
 - Engine Compression
2. If you are parked on a steep grade, block the wheels.

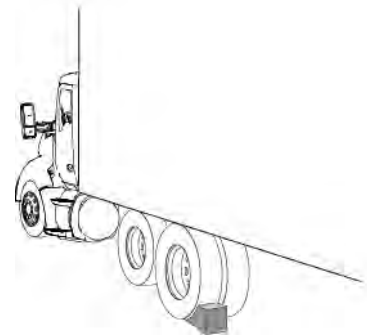

3. Drain water from the air reservoirs. While the engine and air supply system are still warm, drain moisture from the air reservoirs. Open the reservoir drains just enough to drain the moisture. Don't deplete the entire air supply. Be sure to close the drains before leaving the vehicle.

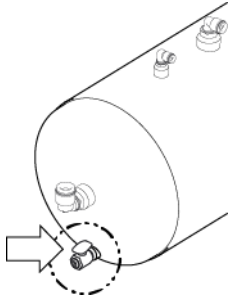

4

4. Secure the vehicle. Close all the windows and lock all the doors.

Chapter 5 | MAINTENANCE

New Vehicle Maintenance Schedule.....	169
First Day.....	169
First 50-100 mi / 80-160 km.....	169
First 500 mi / 800 km.....	170
First 2,000 mi / 3,218 km.....	170
First 3,000-5,000 mi / 4,800-8,000 km.....	170
Maintenance Schedule.....	171
At first 15,000 mi / 24,000 km or at first PM.....	173
Component Specific Intervals.....	178
Every 15,000 mi / 24,000 km / Monthly.....	180
Every 25,000 mi / 40,000 km / 6 Months.....	186
Every 30,000 mi / 48,000 km.....	187
Every 60,000 mi / 96,000 km / 6 Months.....	190
Every 120,000 mi / 192,000 km / Annually.....	200
Every 240,000 mi / 384,000 km.....	205
Every 300,000 mi / 480,000 km / 6,750 Hours / 3 Years.....	206

Every 500,000 mi / 800,000 km / 5 years.....	207
Every 750,000 mi / 1,200,000 km/ 24,000 Hours / 8 years.....	207
Lubricants.....	208
Checking Oil Level.....	209
Air System.....	210
Dual Air System Function Test.....	212
Air Dryer Maintenance.....	212
Air Tanks.....	214
Air Gauges and Air Leaks.....	214
Air Compressor.....	216
Brake System.....	217
Cab Maintenance.....	219
Cab Structure, Doors and Hoods.....	224
Cooling System Maintenance.....	224
Safety Restraint System - Inspection.....	230
Windshield Wiper/Washer.....	233
Electrical System.....	233
Engine Maintenance.....	243
Fuel System.....	248

Frame.....	250
Front Axle and Suspension.....	252
PACCAR 20k Front Axle Lubrication.....	254
Heater and Air Conditioner Maintenance.....	255
Noise and Emission Control.....	257
Diesel Exhaust Fluid (DEF) Tank Straps.....	259
Rear Axle and Suspension.....	259
Steering System.....	265
Driveline.....	267
Tires.....	267
Wheels.....	271
Transmission Maintenance.....	272
Mechanical Clutch	273
Specification Reference Charts.....	274

New Vehicle Maintenance Schedule First Day

First Day
Perform a total vehicle alignment once a body is installed on the truck chassis.
Steering U-joint Pinch Bolt <ul style="list-style-type: none"> • Refer to Steering Shaft Bolt Torque Specifications on page 267 for maintenance instructions.
Front Suspension - U-bolts <ul style="list-style-type: none"> • Check the general condition and the tightness of the nuts. Tighten the U-bolts using a calibrated torque wrench to the specified torque value. (Refer to Suspension U-Bolts, Grade 8 on page 280 for maintenance instructions.)

5

First 50-100 mi / 80-160 km

First 50-100 mi / 80-160 km⁵
Wheel Mounting <ul style="list-style-type: none"> • Refer to Wheels on page 271 for maintenance instructions.

⁵ Ensure that all maintenance intervals leading up to this point are repeated during this interval prior to the completion of those listed here.

First 500 mi / 800 km

First 500 mi / 800 km⁶

Front Axle U-Bolt Torque

- Refer to [Suspension U-Bolts, Grade 8](#) on page 280 for maintenance instructions.

Charge Air Cooler and Air Intake Pipe Clamps

- Retorque fasteners. Refer to [Pipe and Hose Clamp Torque Values](#) on page 274 for maintenance instructions.

5

First 2,000 mi / 3,218 km

First 2,000 mi / 3,218 km⁷

Rear Suspension Fasteners

- Refer to [Rear Axle and Suspension](#) on page 259 for maintenance instructions.

First 3,000-5,000 mi / 4,800-8,000 km

⁶ Ensure that all maintenance intervals leading up to this point are repeated during this interval prior to the completion of those listed here.

⁷ Ensure that all maintenance intervals leading up to this point are repeated during this interval prior to the completion of those listed here.

First 3,000-5,000 mi / 4,800-8,000 km ⁸

Transmission Lubrication

- For Fuller transmission, refer to [Fuller Transmission Lubrication](#) on page 272 for maintenance instructions.

Axle Lubrication.

- For Meritor axle, refer to [Meritor Axle Lubrication](#) on page 263 for maintenance instructions.
- For Eaton/Dana axle, refer to [Eaton/Dana Axle Lubrication](#) on page 262 for maintenance instructions.

Maintenance Schedule

Preventive maintenance program begins with the daily and weekly routine checks [Daily Checks](#) on page 28. Routine vehicle checks can help avoid many large, expensive, and time consuming repairs. The vehicle will operate better, be safer, and last longer. Neglect of recommended maintenance can void your vehicle's warranty. Some maintenance operations demand skills and equipment you may not have. For such situations, please take your vehicle to an authorized Service Center.



WARNING

Before attempting any procedures in the engine compartment, stop the engine and let it cool down. Hot components can burn skin on contact. Failure to comply may result in death, personal injury, equipment or property damage.



WARNING

If the engine must be operating to inspect, be alert and cautious around the engine at all times. Failure to com-

ply may result in death, personal injury, equipment or property damage.



WARNING

If work has to be done with the engine running, always (1) set the parking brake, (2) block the wheels, and (3) ensure that the shift lever or selector is in Neutral. Failure to comply may result in death, personal injury, equipment or property damage.

⁸ **Ensure that all maintenance intervals leading up to this point are repeated during this interval prior to the completion of those listed here.**



WARNING

Exercise extreme caution to prevent neckties, jewelry, long hair or loose clothing from getting caught in the fan blades or another moving engine parts. Failure to comply may result in death, personal injury, equipment or property damage.



WARNING

Always support the vehicle with appropriate safety stands if it is necessary to work underneath the vehicle. A jack is not adequate for this purpose. Failure to comply may result in death, personal injury, equipment or property damage.



WARNING

When working underneath the vehicle without appropriate safety stands but with the wheels on the ground (not supported), make sure that (1) the vehicle is on hard level ground, (2) the

parking brake is applied, (3) all wheels are blocked (front and rear) and (4) remove the ignition key so that the engine cannot be started. Failure to comply may result in death, personal injury, equipment or property damage.



WARNING

NEVER start or let the engine run in an enclosed, unventilated area. Exhaust fumes from the engine contain carbon monoxide, a colorless and odorless gas. Carbon monoxide can be fatal if inhaled. Failure to comply may result in property damage, personal injury, or death.



WARNING

Disconnect the battery ground cable whenever you work on the fuel system or the electrical system. When you work around fuel, do not smoke or work near heaters or other fire hazards. Keep an approved fire extinguisher near to you. Failure to comply

may result in death, personal injury, equipment or property damage.

The following pages contain a table of maintenance tasks with the related intervals for each task on the right side of the table. The top of the table displays a guide to a maintenance interval and its schedule. Some tasks are dependent on the vehicle application. These tasks will be shown as separate tasks and will have the words “ON HIGHWAY”, “CITY DELIVERY” or “OFF-HIGHWAY” after the description. These tasks are differentiated because they are dependent on the vehicle’s operating environment. On highway is defined for applications where the vehicle is NOT used off of a paved road during normal operation. City Delivery is defined for applications where frequent start and stopping is required during normal operation and the highway is used infrequently and for short periods of time. Off highway is defined for applications where the vehicle may be driven off the pavement on a regular basis, even if it is an infrequent basis and/or for a brief time period. Please contact an authorized service dealership if there are questions regarding which interval to follow. Consult the supplier for specific recommendations

where discrepancies develop between these recommendations in this table and component supplier recommendations.

- Engine lubricating oil change intervals aren't listed here. Refer to your engine's operating manual for recommendations. For specific information on maintenance procedures consult your vehicle maintenance manual.
- The initial fill of drive axle lubricant must be changed before the end of

the first scheduled maintenance interval. See the axle manufacturer's operator's manual for recommended lubrication specifications and service intervals.

- The initial fill of lubricant in manual transmissions must be changed before the end of the first maintenance interval. See the transmission manufacturer's operator's manual for

recommended lubrication specifications and service intervals.

- If your vehicle is equipped with an automatic transmission, consult the owner's manual for it that came with your vehicle to obtain lubricant check and change intervals.

At first 15,000 mi / 24,000 km or at first PM

At first 15,000 mi / 24,000 km or at first PM ⁹

Front Suspension U-bolts - U-bolts (ON HIGHWAY)

- Check the general condition and the tightness of the nuts. Tighten the nuts to the specified torque value as required; (Refer to [Suspension U-Bolts, Grade 8](#) on page 280 for maintenance instructions.)

Front Suspension U-bolts - U-bolts (VOCATIONAL)

- Check the general condition and the tightness of the nuts. Tighten the U-bolts after the first day or two of operation. Then tighten the nuts to the specified torque value as required; (Refer to [Suspension U-Bolts, Grade 8](#) on page 280 for maintenance instructions.)

⁹ Ensure that all maintenance intervals leading up to this point are repeated during this interval prior to the completion of those listed here.

At first 15,000 mi / 24,000 km or at first PM ⁹
<p>Drive Axle (SISU) - Axle Housing</p> <ul style="list-style-type: none"> • Change the oil in the differential carrier and the hubs, and clean the magnetic oil drain plugs. (Refer to Drive Axle (SISU) Oil Servicing on page 264 for maintenance instructions.) • Check the wheel bearing hubs and adjust if necessary. (Refer to Drive Axle (SISU) Inspection on page 264 for maintenance instructions.) • Visually inspect for damage or leaks. (Refer to Drive Axle (SISU) Inspection on page 264 for maintenance instructions.)
<p>Rear Suspension - U-bolts</p> <ul style="list-style-type: none"> • Check the torque. Tighten to specified torque value as required. (Refer to Suspension U-Bolts, Grade 8 on page 280 for maintenance instructions.)
<p>Rear Suspension - Frame and Crossmember bolts</p> <ul style="list-style-type: none"> • Check the torque. Tighten to specified torque value as required. (Refer to Frame Fastener Torque Requirements on page 279 for maintenance instructions.)
<p>Rear Suspension - Mounting Brackets and Fasteners</p> <ul style="list-style-type: none"> • Check the condition and the fastener torque. Tighten to the specified torque value as required; (Refer to Rear Axle and Suspension on page 259 for maintenance instructions.)
<p>Main and Auxiliary Transmission - Main and Auxiliary Transmission and Transfer Case</p> <ul style="list-style-type: none"> • Inspect for visible damage, signs of overheating, and leaks. (Refer to Transmission Maintenance on page 272 for maintenance instructions.)
<p>Main and Auxiliary Transmission - Main and Auxiliary Transmission (OFF HIGHWAY)</p> <ul style="list-style-type: none"> • Drain lubricant while warm. Flush each unit with clean flushing oil. (Refer to Transmission Maintenance on page 272 for maintenance instructions.)

⁹ Ensure that all maintenance intervals leading up to this point are repeated during this interval prior to the completion of those listed here.

At first 15,000 mi / 24,000 km or at first PM ⁹
<p>Auxiliary Transmission - Cotta Transfer Case TR2205 Fabco Transfer Case TC142/TC143/TC170/TC270 Marmon-Harrington Transfer Case MVG2000/MVG2000SD</p> <ul style="list-style-type: none"> Initial oil change: Drain oil while warm: flush case with gear oil-compatible fluid, clean magnetic drain plug, and refill. Do not flush the case with any solvent. (Refer to Transmission Maintenance on page 272 for maintenance instructions.)
<p>Cooling - Hoses</p> <ul style="list-style-type: none"> Check the radiator and heater hoses for leaks. (Refer to Cooling System Maintenance on page 224 for maintenance instructions.)
<p>Cooling - Fan Clutch</p> <ul style="list-style-type: none"> Check for air leaks. Check the fan drive bearings (turn the sheave in both directions to check for worn hub bearings.) (Refer to Engine Fan on page 245 for maintenance instructions.)
<p>Cooling - Solenoid Valve</p> <ul style="list-style-type: none"> Check the fan drive for proper engagement and disengagement. (Refer to Engine Fan on page 245 for maintenance instructions.)
<p>Power Steering - Reservoir (ON HIGHWAY)</p> <ul style="list-style-type: none"> Drain, replace the filter, and refill. (For proper disposal of filter and fluid, a power steering fluid filter replacement should be performed at your authorized dealership.)
<p>Power Steering - Reservoir (OFF HIGHWAY)</p> <ul style="list-style-type: none"> Drain, replace the filter, and refill. (For proper disposal of filter and fluid, a power steering fluid filter replacement should be performed at your authorized dealership.)

⁹ Ensure that all maintenance intervals leading up to this point are repeated during this interval prior to the completion of those listed here.

At first 15,000 mi / 24,000 km or at first PM ⁹
<p>Inspect for visible damage, signs of Steering Components - Drag link Tube Clamp and Ball Socket</p> <ul style="list-style-type: none"> • Check the torque: tighten to specified torque value as required. (Refer to Steering System on page 265 for maintenance instructions.)
<p>Steering Components - Pitman Arm Clamp Bolt and Nut</p> <ul style="list-style-type: none"> • Check the torque: tighten to specified torque value as required. (Refer to Steering System on page 265 for maintenance instructions.)
<p>Steering Components - Steering Intermediate Shaft</p> <ul style="list-style-type: none"> • Check the torque on the pinch bolt and nut. (Refer to Steering Shaft Bolt Torque Specifications on page 267 for maintenance instructions.)
<p>Steering Components - Steering Intermediate Shaft U-joints (ON HIGHWAY)</p> <ul style="list-style-type: none"> • Lubricate [EP NLGI #2 HD grease, -10 to 325°F (-23 to 163°C) range]. (Refer to Steering System on page 265 for maintenance instructions.)
<p>Steering Components - Steering Intermediate Shaft U-joints (OFF HIGHWAY or CITY DELIVERY)</p> <ul style="list-style-type: none"> • Lubricate [EP NLGI #2 HD grease, -10 to 325°F (-23 to 163°C) range]. (Refer to Steering System on page 265 for maintenance instructions.)
<p>Steering Components - Drag link and Tie Rod Arm Ball Sockets (ON HIGHWAY)</p> <ul style="list-style-type: none"> • Lubricate (EP NLGI #2 lithium-based, moly-filled, HD grease). (Refer to Steering System on page 265 for maintenance instructions.)

⁹ Ensure that all maintenance intervals leading up to this point are repeated during this interval prior to the completion of those listed here.

At first 15,000 mi / 24,000 km or at first PM ⁹
Steering Components - Drag link and Tie Rod Arm Ball Sockets (OFF HIGHWAY or CITY DELIVERY) <ul style="list-style-type: none"> Lubricate (EP NLGI #2 lithium-based, moly-filled, HD grease). (Refer to Steering System on page 265 for maintenance instructions.)
Fuel and Tanks - Fuel Tank Straps <ul style="list-style-type: none"> Refer to Fuel Tank on page 250 for maintenance instructions.
Driveshafts - Models SPL-90, 1710 and 1810 Slip Member and U-joints <ul style="list-style-type: none"> Lubricate*
Driveshafts - Models SPL- 140/140HD/170/170HD/250/250HD Slip Members and U- joints (OFF HIGHWAY) <ul style="list-style-type: none"> Lubricate*
Electrical and Lights - Fuel and Diesel Exhaust Fluid Tank Sending Unit <ul style="list-style-type: none"> Check the mounting screws and electrical connections for worn or damaged wires and connectors. (Refer to Diesel Exhaust Fluid (DEF) Tank Straps on page 259 for maintenance instructions.)

⁹ Ensure that all maintenance intervals leading up to this point are repeated during this interval prior to the completion of those listed here.

* Use only Spicer Driveshaft approved lubricants when greasing Spicer U-joints.

Component Specific Intervals

These maintenance tasks should be reviewed at each maintenance interval. They are not specific to one interval.

Component Specific Intervals ¹⁰
Drive Axle (Dana) - Axle Housing Drive Axle - Dana on page 262
Drive Axle (Meritor Line Haul / ON HIGHWAY) Drive Axle - Meritor on page 262
Drive Axle (Meritor City Delivery / OFF HIGHWAY) Drive Axle - Meritor on page 262
<p>Front Axle - Vocational (PACCAR) - Kingpin Bushings, Thrust Bearings, and Tie Rod Ball Ends</p> <ul style="list-style-type: none"> Lubricate with approved grease. Weekly regardless of mileage. (Refer to Front Axle and Suspension on page 252 for maintenance instructions.)
<p>Front Axle - Vocational (PACCAR) - Steering Knuckle Spindles, Thrust Bearings, Kingpins, Drawkeys, Tie Rod Ends, Steering Stops, and Bushings</p> <ul style="list-style-type: none"> Inspect for wear and damage and for endplay. Shim or replace as required. Weekly regardless of mileage. (Refer to Front Axle and Suspension on page 252 for maintenance instructions.)
<p>Air Intake - Air filter</p> <ul style="list-style-type: none"> Replace the engine intake air filter element. When required by air restriction indicator or required by the engine manufacturers operator manual. (Refer to Replacing the Engine Air Intake Filter on page 247 for maintenance instructions.)

¹⁰ Ensure that all maintenance intervals leading up to this point are repeated during this interval prior to the completion of those listed here.

Component Specific Intervals ¹⁰
<p>Tires and Wheels - Tires</p> <ul style="list-style-type: none"> • Check inflation pressure. Weekly "cold" using calibrated gauge. (Refer to Tires on page 267 for maintenance instructions.)
<p>Driveshafts - Models SPL-90, 1710 and 1810 slip member and U-joints</p> <ul style="list-style-type: none"> • Inspect. U-joint inspections should be performed every time a vehicle comes in for scheduled maintenance.
<p>Driveshafts - Models SPL-100 slip member and U-joints</p> <ul style="list-style-type: none"> • Inspect. U-joint inspections should be performed every time a vehicle comes in for scheduled maintenance.
<p>Driveshafts - Models SPL-140/140HD/170/170HD/250/250HD slip members and U-joints (ON HIGHWAY and LINEHAUL)</p> <ul style="list-style-type: none"> • Inspect. U-joint inspections should be performed every time a vehicle comes in for scheduled maintenance.
<p>Driveshafts - Models SPL-140/140HD/170/170HD/250/250HD slip members and U-joints (ON HIGHWAY and LINEHAUL)</p> <ul style="list-style-type: none"> • Inspect. U-joint inspections should be performed every time a vehicle comes in for scheduled maintenance.
<p>Driveshafts - Models SPL-140XL/170XL/250XL slip members and U-joints (OFF HIGHWAY)</p> <ul style="list-style-type: none"> • Lubricate. 350,000 mi (560,000 km) 1st interval and then every 100,000 mi (160,00 km) after that.
<p>Driveshafts - Models SPL-140XL/170XL/250XL slip members and U-joints (ON HIGHWAY and LINE HAUL)</p> <ul style="list-style-type: none"> • Inspect. U-joint inspections should be performed every time a vehicle comes in for scheduled maintenance.
<p>Driveshafts - Models SPL-140XL/170XL/ 250XL slip members and U-joints (OFF HIGHWAY and CITY)</p> <ul style="list-style-type: none"> • Inspect. U-joint inspections should be performed every time a vehicle comes in for scheduled maintenance.

¹⁰ **Ensure that all maintenance intervals leading up to this point are repeated during this interval prior to the completion of those listed here.**

* Use only Spicer Driveshaft approved lubricants when greasing Spicer U-joints.

Component Specific Intervals ¹⁰
<p>Aftertreatment System - Diesel particulate filter</p> <ul style="list-style-type: none"> Clean filter. Refer to the <i>Engine Maintenance Manual</i>.
<p>Aftertreatment System - Diesel exhaust fluid supply module</p> <ul style="list-style-type: none"> Replace filter. Refer to the <i>Engine Maintenance Manual</i>.
<p>Air - Air dryer (ON HIGHWAY)</p> <ul style="list-style-type: none"> 360,000 miles/576,000 km (Refer to Air Dryer Maintenance on page 212 for maintenance instructions.)
<p>Air - Air Dryer (Oil- Coalescing Desiccant Cartridge)</p> <ul style="list-style-type: none"> Annually regardless of mileage. (Refer to Air Dryer Maintenance on page 212 for maintenance instructions.)
<p>Engine - Basic Engine Maintenance and service interval recommendations are detailed in the engine manufacturer's Operations and Maintenance Manual included with the vehicle. The engine manufacturer's recommendations vary depending engine model. Information is also available from authorized dealers, the engine manufacturer's authorized service centers, and the engine manufacturer's web site.</p>
<p>Safety - Three-point Safety Belt System</p> <ul style="list-style-type: none"> Inspect. 20,000 miles/32,000km If the vehicle is exposed to severe environmental or working conditions, more frequent inspections may be necessary. (Refer to Safety Restraint System - Inspection on page 230 for maintenance instructions.)

Every 15,000 mi / 24,000 km / Monthly

¹⁰ Ensure that all maintenance intervals leading up to this point are repeated during this interval prior to the completion of those listed here.

Every 15,000 mi / 24,000 km / Monthly ¹¹

Frame - Fifth Wheel

- Check the kingpin lock and plate for wear and function: lubricate (NLGI #2 grease.) (Refer to [Fifth Wheel Monthly Maintenance](#) on page 251 for maintenance instructions.)

Front Suspension - Spring Pins

- Check for proper function. (Refer to [Front Axle and Suspension](#) on page 252 for maintenance instructions.)

Front Suspension U-bolts - U-bolts (OFF HIGHWAY)

- Check the general condition and the tightness of the nuts. Tighten the U- bolts after the first day or two of operation. Then tighten the nuts to the specified torque value as required. (Refer to [Suspension U-Bolts, Grade 8](#) on page 280 for maintenance instructions.)

Drive Axle - Vocational (PACCAR) - Axle Assembly

- Check oil level and inspect for leaks. (Refer to [Rear Axle Lubrication](#) on page 261 for maintenance instructions.)
- Visually inspect for damage or leaks. (Refer to [Rear Axle Lubrication](#) on page 261 for maintenance instructions.)

Drive Axle - Vocational (PACCAR) - Breather

- Check the operation. If the cap doesn't rotate freely, replace. (Refer to [Rear Axle Lubrication](#) on page 261 for maintenance instructions.)

Drive Axle (Meritor City Delivery / OFF HIGHWAY) - Axle Housing

- Check the "cold" fill level at the differential carrier plug for a pinion angle of less than 7 degrees, or at the axle bowl plug for a pinion angle of greater than 7 degrees. Tighten the plug to 35-50 lb-ft (47-68 N·m.) (Refer to [Drive Axle - Meritor](#) on page 262 for maintenance instructions.)
- Visually inspect for damage or leaks. (Refer to [Drive Axle - Meritor](#) on page 262 for maintenance instructions.)

¹¹ **Ensure that all maintenance intervals leading up to this point are repeated during this interval prior to the completion of those listed here.**

Every 15,000 mi / 24,000 km / Monthly ¹¹
<p>Drive Axle (Meritor City Delivery / OFF HIGHWAY) - Breather</p> <ul style="list-style-type: none"> • Check the operation. If the cap doesn't rotate freely, replace. (Refer to Drive Axle - Meritor on page 262 for maintenance instructions.)
<p>Drum Brakes (All) - Slack Adjusters</p> <ul style="list-style-type: none"> • Check the push rod travel and check the control arm for cracks. Adjust at reline. (Refer to Auto Slack Adjuster on page 218 for maintenance instructions.) • Lubricate (NLGI #2 grease.)
<p>Drum Brakes (All) - Brake Air System</p> <ul style="list-style-type: none"> • Check air lines and fittings for leaks. Adjust routing as required to prevent chafing. Check tank mounting and condition. (Refer to How to Check the Compressed Air System for Leaks on page 215 for maintenance instructions.)
<p>Hub, Drum, and Hubcap - Hubcaps</p> <ul style="list-style-type: none"> • Clean the sight window. Check the center plug, mounting flange, and fill plug for leaks and for proper installation. Replace broken or damaged parts. Check the lubricant level and add as required. (Refer to Wheels on page 271 for maintenance instructions.)
<p>Main and Auxiliary Transmission - Main and Auxiliary Transmission and Transfer Case</p> <ul style="list-style-type: none"> • Inspect for visible damage, signs of overheating, and leaks. (Refer to Transmission Maintenance on page 272 for maintenance instructions.)
<p>Auxiliary Transmission - Cotta Transfer Case TR2205 Fabco Transfer Case TC142/TC143/TC170/TC270</p> <ul style="list-style-type: none"> • Inspect: Check oil level, inspect for leaks and any visible damage. (Refer to Transmission Maintenance on page 272 for maintenance instructions.)

¹¹ Ensure that all maintenance intervals leading up to this point are repeated during this interval prior to the completion of those listed here.

Every 15,000 mi / 24,000 km / Monthly ¹¹
<p>Marmon-Harrington Transfer Case MVG2000/MVG2000SD</p> <ul style="list-style-type: none"> • Replace/clean the air filter pre-cleaner, if equipped. (Refer to Transmission Maintenance on page 272 for maintenance instructions.)
<p>Air Intake - Pre-Cleaner</p> <ul style="list-style-type: none"> • Inspect for cuts, irregular wear, missing lugs, sidewall damage, etc. (Refer to Air Intake System on page 246 for maintenance instructions.)
<p>Tires and Wheels - Tires</p> <ul style="list-style-type: none"> • Inspect the wheel disc for any cracks or surface irregularities. Inspect the rim edge and bead seat area for damage. Replace any damaged wheels - DO NOT ATTEMPT TO REPAIR. (Refer to Tires on page 267 for maintenance instructions.)
<p>Tires and Wheels - Disc Wheels</p> <ul style="list-style-type: none"> • Inspect the mounting ring, rim gutter, side ring, and lock ring for damage: replace as required. (Refer to Wheels on page 271 for maintenance instructions.)
<p>Tires and Wheels - Demountable Rims</p> <ul style="list-style-type: none"> • Check the tightness of the fasteners and tighten the fasteners to the specified torque as required. (Refer to Wheels on page 271 for maintenance instructions.)
<p>Tires and Wheels - Wheel Nuts and Studs</p> <ul style="list-style-type: none"> • Inspect for damaged hex corners, stripped or damaged threads, and excessive corrosion: clean or replace as required. (Refer to Wheels on page 271 for maintenance instructions.)
<p>Power Steering - Reservoir</p> <ul style="list-style-type: none"> • Check the fluid level. (Refer to Check Power Steering Fluid Level on page 266 for maintenance instructions.)

¹¹ Ensure that all maintenance intervals leading up to this point are repeated during this interval prior to the completion of those listed here.

Every 15,000 mi / 24,000 km / Monthly ¹¹
<p>Power Steering - Power Assist Cylinder</p> <ul style="list-style-type: none"> Lubricate (EP NLGI #2 lithium-based, moly-filled, HD grease.) (Refer to Steering System on page 265 for maintenance instructions.)
<p>Steering Components - Drag link and Tie Rod Arm Ball Sockets (OFF HIGHWAY or CITY DELIVERY)</p> <ul style="list-style-type: none"> Lubricate [EP NLGI #2 HD grease, -10 to 325°F (-23 to 163°C) range]. (Refer to Steering System on page 265 for maintenance instructions.)
<p>Fuel and Tanks - Fuel Tank Steps</p> <ul style="list-style-type: none"> Check for snug fit of side plates against tank and tank straps. Check for damaged or broken steps, missing bolts, and missing grommet between tank and side plate. Replace missing or damaged parts and adjust for fit as required. (Refer to Fuel Tank on page 250 for maintenance instructions.)
<p>Driveshafts - Models SPL-90, 1710 and 1810 Slip Member and U-joints</p> <ul style="list-style-type: none"> Lubricate *
<p>Driveshafts - Model SPL-100 Slip Member and U-joints</p> <ul style="list-style-type: none"> Check the condition of the cables, cushion clamps, nylon tie straps, and routing. Replace a cushion clamp if the rubber has deteriorated. Repair or tighten terminals, and secure cables to prevent chafing. Replace damaged cables (cuts, cracks, or excessive wear.) (Refer to Batteries on page 237 for maintenance instructions.)
<p>Battery Boxes, Tool Boxes, and Steps - Battery Cables Battery Boxes, Tool Boxes, and Steps - Batteries (OFF-HIGHWAY)</p> <ul style="list-style-type: none"> Check for cracks and damage, electrolyte level, condition of terminals, and tightness of hold downs. (Refer to Batteries on page 237 for maintenance instructions.)

¹¹ Ensure that all maintenance intervals leading up to this point are repeated during this interval prior to the completion of those listed here.

Every 15,000 mi / 24,000 km / Monthly ¹¹
<p>Battery Boxes, Tool Boxes, and Steps - Battery Box and Tray (OFF-HIGHWAY)</p> <ul style="list-style-type: none"> • Check the box integrity. Clean the drain tube and check for acid leaks. Check condition of all equipment mounted under the box. (Refer to Batteries on page 237 for maintenance instructions.)
<p>Battery Boxes, Tool Boxes, and Steps - Battery Cable Fasteners</p> <ul style="list-style-type: none"> • Check battery cable fasteners and tighten as necessary to 10-15 lb-ft (13.6-20.3 N-m) as specified on the battery label. (Refer to Batteries on page 237 for maintenance instructions.)
<p>Electrical and Lights - Warning Lights in Light Bar</p> <ul style="list-style-type: none"> • Check at the ignition start position to verify bulbs and driver information display function. (Refer to Guide to the Warning Symbols on page 73 for maintenance instructions.)
<p>Electrical and Lights - Turn, Stop, Reverse Lights and Signals</p> <ul style="list-style-type: none"> • Visual check. (Refer to Daily Checks on page 28 for maintenance instructions.)
<p>Electrical and Lights - Power Supply Harnesses (engine, Transmission, etc.)</p> <ul style="list-style-type: none"> • Check for worn or damaged insulation, corroded terminals, frayed wires, and oil or fluid leaks on the connectors or wiring. (Refer to Electrical System on page 233 for maintenance instructions.)
<p>Heating and Air Conditioning - Air Conditioner</p> <ul style="list-style-type: none"> • Operate the system. (Refer to Heater and Air Conditioner Maintenance on page 255 for maintenance instructions.)
<p>Heating and Air Conditioning - Cabin Fresh Air Filter (ON HIGHWAY)</p> <ul style="list-style-type: none"> • Inspect and clean, replace if necessary. (Refer to How to Replace Air Conditioner Filter on page 256 for maintenance instructions.)

¹¹ Ensure that all maintenance intervals leading up to this point are repeated during this interval prior to the completion of those listed here.

Every 15,000 mi / 24,000 km / Monthly ¹¹

Heating and Air Conditioning - Cabin Fresh Air Filter (OFF-HIGHWAY)

- Inspect and clean, replace if necessary. (Refer to [How to Replace Air Conditioner Filter](#) on page 256 for maintenance instructions.)

Aftertreatment System - System

- Check for leaks and proper support. (Refer to [Noise and Emission Control](#) on page 257 for maintenance instructions.)

5

Every 25,000 mi / 40,000 km / 6 Months

Every 25,000 mi / 40,000 km / 6 Months¹²

Front Axle - Linehaul (PACCAR) - Kingpin Joint Grease/Tie Rod Ends

- Heavy-Duty Multipurpose Lithium Based: #1 or #2 Grade. (Refer to [Front Axle and Suspension](#) on page 252 for maintenance instructions.)

¹¹ **Ensure that all maintenance intervals leading up to this point are repeated during this interval prior to the completion of those listed here.**

* Use only Spicer Driveshaft approved lubricants when greasing Spicer U-joints.

¹² **Ensure that all maintenance intervals leading up to this point are repeated during this interval prior to the completion of those listed here.**

Every 30,000 mi / 48,000 km

Every 30,000 mi / 48,000 km ¹³
<p>Front Suspension - Spring Pins</p> <ul style="list-style-type: none"> Lubricate with approved grease. (Refer to Front Axle and Suspension on page 252 for maintenance instructions.)
<p>Drive Axle - Linehaul (PACCAR) - Axle Assembly</p> <ul style="list-style-type: none"> Check oil level and inspect for leaks. (Refer to Rear Axle Lubrication on page 261 for maintenance instructions.) Visually inspect for damage or leaks. (Refer to Rear Axle Lubrication on page 261 for maintenance instructions.)
<p>Drive Axle - Linehaul (PACCAR) - Breather</p> <ul style="list-style-type: none"> Check the operation. If the cap doesn't rotate freely, replace. (Refer to Rear Axle Lubrication on page 261 for maintenance instructions.)
<p>Drive Axle - Vocational (PACCAR) - Axle Assembly</p> <ul style="list-style-type: none"> Drain and replace MINERAL BASE lubricant. (Refer to Rear Axle Lubrication on page 261 for maintenance instructions.)
<p>Drive Axle (Meritor Line Haul / ON HIGHWAY) - Axle Housing</p> <ul style="list-style-type: none"> Check the "cold" fill level at the differential carrier plug for a pinion angle of less than 7 degrees, or at the axle bowl plug for a pinion angle of greater than 7 degrees. Tighten the plug to 35-50 lb-ft (47-68 N·m.) (Refer to Drive Axle - Meritor on page 262 for maintenance instructions.) Visually inspect for damage or leaks. (Refer to Drive Axle - Meritor on page 262 for maintenance instructions.)

¹³ Ensure that all maintenance intervals leading up to this point are repeated during this interval prior to the completion of those listed here.

Every 30,000 mi / 48,000 km ¹³
<p>Drive Axle (Meritor Line Haul / ON HIGHWAY) - Breather</p> <ul style="list-style-type: none"> • Check the operation. If the cap doesn't rotate freely, replace. (Refer to Drive Axle - Meritor on page 262 for maintenance instructions.)
<p>Drum Brakes (All) - Brake Treadle Valve</p> <ul style="list-style-type: none"> • Clean the area around the treadle, boot, and mounting plate. Check the pivot and mounting plate for integrity. Check the plunger boot for cracks. Lubricate roller pin, pivot pin, and plunger (NLGI #2 grease). (Refer to Drum Brake Inspection on page 219 for maintenance instructions.)
<p>Drum Brakes (All) - Brake Lining</p> <ul style="list-style-type: none"> • Inspect: replace as required. (Refer to Drum Brake Inspection on page 219 for maintenance instructions.)
<p>Hub, Drum, and Hubcap - Hubs (non-LMS)</p> <ul style="list-style-type: none"> • Check the bearing endplay and adjust as required. (Refer to Wheels on page 271 for maintenance instructions.)
<p>Hub, Drum, and Hubcap - Hub Seals (all)</p> <ul style="list-style-type: none"> • Check for leaks: replace as required. (Refer to Wheels on page 271 for maintenance instructions.)
<p>Hub, Drum, and Hubcap - Brake Drums</p> <ul style="list-style-type: none"> • Inspect for visible cracks, heat checking, galling or scoring of the braking surface, and for severe corrosion on the outside surface. Check for out-of-round or oversize condition [0.080 in. (2 mm) more than the original diameter]. Replace as required. (Refer to Brake System on page 217 for maintenance instructions.)
<p>Main and Auxiliary Transmission - Main and Auxiliary Transmission and Transfer Case</p> <ul style="list-style-type: none"> • Check the drain plugs for tightness. (Refer to Transmission Maintenance on page 272 for maintenance instructions.)

¹³ **Ensure that all maintenance intervals leading up to this point are repeated during this interval prior to the completion of those listed here.**

Every 30,000 mi / 48,000 km ¹³
<p>Main and Auxiliary Transmission - Main and Auxiliary Transmission</p> <ul style="list-style-type: none"> • Check the oil level: refill as required. (Refer to Transmission Maintenance on page 272 for maintenance instructions.)
<p>Clutch - Clutch Release Bearing</p> <ul style="list-style-type: none"> • Lubricate. • Inspect and adjust when necessary (no adjustment required for SOLO type clutches.)
<p>Cooling - Extended Life Coolant (ELC)</p> <ul style="list-style-type: none"> • Check coolant/antifreeze condition. (Refer to Cooling System Maintenance on page 224 for maintenance instructions.)
<p>Steering Components - Steering Intermediate Shaft U-joints (OFF HIGHWAY or CITY DELIVERY)</p> <ul style="list-style-type: none"> • Lubricate [EP NLGI #2 HD grease, -10 to 325°F (-23 to 163°C) range]. (Refer to Steering System on page 265 for maintenance instructions.)
<p>Steering Components - Drag link and Tie Rod Arm Ball Sockets (ON HIGHWAY)</p> <ul style="list-style-type: none"> • Lubricate (EP NLGI #2 lithium-based, moly-filled, HD grease). (Refer to Steering System on page 265 for maintenance instructions.)
<p>Fuel and Tanks - Fuel Tank Straps</p> <ul style="list-style-type: none"> • Refer to Fuel Tank on page 250 for maintenance instructions.
<p>Electrical and Lights - Fuel and Diesel Exhaust Fluid Tank Sending Unit</p> <ul style="list-style-type: none"> • Check the mounting screws and electrical connections for worn or damaged wires and connectors. (Refer to Diesel Exhaust Fluid (DEF) Tank Straps on page 259 for maintenance instructions.)

¹³ Ensure that all maintenance intervals leading up to this point are repeated during this interval prior to the completion of those listed here.

Every 30,000 mi / 48,000 km ¹³

Heating and Air Conditioning - Heater and Air Conditioner

- Perform the checks per [Heater and Air Conditioner Maintenance](#) on page 255.

Air - Air Compressor Governor

- Replace air strainer. (Refer to [Air Compressor](#) on page 216 for maintenance instructions.)

Air - Air Lines

- Check condition and routing to prevent chafing. (Refer to [Air Compressor](#) on page 216 for maintenance instructions.)

Air - Air Dryer

- Perform the checks listed. (Refer to [Air Dryer Maintenance](#) on page 212 for maintenance instructions.)

Every 60,000 mi / 96,000 km / 6 Months

Every 60,000 mi / 96,000 km / 6 Months ¹⁴

Frame - Fifth Wheel

- Inspect fifth wheel operation. (Refer to [Fifth Wheel Monthly Maintenance](#) on page 251 for maintenance instructions.)

¹³ Ensure that all maintenance intervals leading up to this point are repeated during this interval prior to the completion of those listed here.

¹⁴ Ensure that all maintenance intervals leading up to this point are repeated during this interval prior to the completion of those listed here.

Every 60,000 mi / 96,000 km / 6 Months ¹⁴
<p>Frame - Engine Mounting</p> <ul style="list-style-type: none"> Inspect engine mounts every 60,000 miles (96,000 km). (Refer to Engine Mounting on page 248 for maintenance instructions.) Contact an authorized vehicle OEM dealership if engine mounts need servicing.
<p>Front Axle - Vocational (PACCAR) - Steer Axle Wheel Ends: Oil Bath (Adjusted)</p> <ul style="list-style-type: none"> Synthetic SAE 75W-140, SAE 50. (Refer to Front Axle and Suspension on page 252 for maintenance instructions.) Mineral Oil SAE 75W, 75W-90, 75W-140, 80W-90, 85W-140. (Refer to Front Axle and Suspension on page 252 for maintenance instructions.)
<p>Front Axle - Vocational (PACCAR) - Steer Axle Semi-fluid (Adjusted)</p> <ul style="list-style-type: none"> Semi-Fluid Synthetic Grease: Delo SF, Mobil SCH 007. (Refer to Front Axle and Suspension on page 252 for maintenance instructions.)
<p>Front Axle - Vocational (PACCAR) - Steer Axle Grease Pack (Adjusted)</p> <ul style="list-style-type: none"> Heavy-Duty Multipurpose Lithium Base: #2 Grade. (Refer to Front Axle and Suspension on page 252 for maintenance instructions.)
<p>Front Suspension - Front Spring</p> <ul style="list-style-type: none"> Inspect for cracked leaves, worn bushings, and excessive corrosion. (Refer to Front Axle and Suspension on page 252 for maintenance instructions.)
<p>Front Suspension - Spring Pins and Shackles</p> <ul style="list-style-type: none"> Inspect for worn parts and excessive joint clearance. Shim or replace as required. (Refer to Front Axle and Suspension on page 252 for maintenance instructions.)

¹⁴ Ensure that all maintenance intervals leading up to this point are repeated during this interval prior to the completion of those listed here.

Every 60,000 mi / 96,000 km / 6 Months ¹⁴
<p>Front Suspension - Shock Absorbers</p> <ul style="list-style-type: none"> Inspect for leaking, body damage, and damaged or worn bushings. Replace as required. Check the shock mounting stud torque. (Refer to Front Axle and Suspension on page 252 for maintenance instructions.)
<p>Front Suspension U-bolts - U-bolts (ON HIGHWAY)</p> <ul style="list-style-type: none"> Check the general condition and the tightness of the nuts. Tighten the nuts to the specified torque value as required. (Refer to Suspension U-Bolts, Grade 8 on page 280 for maintenance instructions.)
<p>Front Suspension U-bolts - U-bolts (VOCATIONAL)</p> <ul style="list-style-type: none"> Check the general condition and the tightness of the nuts. Tighten the U- bolts after the first day or two of operation. Then tighten the nuts to the specified torque value as required. (Refer to Suspension U-Bolts, Grade 8 on page 280 for maintenance instructions.)
<p>Drive Axle - Linehaul (PACCAR) - Axle Assembly</p> <ul style="list-style-type: none"> Drain and replace MINERAL BASE lubricant. (Refer to Rear Axle Lubrication on page 261 for maintenance instructions.)
<p>Drive Axle (Dana) - Axle Housing</p> <ul style="list-style-type: none"> Visually inspect for damage or leaks. (Refer to Drive Axle - Dana on page 262 for maintenance instructions.) Check oil level. Check "cold." Torque the drain plug. (Refer to Drive Axle - Dana on page 262 for maintenance instructions.)
<p>Drive Axle (Dana) - Air Shift Unit</p> <ul style="list-style-type: none"> Check the lubricant level. (Refer to Drive Axle - Dana on page 262 for maintenance instructions.)
<p>Drive Axle (Dana) - Lube Pump (OFF HIGHWAY)</p> <ul style="list-style-type: none"> Remove the magnetic strainer and inspect for wear particles. Wash in solvent and dry in air. (Refer to Drive Axle - Dana on page 262 for maintenance instructions.)

¹⁴ Ensure that all maintenance intervals leading up to this point are repeated during this interval prior to the completion of those listed here.

Every 60,000 mi / 96,000 km / 6 Months ¹⁴
<p>Drive Axle (Dana) - Lube Filter (OFF HIGHWAY)</p> <ul style="list-style-type: none"> • Change. (Refer to Drive Axle - Dana on page 262 for maintenance instructions.)
<p>Drive Axle (Dana) - Magnetic Drain Plug and Breather (OFF HIGHWAY)</p> <ul style="list-style-type: none"> • Clean or replace. (Refer to Drive Axle - Dana on page 262 for maintenance instructions.)
<p>Drive Axle (SISU) - Axle Housing</p> <ul style="list-style-type: none"> • Check the wheel bearing hubs and adjust if necessary. (Refer to Drive Axle (SISU) Inspection on page 264 for maintenance instructions.) • Visually inspect for damage or leaks. (Refer to Drive Axle (SISU) Inspection on page 264 for maintenance instructions.) • Check the oil level in the differential carrier and hubs. (Refer to Drive Axle (SISU) Oil Servicing on page 264 for maintenance instructions.)
<p>Drive Axle (SISU) - Breather</p> <ul style="list-style-type: none"> • Check the breather for proper operation. (Refer to Drive Axle - SISU Breather and Brakes on page 264 for maintenance instructions.)
<p>Drive Axle (SISU) - S-cam Brakes</p> <ul style="list-style-type: none"> • Overhaul the brakes: degrease all moving parts, check the bushings and seals for wear. (Refer to Drive Axle - SISU Breather and Brakes on page 264 for maintenance instructions.)
<p>Rear Suspension - U-bolts</p> <ul style="list-style-type: none"> • Check the torque. Tighten to specified torque value as required. (Refer to Suspension U-Bolts, Grade 8 on page 280 for maintenance instructions.)

¹⁴ Ensure that all maintenance intervals leading up to this point are repeated during this interval prior to the completion of those listed here.

Every 60,000 mi / 96,000 km / 6 Months ¹⁴
<p>Drum Brakes (All) - Brake Camshaft Bearing</p> <ul style="list-style-type: none"> • Check for excessive camshaft play in the axial and radial directions. Max allowable play is 0.003 in. Lubricate (NLGI #2 grease). (Refer to Drum Brake Inspection on page 219 for maintenance instructions.)
<p>Drum Brakes (All) - Brake Air System</p> <ul style="list-style-type: none"> • Clean or replace the inline filters. (Refer to Air System on page 210 for maintenance instructions.)
<p>Disc Brakes (Bendix®) - Brake Pads</p> <ul style="list-style-type: none"> • Inspect: replace as required. (Refer to How to inspect brake pads on disc brakes on page 218 for maintenance instructions.)
<p>Disc Brakes (Bendix®) - Brake Disc/rotor</p> <ul style="list-style-type: none"> • Inspect for visible cracks, heat checking, galling, or scoring of surface. Check for runout (max allowable is 0.002 in.) (Refer to Air Disc Brakes on page 218 for maintenance instructions.)
<p>Disc Brakes (Bendix®) - Caliper Sliding Function</p> <ul style="list-style-type: none"> • Ensure caliper slides freely with no obstructions or excessive play. (Refer to Air Disc Brakes on page 218 for maintenance instructions.)
<p>Disc Brakes (Bendix®) - Caliper Slide Pins</p> <ul style="list-style-type: none"> • Inspect protective caps of the guide pins for damage or cracking. (Refer to Air Disc Brakes on page 218 for maintenance instructions.)
<p>Disc Brakes (Bendix®) - System Operation</p> <ul style="list-style-type: none"> • Check operation: inspect as per manufacturer's service literature. (Refer to Air Disc Brakes on page 218 for maintenance instructions.)

¹⁴ Ensure that all maintenance intervals leading up to this point are repeated during this interval prior to the completion of those listed here.

Every 60,000 mi / 96,000 km / 6 Months ¹⁴
<p>Hub, Drum, and Hubcap - LMS Hubs (Dana)</p> <ul style="list-style-type: none"> Inspect for leaks. Check the bearing endplay and adjust as required. (Refer to Wheels on page 271 for maintenance instructions.)
<p>Main and Auxiliary Transmission - Mounting Brackets and Fasteners</p> <ul style="list-style-type: none"> Check the condition of the fasteners and their torque. Tighten to the specified torque value as required. (Refer to Frame Fastener Torque Requirements on page 279 for maintenance instructions.)
<p>Main and Auxiliary Transmission - Oil Cooler</p> <ul style="list-style-type: none"> Clean the fins (air-to-oil type) and body. Check the hose condition and for leaks: replace as required. (Refer to Cooling System Maintenance on page 224 for maintenance instructions.)
<p>Main and Auxiliary Transmission - Main and Auxiliary Transmission (OFF HIGHWAY)</p> <ul style="list-style-type: none"> Drain lubricant while warm. Flush each unit with clean flushing oil. (Refer to Transmission Maintenance on page 272 for maintenance instructions.)
<p>Auxiliary Transmission - Cotta Transfer Case TR2205 Fabco Transfer Case TC142/TC143/TC170/TC270 Marmon-Harrington Transfer Case MVG2000/MVG2000SD</p> <ul style="list-style-type: none"> Initial oil change: Drain oil while warm: flush case with gear oil-compatible fluid, clean magnetic drain plug, and refill. Do not flush the case with any solvent. (Refer to Transmission Maintenance on page 272 for maintenance instructions.) Change oil. (Refer to Transmission Maintenance on page 272 for maintenance instructions.)
<p>Air Intake - Air Intake Piping, Mounting, and Charge Air Cooler</p> <ul style="list-style-type: none"> Check the system for broken pipes, leaks, joint integrity, cleanliness, and proper support. (Refer to Air Intake System on page 246 for maintenance instructions.)

¹⁴ Ensure that all maintenance intervals leading up to this point are repeated during this interval prior to the completion of those listed here.

Every 60,000 mi / 96,000 km / 6 Months ¹⁴
<p>Cooling - Hoses</p> <ul style="list-style-type: none"> • Check the radiator and heater hoses for leaks. (Refer to Cooling System Maintenance on page 224 for maintenance instructions.)
<p>Cooling - Fan Clutch</p> <ul style="list-style-type: none"> • Check for air leaks. Check the fan drive bearings (turn the sheave in both directions to check for worn hub bearings). (Refer to Engine Fan on page 245 for maintenance instructions.)
<p>Cooling - Solenoid Valve</p> <ul style="list-style-type: none"> • Check the fan drive for proper engagement and disengagement. (Refer to Engine Fan on page 245 for maintenance instructions.)
<p>Power Steering - Reservoir (OFF HIGHWAY)</p> <ul style="list-style-type: none"> • Drain, replace the filter, and refill. (For proper disposal of filter and fluid, a power steering fluid filter replacement should be performed at your authorized dealership.)
<p>Power Steering - Steering Gear</p> <ul style="list-style-type: none"> • Check the lash of the sector shaft: adjust as required. (Refer to Steering System on page 265 for maintenance instructions.) • Grease the trunion bearing (EP NLGI #2 lithium-based, moly-filled, HD grease). (Refer to Steering System on page 265 for maintenance instructions.) • Grease the input shaft seal (EP NLGI #2 lithium-based, moly-filled, HD grease). (Refer to Steering System on page 265 for maintenance instructions.)
<p>Power Steering - Hoses and Tubes</p> <ul style="list-style-type: none"> • Check for leaks and chafing. (Refer to Steering System on page 265 for maintenance instructions.)

¹⁴ Ensure that all maintenance intervals leading up to this point are repeated during this interval prior to the completion of those listed here.

Every 60,000 mi / 96,000 km / 6 Months ¹⁴
<p>Steering Components - Drag link Tube Clamp and Ball Socket</p> <ul style="list-style-type: none"> • Check the torque: tighten to specified torque value as required. (Refer to Steering System on page 265 for maintenance instructions.)
<p>Steering Components - Pitman Arm Clamp Bolt and Nut</p> <ul style="list-style-type: none"> • Check the torque: tighten to specified torque value as required. (Refer to Steering System on page 265 for maintenance instructions.)
<p>Steering Components - Steering Intermediate Shaft</p> <ul style="list-style-type: none"> • Check the torque on the pinch bolt and nut. (Refer to Steering Shaft Bolt Torque Specifications on page 267 for maintenance instructions.)
<p>Steering Components - Steering Intermediate Shaft U-joints (ON HIGHWAY)</p> <ul style="list-style-type: none"> • Lubricate [EP NLGI #2 HD grease, -10 to 325°F (-23 to 163°C) range]. (Refer to Steering System on page 265 for maintenance instructions.)
<p>Fuel and Tanks - Fuel Tanks</p> <ul style="list-style-type: none"> • Inspect tanks, brackets, hoses, and fittings for correct location, tightness, abrasion damage, and leaks: repair or replace as required. (Refer to Fuel Tank on page 250 for maintenance instructions.)
<p>Driveshafts - Models SPL- 140/140HD/170/170HD/250/250HD Slip Members and U- joints (ON HIGHWAY and LINEHAUL)</p> <ul style="list-style-type: none"> • Lubricate *
<p>Battery Boxes, Tool Boxes, and Steps - Batteries (ON HIGHWAY and LINE HAUL)</p> <ul style="list-style-type: none"> • Check for cracks and damage, electrolyte level, condition of terminals, and tightness of hold downs. Refer to Batteries on page 237 for maintenance instructions.

¹⁴ **Ensure that all maintenance intervals leading up to this point are repeated during this interval prior to the completion of those listed here.**

Every 60,000 mi / 96,000 km / 6 Months ¹⁴
<p>Battery Boxes, Tool Boxes, and Steps - Battery Box and Tray (ON HIGHWAY and LINE HAUL)</p> <ul style="list-style-type: none"> • Check the box integrity. Clean the drain tube and check for acid leaks. Check condition of all equipment mounted under the box. Check the drain tube and check for acid leaks. Check condition of all equipment mounted under the box. (Refer to Batteries on page 237 for maintenance instructions.)
<p>Electrical and Lights - Headlamps</p> <ul style="list-style-type: none"> • Check the aim and adjust as required. (Refer to Aiming Headlights on page 235 for maintenance instructions.)
<p>Electrical and Lights - Alternator</p> <ul style="list-style-type: none"> • Check operation and output. (Refer to Alternator on page 241 for maintenance instructions.) • Check tightness of the pulley nut. (Refer to Install Engine Belt on page 245 for maintenance instructions.) • Check the tension of the drive belt. (Refer to Install Engine Belt on page 245 for maintenance instructions.) • Check tightness of the terminal hex nuts. (Refer to Install Engine Belt on page 245 for maintenance instructions.)
<p>Electrical and Lights - Starter</p> <ul style="list-style-type: none"> • Check torque on hex nuts. (Refer to Electrical System on page 233 for maintenance instructions.)
<p>Electrical and Lights - ECM Connector</p> <ul style="list-style-type: none"> • Check the tightness of the ECM connector. (Refer to Electrical System on page 233 for maintenance instructions.) for maintenance instructions.)
<p>Electrical and Lights - Wheel Sensors</p> <ul style="list-style-type: none"> • Check for damaged sensors and connectors, and worn or frayed wires. (Refer to Electrical System on page 233 for maintenance instructions.)

¹⁴ Ensure that all maintenance intervals leading up to this point are repeated during this interval prior to the completion of those listed here.

Every 60,000 mi / 96,000 km / 6 Months ¹⁴
<p>Electrical and Lights - Power Supply Harnesses (engine, Transmission, etc.)</p> <ul style="list-style-type: none"> • Check for worn or damaged insulation, corroded terminals, frayed. Wash to remove excess grease. (Refer to Electrical System on page 233 for maintenance instructions.)
<p>Cab Structure, Doors and Hoods - Hood</p> <ul style="list-style-type: none"> • Lubricate the lower hood pivot (only if lube fittings are present). (Refer to Cab Structure, Doors and Hoods on page 224 for maintenance instructions.)
<p>Cab Structure, Doors and Hoods - Hinges and Latch</p> <ul style="list-style-type: none"> • Lubricate with silicone spray. (Refer to Cab Structure, Doors and Hoods on page 224 for maintenance instructions.)
<p>Heating and Air Conditioning - Condenser</p> <ul style="list-style-type: none"> • Clear any debris from the front of the condenser. (Refer to Heater and Air Conditioner Maintenance on page 255 for maintenance instructions.)
<p>Aftertreatment System - Diesel Exhaust Fluid Tank</p> <ul style="list-style-type: none"> • Inspect the tank, straps, brackets, hoses and fittings for abrasion damage, leaks, tightness and fully engaged connectors. (Refer to Diesel Exhaust Fluid (DEF) Tank Straps on page 259 for maintenance instructions.)
<p>Air - System</p> <ul style="list-style-type: none"> • Lubricate. (Refer to Air System on page 210 for maintenance instructions.)

¹⁴ Ensure that all maintenance intervals leading up to this point are repeated during this interval prior to the completion of those listed here.

Every 60,000 mi / 96,000 km / 6 Months ¹⁴

Air - Inline Filters

- Replace elements or clean with solvent. (Refer to [Air Cleaners](#) on page 247 for maintenance instructions.)

Every 120,000 mi / 192,000 km / Annually

5

Every 120,000 mi / 192,000 km / Annually ¹⁵

Frame - Frame Fasteners

- Check for tightness: tighten to the specified torque value as required. (Refer to [Frame Fastener Torque Requirements](#) on page 279 for maintenance instructions.)

Frame - Crossmembers and Mounting Brackets

- Inspect for cracks and loose fasteners. Replace or tighten to the specified torque value as required. (Refer to [Frame Fastener Torque Requirements](#) on page 279 for maintenance instructions.)

¹⁴ **Ensure that all maintenance intervals leading up to this point are repeated during this interval prior to the completion of those listed here.**

* Use only Spicer Driveshaft approved lubricants when greasing Spicer U-joints.

¹⁵ **Ensure that all maintenance intervals leading up to this point are repeated during this interval prior to the completion of those listed here.**

Every 120,000 mi / 192,000 km / Annually ¹⁵
<p>Front Axle - Linehaul (PACCAR) - Steer Axle Wheel Ends: Oil Bath (Adjusted)</p> <ul style="list-style-type: none"> • Synthetic SAE 75W-140, SAE 50W. (Refer to Front Axle and Suspension on page 252 for maintenance instructions.)
<p>Front Axle - Linehaul (PACCAR) - Steer Axle Wheel Ends: Oil Bath (Adjusted)</p> <ul style="list-style-type: none"> • Mineral Oil SAE 75W, 75W-90, 75W-140, 80W-90, 85W-140. (Refer to Front Axle and Suspension on page 252 for maintenance instructions.)
<p>Front Axle - Linehaul (PACCAR) - Steer Axle Semi-fluid (Adjusted)</p> <ul style="list-style-type: none"> • Semi-Fluid Synthetic Grease: Delo SF, Mobil SCH 007. (Refer to Front Axle and Suspension on page 252 for maintenance instructions.)
<p>Front Axle - Linehaul (PACCAR) - Steer Axle Grease Pack (Adjusted)</p> <ul style="list-style-type: none"> • Heavy-Duty Multipurpose Lithium Base: #2 Grade. (Refer to Front Axle and Suspension on page 252 for maintenance instructions.)
<p>Front Axle - Vocational (PACCAR) - Steer Axle Wheel Ends: Oil Bath LMS</p> <ul style="list-style-type: none"> • Synthetic SAE 75W-90. (Refer to Front Axle and Suspension on page 252 for maintenance instructions.)
<p>Drive Axle - Linehaul (PACCAR) - Axle Shaft</p> <ul style="list-style-type: none"> • Tighten the rear axle flange nuts to the specified torque value. (Refer to Rear Axle Lubrication on page 261 for maintenance instructions.)
<p>Drive Axle - Vocational (PACCAR) - Axle Shaft</p> <ul style="list-style-type: none"> • Tighten the rear axle flange nuts to the specified torque value. (Refer to Rear Axle Lubrication on page 261 for maintenance instructions.)

¹⁵ Ensure that all maintenance intervals leading up to this point are repeated during this interval prior to the completion of those listed here.

Every 120,000 mi / 192,000 km / Annually ¹⁵
<p>Drive Axle (Dana) - Air Shift Unit</p> <ul style="list-style-type: none"> Remove the housing cover and drain the lubricant. Wash the parts thoroughly and dry in air. (Refer to Drive Axle - Dana on page 262 for maintenance instructions.)
<p>Drive Axle (Dana) - Breather</p> <ul style="list-style-type: none"> Clean or replace. (Refer to Drive Axle - Dana on page 262 for maintenance instructions.)
<p>Drive Axle (Dana) - Lube Pump (ON HIGHWAY)</p> <ul style="list-style-type: none"> Remove the magnetic strainer and inspect for wear particles. Wash in solvent and dry in air. (Refer to Drive Axle - Dana on page 262 for maintenance instructions.)
<p>Drive Axle (Dana) - Lube Filter (ON HIGHWAY)</p> <ul style="list-style-type: none"> Change. (Refer to Drive Axle - Dana on page 262 for maintenance instructions.)
<p>Drive Axle (Dana) - Magnetic Drain Plug and Breather (ON HIGHWAY)</p> <ul style="list-style-type: none"> Clean or replace. (Refer to Drive Axle - Dana on page 262 for maintenance instructions.)
<p>Drive Axle (Meritor Line Haul / ON HIGHWAY) - Lubricant Filter</p> <ul style="list-style-type: none"> Change the filter. (Refer to Drive Axle - Meritor on page 262 for maintenance instructions.)
<p>Drive Axle (Meritor Line Haul / ON HIGHWAY) - Input Shaft and Pinion Shaft</p> <ul style="list-style-type: none"> Check and adjust the endplay. (Refer to Drive Axle - Meritor on page 262 for maintenance instructions.)
<p>Drive Axle (Meritor Line Haul / ON HIGHWAY) - Axle Shaft</p> <ul style="list-style-type: none"> Tighten the rear axle flange nuts to the specified torque value. (Refer to Drive Axle - Meritor on page 262 for maintenance instructions.)

¹⁵ Ensure that all maintenance intervals leading up to this point are repeated during this interval prior to the completion of those listed here.

Every 120,000 mi / 192,000 km / Annually ¹⁵
<p>Drive Axle (Meritor Line Haul / ON HIGHWAY) - Interaxle Differential</p> <ul style="list-style-type: none"> • Check the operation. (Refer to Drive Axle - Meritor on page 262 for maintenance instructions.)
<p>Drive Axle (Meritor City Delivery / OFF HIGHWAY) - Lubricant Filter</p> <ul style="list-style-type: none"> • Change the filter. (Refer to Drive Axle - Meritor on page 262 for maintenance instructions.)
<p>Drive Axle (Meritor City Delivery / OFF HIGHWAY) - Input Shaft and Pinion Shaft</p> <ul style="list-style-type: none"> • Check and adjust the endplay. (Refer to Drive Axle - Meritor on page 262 for maintenance instructions.)
<p>Drive Axle (Meritor City Delivery / OFF HIGHWAY) - Axle Shaft</p> <ul style="list-style-type: none"> • Tighten the rear axle flange nuts to the specified torque value. (Refer to Drive Axle - Meritor on page 262 for maintenance instructions.)
<p>Drive Axle (Meritor City Delivery / OFF HIGHWAY) - Interaxle Differential</p> <ul style="list-style-type: none"> • Check the operation. (Refer to Drive Axle - Meritor on page 262 for maintenance instructions.)
<p>Drive Axle (SISU) - Axle Housing</p> <ul style="list-style-type: none"> • Change the oil in the differential carrier and the hubs, and clean the magnetic oil drain plugs. (Refer to Drive Axle (SISU) Inspection on page 264 for maintenance instructions.)
<p>Drive Axle (SISU) - Lube Filter</p> <ul style="list-style-type: none"> • Clean the suction filter for the optional pressure lubrication system. (Refer to Drive Axle - SISU Breather and Brakes on page 264 for maintenance instructions.)

¹⁵ Ensure that all maintenance intervals leading up to this point are repeated during this interval prior to the completion of those listed here.

Every 120,000 mi / 192,000 km / Annually ¹⁵
<p>Rear Suspension - Frame and Crossmembers Bolts</p> <ul style="list-style-type: none"> • Check the torque. Tighten to specified torque value as required. (Refer to Rear Axle and Suspension on page 259 for maintenance instructions.)
<p>Rear Suspension - Mounting Brackets and Fasteners</p> <ul style="list-style-type: none"> • Check the condition and the fastener torque. Tighten to the specified torque value as required. (Refer to Suspension U-Bolts, Grade 8 on page 280 for maintenance instructions.)
<p>Hub, Drum, and Hubcap - Hubs (non-LMS) with Standard Seals</p> <ul style="list-style-type: none"> • Clean the components and check for excessive wear or damage. Change the oil and seal. (Refer to Wheels on page 271 for maintenance instructions.)
<p>Cooling - Extended Life Coolant (ELC)</p> <ul style="list-style-type: none"> • Perform lab analysis. If lab analysis shows coolant is unsuitable for continued use: Flush, drain, and refill. Add ELC Extender. (Refer to Cooling System Maintenance on page 224 for maintenance instructions.)
<p>Power Steering - Reservoir (ON HIGHWAY)</p> <ul style="list-style-type: none"> • Drain, replace the filter, and refill. (For proper disposal of filter and fluid, a power steering fluid filter replacement should be performed at your authorized dealership.)
<p>Steering Components - Steering Linkage</p> <ul style="list-style-type: none"> • Check all joints for excessive lash: replace as required. (Refer to Steering System on page 265 for maintenance instructions.)
<p>Fuel and Tanks - Fuel Tank Breathers</p> <ul style="list-style-type: none"> • Check for proper function: clean the drain hoses. (Refer to Fuel Tank on page 250 for maintenance instructions.)

¹⁵ Ensure that all maintenance intervals leading up to this point are repeated during this interval prior to the completion of those listed here.

Every 120,000 mi / 192,000 km / Annually ¹⁵
<p>Driveshafts - Models SPL-140XL/170XL/250XL Slip Members and U- joints (OFF HIGHWAY and CITY)</p> <ul style="list-style-type: none"> Lubricate *
<p>Cab Structure, Doors and Hoods - Body and Cab Hold down Bolts</p> <ul style="list-style-type: none"> Check the condition and tightness. (Refer to Cab Structure, Doors and Hoods on page 224 for maintenance instructions.)
<p>Heating and Air Conditioning - Heater and Air Conditioner</p> <ul style="list-style-type: none"> Full operational and diagnostic check. (Refer to Heater and Air Conditioner Maintenance on page 255 for maintenance instructions.)
<p>Air - Air Dryer (OFF HIGHWAY)</p> <ul style="list-style-type: none"> Replace cartridge. (Refer to Air Dryer Maintenance on page 212 for maintenance instructions.)

Every 240,000 mi / 384,000 km

¹⁵ Ensure that all maintenance intervals leading up to this point are repeated during this interval prior to the completion of those listed here.

* Use only Spicer Driveshaft approved lubricants when greasing Spicer U-joints.

Every 240,000 mi / 384,000 km ¹⁶

Drive Axle - Vocational (PACCAR) - Axle Assembly

- Drain and replace SYNTHETIC BASE lubricant. (Refer to [Rear Axle Lubrication](#) on page 261 for maintenance instructions.)

Hub, Drum, and Hubcap - Hubs (non-LMS) with Outrunner Seals

- Clean the components and check for excessive wear or damage. Change the oil and seal. (Refer to [Wheels](#) on page 271 for maintenance instructions.)

5

**Every 300,000 mi / 480,000
km / 6,750 Hours / 3 Years**

Every 300,000 mi / 480,000 km / 6,750 Hours / 3 Years ¹⁷

Cooling - Extended Life Coolant (ELC)

- Replace blank water filter, if applicable. (Refer to [Cooling System Maintenance](#) on page 224 for maintenance instructions.)

¹⁶ Ensure that all maintenance intervals leading up to this point are repeated during this interval prior to the completion of those listed here.

¹⁷ Ensure that all maintenance intervals leading up to this point are repeated during this interval prior to the completion of those listed here.

Every 500,000 mi / 800,000 km / 5 years

Every 500,000 mi / 800,000 km / 5 years ¹⁸
<p>Front Axle - Linehaul (PACCAR) - Steer Axle Wheel Ends: Oil Bath LMS</p> <ul style="list-style-type: none"> Synthetic SAE 75W-90. (Refer to Front Axle and Suspension on page 252 for maintenance instructions.)
<p>Drive Axle - Linehaul (PACCAR) - Axle Assembly</p> <ul style="list-style-type: none"> Drain and replace SYNTHETIC BASE lubricant. (Refer to Rear Axle Lubrication on page 261 for maintenance instructions.)
<p>Hub, Drum, and Hubcap - LMS Hubs (Dana) with Synthetic Lubricant</p> <ul style="list-style-type: none"> Service the bearings, seals and oil. This interval may be different depending on the results of the regular inspection. (Refer to Wheels on page 271 for maintenance instructions.)
<p>Main and Auxiliary Transmission - Main and Auxiliary Transmission (ON HIGHWAY)</p> <ul style="list-style-type: none"> Drain lubricant while warm. Flush each unit with clean flushing oil. (Refer to Transmission Maintenance on page 272 for maintenance instructions.)

Every 750,000 mi / 1,200,000 km/ 24,000 Hours / 8 years

¹⁸ Ensure that all maintenance intervals leading up to this point are repeated during this interval prior to the completion of those listed here.

Every 750,000 mi / 1,200,000 km/ 24,000 Hours / 8 years ¹⁹

Cooling - Extended Life Coolant (ELC)

- Flush, drain, and refill with new coolant. (Refer to [Cooling System Maintenance](#) on page 224 for maintenance instructions.)

Lubricants

Schedule service more frequently if you are operating under severe conditions such as extreme heat or cold, with very heavy loads, off-road, etc. For any special service requirements, consult your service manuals and your lubricant supplier. Please remember: one key to keeping your truck running at top economy and prolonging its life is proper lubrication servicing. Neglecting this essential aspect of vehicle care can cost time and money in the long run.



WARNING

Handle lubricants carefully. Vehicle lubricants (oil and grease) can be poisonous and cause sickness, personal injury, or death. They can also damage the paint on the vehicle.



CAUTION

DO NOT mix different types of lubricants. Mixing lubricants (oil and grease) of different brands or types could damage vehicle components; therefore, drain (or remove) old lubricants from the unit before refilling it.

Engine

Proper engine lubrication depends on the outside temperatures where you will be driving. Use the oil recommended for the conditions you are most likely to be operating in. You will find a complete engine lubrication service guide in the Engine Operation Manual that came with your vehicle. The engine operator manual contains specific maintenance tasks that you or a qualified service technician need to perform to maintain the engine.

¹⁹ Ensure that all maintenance intervals leading up to this point are repeated during this interval prior to the completion of those listed here.

! WARNING

Exhaust fumes from the engine contain carbon monoxide, a colorless and odorless gas. DO NOT breathe the engine exhaust gas. A poorly maintained, damaged, or corroded exhaust system can allow carbon monoxide to enter the cab. Entry of carbon monoxide into the cab is also possible from other vehicles nearby. Failure to properly maintain your vehicle could cause carbon monoxide to enter the cab, resulting in personal injury or death.

! WARNING

Never idle your vehicle for prolonged periods of time if you sense that exhaust fumes are entering the cab. Investigate the cause of the fumes and correct it as soon as possible. If the vehicle must be driven under these conditions, drive only with the windows open. Failure to repair the source of the exhaust fumes may result in death, personal injury, equipment or property damage.

i NOTE

Keep the engine exhaust system and the vehicle's cab ventilation system properly maintained. It is recommended that the vehicle's exhaust system and cab be inspected (1) By a competent technician every 15,000 miles (24,140 km); (2) Whenever a change is noticed in the sound of the exhaust system; or (3) Whenever the exhaust system, underbody, or cab is damaged.

i NOTE

Use only an exact replacement DPF in exhaust systems. Using a noncompliant DPF as a replacement could violate these standards and also void the emission system's warranty.

Driveline Universal Joints

Refer to the Spicer Universal Joints and Driveshafts service manual and lubrication specifications.

Non-PACCAR Transmissions, Axles and Hubs

For all non-PACCAR brands, see the manufacturer's operator's manual for recommended lubrication specifications and maintenance intervals.

Checking Oil Level

For oil reservoir with side filler plugs (transmission, axles, steering gear boxes, transfer cases, etc.) the oil must be level with the filler opening. Use care when checking the oil level with a finger. Just because you can reach the oil level with a finger does not mean the oil level is correct.

Improper Oil Level



Correct Oil Level



Air System

The operation of the vehicle's braking system and many vehicle accessories depends upon the storage and application of a high-pressure air supply.



WARNING

DO NOT attempt to modify, alter, repair or disconnect any component of the air system. Repairs or modifications to the air system, other than what is described in this section, should only be performed by an authorized dealer. Failure to comply may result in personal injury or death.



WARNING

Prior to the removal of any air system component, always block and hold the vehicle by a secure means other than the vehicle's own brakes. Depleting air system pressure may cause the vehicle to roll unexpectedly resulting in an accident causing personal injury or death. Keep hands away from cham-

ber push rods and slack adjusters, they may apply as system pressure drops.



WARNING

After completing any repairs to the air system, always test for air leaks and check the brakes for safe operation before putting the vehicle in service. Failure to comply may result in property damage, personal injury, or death.



WARNING

Never connect or disconnect a hose or line containing air pressure. It may whip as air escapes. Never remove a component or pipe plug unless you are certain all system pressure has been depleted. Failure to comply may result in property damage, personal injury, or death.



WARNING

Never exceed recommended air pressure and always wear safety glasses when working with air pressure. Never look into air jets or direct them at anyone. Failure to comply may result in property damage, personal injury, or death.



WARNING

Never attempt to disassemble a component until you have read and understood recommended procedures. Some components contain powerful springs and injury can result if not properly disassembled. Use only proper tools and observe all precautions pertaining to use of those tools. Failure to comply may result in property damage, personal injury, or death.



WARNING

Completely bypassing a Bendix® AD-IS air dryer will bypass the system's pressure protection valves. This could lead to loss of air pressure or damage to the vehicle's air system, which could cause an accident involving death or personal injury. Always adhere to the manufacturer's procedure if it is necessary in an emergency to temporarily bypass an AD-IS series air dryer. Failure to comply may result in death, personal injury, equipment or property damage.



WARNING

If a different air dryer brand or model is installed on the vehicle other than what was originally installed, it could cause the air system to not perform correctly unless the full air system design is reviewed and modifications made to comply with Federal Motor Vehicle Safety Standards (FMVSS) 121 AirBrake Systems. Failure to abide by this warning and maintain

compliance to FMVSS 121 could cause loss of vehicle control and may lead to death or serious personal injury.



WARNING

If the supply and service air tanks are not drained at the recommended frequency, water could enter the air lines and valves. This could cause corrosion or blockage, which could compromise the brake system safety and potentially cause an accident. Failure to comply may result in property damage, personal injury, or death.

Your vehicle's compressor takes outside air and compresses it, usually to 100-120 psi (689-827 kPa). The compressed air then goes to the reservoirs to be stored until needed. When you operate your air brakes, the stored compressed air flows into the chambers where it is used to apply your truck and trailer brakes. That is why, when you push down on your brake pedal, you don't feel the same amount of pressure on the pedal that you do when you apply the brakes on your car. All you are doing on your truck is opening an air

valve to allow air to flow into the brake chambers. Contamination of the air supply system is the major cause of problems in air-operated components such as brake valves, and suspension height control valves. To keep contaminants to the lowest possible level, follow these maintenance procedures.

Daily Checks

- Drain moisture from the supply and service air tanks.
- Operate air devices to circulate lubricant within the unit.

Periodically

- Clean filter screens ahead of the valves by removing the screens and soaking them in solvent. Blow them dry with pressurized air before reinstalling them.

Twice a Year

- Maintain the air compressor to prevent excessive oil bypass. See your maintenance manual for details.
- Replace worn seals in valves and air motors as needed.

Dual Air System Function Test

Conduct this test at least every 3 months or if there is any indication of a potential problem.

Park the vehicle on level ground and block the wheels. Have an assistant open drain valves and, where required, observe brake action at the wheels. If a malfunction occurs during this test, do not move the vehicle until the problem has been corrected. Engine should be Off with the key switch to the ON or RUN position.

 NOTE

Tractor air system must be connected to trailer.

Air Dryer Maintenance

 NOTE

Because no two vehicles operate under identical conditions, maintenance and maintenance intervals will vary. Experience is a valuable guide in determining the best maintenance interval for any one particular operation.

 NOTE

A small amount of oil in the system may be normal and should not, in itself, be considered a reason to replace the desiccant cartridge. Oil stained desiccant can function adequately.

Every 900 operating hours or 25,000 miles (40,000 km) or every 3 months check for moisture in the air brake system by opening air tanks, drain cocks, or valves and checking for presence of water. A tablespoon of water found in the air tank would point to the need for a desiccant cartridge change. However, the following conditions can also cause water

accumulation and should be considered before replacing the desiccant cartridge.

- Air usage is exceptionally high and not normal for a highway vehicle. This may be due to accessory air demands or some unusual air requirement that does not allow the compressor to load and unload (compressing and non-compressing cycle) in a normal fashion or it may be due to excessive leaks in the air system.
- In areas where more than a 30°F (17°C) range of temperature occurs in one day, small amounts of water can accumulate in the air brake system due to condensation. Under these conditions, the presence of small amounts of moisture is normal and should not be considered as an indication that the dryer is not performing properly.
- An outside air source has been used to charge the air system. This air did not pass through the drying bed.

Maintenance

 **CAUTION**

Replace oil-coalescing desiccant air dryer cartridge every 1 year regardless of mileage. Only use oil-coalescing desiccant replacement cartridge when replacing. Failure to perform this maintenance task will void the PACCAR Transmission warranty and may result in expensive transmission damage.

Replace (non-oil-coalescing) desiccant cartridge:

- On-highway operation replace every 2-3 years, 350,000 miles (560,000 km) or 10,800 hours.
- High duty cycle usage such as transit bus, refuse hauler, dump truck, cement mixers and off-highway operation replace every 1 year, 100,000 miles (160,000 km) or 3,600 hours.

 **NOTE**

Review the warranty policy before performing any maintenance procedures. An extended warranty may be voided if unauthorized maintenance is performed during this period.

Bendix® AD-HF Series Air Dryer

Your vehicle may be equipped with a Bendix® AD-HF series air dryer. Any air dryer replacement should be made with an identical component.

 **WARNING**

Use of an air dryer brand or model that differs from what was originally installed could cause the air system to not perform correctly unless the full air system design is reviewed and modifications are made to comply with Federal Motor Vehicle Safety Standard (FMVSS) 121 Air Brake Systems. Failure to abide by this warning and maintain compliance with FMVSS 121

could cause loss of vehicle control and may lead to serious personal injury or death.

The AD-HF Series air dryer has incorporated into its design various components that have typically been installed separately on the vehicle (see below for components/areas affected):

- Pressure protection valves
- Safety valve
- Solenoid valves and plumbing
- Plumbing of the front and rear service air tanks
- Plumbing to accessory systems

These components are required to meet the Federal Motor Vehicle Safety Standards (FMVSS 121 - Air Brake Systems). As the Warning above states, any other type of air dryer installed in the place of an AD-HF Series will require changes, modifications and/or additions to your vehicle's air system to maintain compliance with FMVSS 121.

Air Tanks

WARNING

If the supply and service air tanks are not drained at the recommended frequency, water could enter the air lines and valves. This could cause corrosion or blockage, which could compromise the brake system safety and potentially cause an accident. Failure to comply may result in property damage, personal injury, or death.

CAUTION

DO NOT use penetrating oil, alcohol, brake fluid, or wax-based oils in the air system. These fluids may cause severe damage to air system components.

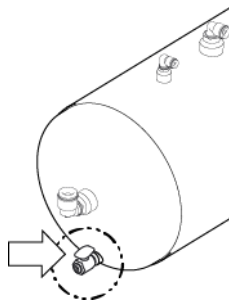

To eject moisture from the air system tanks, pull the line that is connected to the moisture ejection valve. Continue pulling until the air comes out free of water.

Daily

The supply and service air tanks, must be drained on a daily basis. Operate air devices daily to circulate lubricants within the unit.

Periodically

Clean filter screens ahead of the valves by removing the screens and soaking them in solvent. Blow them dry with pressurized air before reinstalling them.

- Maintain the air compressor to prevent excessive oil bypass

- Replace worn seals in valves and air motors as they are needed. Your authorized dealer carries rebuild kits for most units

Air Gauges and Air Leaks

WARNING

DO NOT operate the vehicle if leakage in the air system is detected. Conduct the following procedure and contact an authorized dealer (or any other properly equipped service center) if a leak is detected. Failure to check the brakes or follow these procedures could cause a system failure, increasing the risk of an accident and may result in personal injury, property damage, or death.

If your vehicle is equipped with air brakes, it has two separate, additional air systems: Primary and Secondary. Each air system is monitored by a gauge indicating system pressure in either pounds per square inch (psi), and/or kilopascals (kPa).

The Primary gauge indicates pressure in the rear braking system:

Primary Air Pressure Gauge



The Secondary gauge indicates pressure in the front braking system:

Secondary Air Pressure Gauge



The Primary and Secondary Air Pressure gauges are shown in the Primary Gauges View on the Digital Display.²⁰

At start-up, the Primary and Secondary Air Pressure gauges may indicate red, and the Low Air System Pressure alarm may sound until the minimum operational pressure setpoint of 65 psi (448 kPa) is reached.^{21,22} If the tanks are empty, this can take up to two minutes. If these gauges remain red, turn red, indicate below 65 psi (448 kPa) or the alarm starts or does not turn off, do not

attempt to drive the vehicle until the problem is found and fixed: system pressure is too low for normal brake operation.

	NOTE
Park brakes lock up at 60 psi (414 kPa), the audible alarm will sound at 65 psi (448 kPa).	

How to Check the Compressed Air System for Leaks

	WARNING
DO NOT operate the vehicle if leakage in the air system is detected. Conduct the following procedure and contact an authorized dealer (or any other properly equipped service center) if a leak is detected. Failure to check the brakes or follow these procedures could	

cause a system failure, increasing the risk of an accident and may result in personal injury, property damage, or death.

Use this procedure to check the compressed air system due to the following:

- After maintenance
- When an air system component is replaced
- When a leak is suspected
- Periodically, to ensure system integrity

To check for Air System leaks

1. Start the engine if not already running.
2. **Scroll** to either the Basic or Enhanced View to monitor Primary and Secondary Air Pressures: see (1) of Enhanced View.

²⁰ The model 520 Right-hand Stand-up uses additional physical gauges for Primary and Secondary Air Pressure.
²¹ The model 520 Right-hand Stand-up also indicates low air pressure using a warning light in the physical gauges.
²² The Low Air System Pressure alarm is not active when the engine is off.

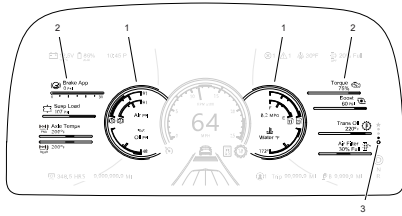

3. Build up air pressure in the system until the system cutout setpoint or until 120 psi (827 kPa) is reached.
4. Turn the Ignition Switch to OFF (stopping the engine) and then back to the ON position, but don't start the engine. The Basic or Enhanced View will appear.
5. Release the service brakes, and observe the rate of air pressure drop. This rate should not exceed 2.0 psi (14 kPa) per minute.
6. Start the engine and build up air pressure again.
7. Turn the Ignition Switch to OFF (stopping the engine) and then back to the ON position, but don't start the engine.
8. Apply the brakes fully, holding the pedal down for five minutes. The

pressure drop should not exceed 3.0 psi (21 kPa) per minute.

9. If you detect excessive leakage (air pressure loss greater than 3.0 psi (21 kPa) after five minutes of brake application), a leakage test should be made at the air line connections and at all air brake control units. These tests should determine where air is escaping.

Air Compressor

All compressors, regardless of make or model, run continuously while the engine is running. System pressure is controlled by the governor. The governor acts in conjunction with the unloading mechanism in the compressor cylinder block to start and stop compression of air. The compressor is unloaded when the system pressure reaches 120 psi (827 kPa) and compression is reestablished when system pressure falls to 100 psi (690 kPa).

Preventive Maintenance

The following service checks are provided for your information only and should be performed by a certified mechanic. Contact

your dealer or the engine manufacturer's Maintenance Manual for further information on servicing air compressors. After completing any repairs to the air system, always test for air leaks, and check the brakes for safe operation before putting the vehicle in service. Below is a list of areas to maintain for the air compressor:

- Inspect compressor air filter element, if so equipped, and replace element if clogged. Check compressor mounting and drive for alignment and belt tension. Adjust if necessary.
- Remove compressor discharge valve cap nuts and check for presence of excessive carbon. If excessive carbon is found, clean or replace the compressor cylinder head. Also, check compressor discharge line for carbon, and clean or replace the discharge line if necessary.
- Disassemble compressor and thoroughly clean and inspect all parts. Repair or replace all worn or damaged parts, or replace compressor with a factory exchange unit.

Brake System

To learn more about brakes, see the Index, under Brakes.



WARNING

DO NOT work on the brake system without the parking brake set and wheels chocked securely. If the vehicle is not secured to prevent uncontrolled vehicle movement, it could roll and cause damage to the vehicle, serious personal injury, or death.



CAUTION

The air brake system of this vehicle was configured for ONE of the following operations: tractor or truck, and complies with the respective portions of FMVSS 121. A tractor shall not be operated or configured as a truck, nor shall a truck be operated or configured as a tractor, without significant modifications to the air brake system in order

to retain compliance with FMVSS 121. Contact your dealer for instructions.



WARNING

DO NOT use brake linings with a thickness below the specified minimum. Such linings will have lining rivets exposed that can damage the brake drum and reduce brake efficiency, which could cause death, personal injury or system failure.



WARNING

DO NOT use any replacement part in the brake system unless it conforms exactly to original specifications. A nonconforming part in your vehicle's brake system could cause a malfunction resulting in an accident causing death or personal injury. Sizes and types are so related to one another that a seemingly unimportant change in one may result in a change in how well the brakes work for you on the road. If parts do not work together properly, you could lose control of your

vehicle, which could cause a serious accident.

Brake adjustment and brake balance must be set carefully to (1) make the most efficient use of the forces available for braking and (2) allow equal stopping forces at all wheels. Once a brake system is set to specifications, changing any one of its components or any combination of components may cause the system to not work as well. All parts have to work together to perform as they should. Any replacement components in your brake system should be exactly equal to the original components. Any changes from the original specifications can affect the whole system. All of the following areas are interrelated and must conform to original specifications:

- Tire size
- Drum brakes
- Cam radius
- Wedge angle
- Drum radius
- Brake linings
- Brake chambers
- Slack adjusters
- Disc brakes

- Disc rotors

All vehicle operators should check their brakes regularly.

Air Disc Brakes

This vehicle may have disc brakes instead of drum brakes.

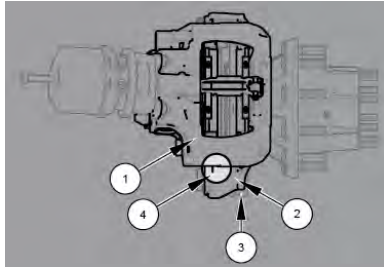

1. Brake caliper
2. Caliper mounting flange
3. Brake rotor
4. Inspection notches

How to inspect brake pads on disc brakes

To inspect the brake pads:

1. Park on level ground and chock the wheels.
2. Temporarily release the parking brakes.

3. Looking from the ground up at the bottom of the caliper and rotor, compare the relative position of two notches; one located on the caliper and the other on the carrier.
4. Take a measurement from between these two notches and compare them to the specifications to determine if the pads need to be replaced.

Have a qualified mechanic perform a detailed inspection if the notches are not found. The pads and rotors should be measured and compared against the manufacturers specifications located in the brake manufacturer's service manual.

Inspect Disc Brake Caliper for Running Clearance

Regularly inspect caliper for Running Clearance:

1. Stop the vehicle on level ground and let the brakes cool down. Hot brake calipers can burn skin on contact.
2. Chock the wheels.
3. Temporarily release the parking brakes.
4. Grab the caliper and move it. This movement is Running Clearance.

5. Proper Running Clearance is 0.08 in. (2 mm) of movement of the brake caliper (approximately the thickness of a nickel) in the inboard/outboard direction.

Have a qualified mechanic provide further inspection if the caliper does not move or appears to move more than the specified clearance

Auto Slack Adjuster

The auto slack adjuster is a mechanism to maintain the correct amount of space between the braking surface and the friction material.

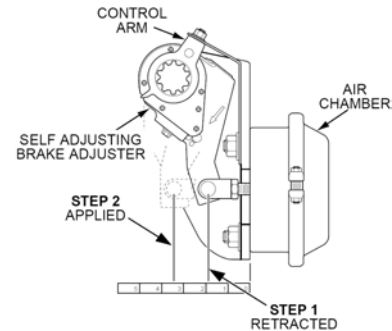

1. Retracted position, no brake pedal applied

2. Applied position, brake pedal engaged

Drum Brake Inspection

Have brake drum linings inspected by a qualified mechanic for wear at regular intervals according to the maintenance schedule. In severe service or off-highway applications inspect the linings more frequently. In addition, periodically check the brake chamber stroke. Replace the slack adjuster if proper stroke cannot be maintained.

Operational checks of automatic slack adjusters

1. Start the vehicle and get the air system up to normal operating pressure. Do not apply the parking brake.
2. Apply pressure to the brake pedal and measure the distance the air chamber pushrod traveled.
3. Compare the results to the specification to determine if the automatic slack adjusters need replacing.

 **WARNING**

Manual adjustment of automatic slack adjusters is a dangerous practice that could have serious consequences. It gives the operator a false sense of security about the effectiveness of the brakes. Contact the Service Department at your dealership if the stroke exceeds specifications. A stroke exceeding specifications may indicate a problem with the slack adjuster or the brake foundation.

Automatic Slack Adjuster Stroke Specification

Chamber Type	Stroke
36 (rear brakes)	1.5-2.5 in. (38-57 mm)
30 (rear brakes)	1.5-2 in. (38-51 mm)
16, 20 and 24 (front brakes)	1-1.75 in. (25.4-44.4 mm)

Cab Maintenance

Cab exterior, interior, frame and engine compartment components need maintenance to ensure longevity and safe operations. A clean vehicle also allows leaks to be detected easier.

 **WARNING**

Always allow hot surfaces to cool down before attempting to work near them. Failure to comply may result in personal injury or death.

 **WARNING**

Handle cleaning agents carefully. Cleaning agents may be poisonous. Keep them out of the reach of children. Failure to comply may result in property damage, personal injury, or death.



WARNING

DO NOT use gasoline, kerosene, naphtha, nail polish remover or other volatile cleaning fluids. They may be toxic, flammable or hazardous in other ways. Failure to comply may result in personal injury, property damage or death.



WARNING

DO NOT clean the underside of chassis, fenders, wheel covers, etc. without protecting your hands and arms. You may cut yourself on sharp edged metal parts. Failure to comply may result in personal injury, property damage, or death.



WARNING

Moisture, ice, and road salt on brakes may affect braking efficiency. Test the brakes carefully after each vehicle wash. Failure to comply may result in

death, personal injury, equipment or property damage.

Vehicle Cleaning

- Observe all caution labels
- Always read directions on the container before using any product
- Do not use any solution that can damage the body paint
- Most chemical cleaners are concentrates that require dilution
- Only use spot removing fluids in well ventilated areas
- Any vehicle is subjected to deterioration from multiple causes (i.e. industrial fumes, ice, snow, corrosive road salt, etc..)

Exterior and Engine Compartment

Corrosive materials used to remove ice, snow and dust from the road can collect on the entire vehicle with concentrated accumulations throughout the underbody and engine compartment. If these materials are not removed, accelerated corrosion (rust) can occur on underbody parts such as fuel lines, frame rails, floor pan, electrical and exhaust system, even

though they have been provided with corrosion protection. At least every spring, flush these materials from the entire vehicle, including the underbody and engine compartment, with plain water using light water pressure. On vehicles used in applications and/or areas that experience high usage of, or exposure to, corrosive materials, cleaning of the entire vehicle should be done more frequently. If desired, your dealer can do this service for you.



CAUTION

Do not direct high pressure water onto seals or flexible hoses. Water may enter the part which will contaminate the system lubricants and fluids. To prevent damage to these components, keep a gentle flow of water moving at all times. Failure to comply may result in equipment damage.



CAUTION

Do not direct high pressure water onto electrical components, plug connectors, seals or flexible hoses on the engine. Failure to comply can accelerate corrosion and degrade electrical component which may cause a fire or equipment damage.

To prevent rust, keep chromed parts clean and protected with wax at all times, especially in winter conditions when the roads are salted.

- If necessary, use a commercial chrome cleaner to remove light rust.
- Chrome surfaces are best cleaned with fresh water. Wipe dry to preserve their luster. A commercial chrome cleaner will remove light rust. After cleaning, wax flat surfaces and apply a thin coat of rust preventive lubricant around bolts or other fasteners.
- Clean aluminum wheels and bumpers with cool water. Tar-remover will get rid of heavy deposits of road grime. To prevent

spotting, wipe aluminum surfaces dry after washing.

- Under corrosive conditions, such as driving on salted roads, clean aluminum parts with steam or high-pressure water from a hose. A mild automotive soap solution will help. Rinse thoroughly.

To maintain the tailpipe's quality finish, wash the tailpipe with a soft cloth, mild automotive soap, and water or glass cleaner. A non-abrasive chrome polish can be used sparingly on hard-to-clean areas. DO NOT clean your high-heat chrome using scouring pads, abrasive chrome polish, highly acidic chemical cleaners or any other abrasive cleaners. Even high quality stainless steel parts can rust under prolonged exposure to salt water, especially when the salt-laden moisture is held against the metal surface by road grime. It is important to frequently clean salty moisture and grime from stainless steel surfaces.

- If surface rust is encountered, wash the surface and use a commercial polishing compound to clean off the rust, followed by a coating of wax.
- Never use steel wool when cleaning stainless steel. Minute

particles of the steel wool can become embedded in the surface of the stainless steel part and cause rust staining.

Weather Stripping

Frequent washing of the vehicle is required to remove road grime and contaminants that can stain and oxidize paint and accelerate corrosion of plated and polished metal surfaces. Waxing offers added protection against staining and oxidation. Do not apply wax in the hot sun and do not friction burn the paint with a buffing machine. Occasionally spray weather-stripping on doors and windows with silicone compound to help preserve resiliency. This is especially useful in freezing weather to prevent doors and windows from sticking shut with ice.



NOTE

To allow enough time for your truck's finish to cure, wait at least thirty days after the date of manufacture before waxing.

Cleaning Interior Vinyl and Upholstery



NOTE

Strong cleaning agents such as hand sanitizer, solvents, paint thinners, window cleaner and gasoline/ diesel fuel must never be used on your vehicle's interior. Repeated exposure to chemicals such as sunscreen, insect repellents containing DEET, or brake fluid may cause accelerated wear, tackiness or discoloration of interior surfaces.

Wipe vinyl upholstery and lining with a good commercial upholstery cleaner. Do not use acetone or lacquer thinner. Clean fabric upholstery with upholstery shampoo specially formulated for this purpose.

- First remove loose dirt, dust or debris with a vacuum cleaner.
- Use a soft brush to loosen caked-on dirt before vacuuming it away.
- Wipe the fabric surface with a slightly damp cloth and dry the seat fabric thoroughly. If the fabric is still dirty, wipe using a mixture of mild

soap and lukewarm water, then dry thoroughly.

- If the stain does not come out use an upholstery shampoo specially formulated for this purpose. Test the cleaner on a hidden place to make sure it does not harm the fabric. Follow the instructions on the container.

Other interior surfaces may be cleaned using a mixture of mild soap and lukewarm water, or an automotive interior cleaner, used on its intended surface (i.e. use leather conditioner on leather surfaces, etc.).

Avoid frequent or repeated use of the following products on interior surfaces:

- Alcohol-based cleaners (including hand sanitizer)
- Methanol-based cleaners
- Bleach
- Acetone
- Any other strong solvent
- Abrasive cleaners
- Sunscreen

How to Wash the Exterior of the Vehicle

Your dealer has a number of vehicle-care products and can advise you on which ones to use for cleaning the exterior and interior of your vehicle.



WARNING

Handle cleaning agents carefully. Cleaning agents may be poisonous. Keep them out of the reach of children. Failure to comply may result in property damage, personal injury, or death.



WARNING

DO NOT use gasoline, kerosene, naphtha, nail polish remover or other volatile cleaning fluids. They may be toxic, flammable or hazardous in other ways. Failure to comply may result in personal injury, property damage or death.



WARNING

DO NOT clean the underside of chassis, fenders, wheel covers, etc. without protecting your hands and arms. You may cut yourself on sharp edged metal parts. Failure to comply may result in personal injury, property damage, or death.



WARNING

Moisture, ice, and road salt on brakes may affect braking efficiency. Test the brakes carefully after each vehicle wash. Failure to comply may result in death, personal injury, equipment or property damage.



CAUTION

DO NOT aim the water jet directly at door locks or latch. Tape the key holes to prevent water from seeping into the lock cylinders. Water in lock cylinders should be removed with compressed air. To prevent locks from freezing in

the winter, squirt glycerin or lock deicer into the lock cylinders.



NOTE

To allow enough time for your truck's finish to cure, wait at least thirty days after the date of manufacture before waxing.

1. Begin by spraying water over the dry surface to remove all loose dirt before applying the car wash solution.



CAUTION

Do not direct high pressure water onto seals or flexible hoses. Water may enter the part which will contaminate the system lubricants and fluids. To prevent damage to these components, keep a gentle flow of water moving at all times. Failure to comply may result in equipment damage.



CAUTION

Do not direct high pressure water onto electrical components, plug connectors, seals or flexible hoses on the engine. Failure to comply can accelerate corrosion and degrade electrical component which may cause a fire or equipment damage.

- Do not wash the vehicle in direct sunshine.
 - Do not spray water directly into the cab vents.
2. Using soapy water, wash the vehicle with a clean soft cloth or a soft brush made for automotive cleaning.
 - Use cool water and a mild, automotive-type soap. Strong industrial detergents, cleaning agents and household-type soaps are not recommended and may damage the vehicle's paint.
 - Do not use stiff brushes, paper towels, steel wool, or abrasive cleaning compounds because

- they will scratch painted, plated, and polished metal surfaces.
3. Rinse painted surfaces with gentle water pressure frequently while washing to flush away dirt that might scratch the finishes during the washing operation.
 4. Hose dirt and grime from the entire chassis.



CAUTION

Do not direct high pressure water onto seals or flexible hoses. Water may enter the part which will contaminate the system lubricants and fluids. To prevent damage to these components, keep a gentle flow of water moving at all times. Failure to comply may result in equipment damage.



CAUTION

Do not direct high pressure water onto electrical components, plug connectors, seals or flexible hoses on the engine. Failure to comply can accelerate corrosion and degrade electrical com-

ponent which may cause a fire or equipment damage.

5. Wipe everything dry with a chamois to avoid water spots. To prevent water spotting, dry off the cosmetic surfaces with a clean cloth or chamois.
6. Remove road tar with an automotive-type tar remover or mineral spirits.
7. After cleaning and drying the entire vehicle, apply a quality automotive wax to protect the vehicle's finish.

Care of Display Screens on the Dashboard

To clean the screen, dampen a clean, soft, lint-free cloth with water only. A mild glass cleaner that does not contain alcohol or ammonia may also be used. Cleaners that contain alcohol and/or ammonia will eventually dry-out, crack and "yellow" the screen. Wipe the screen gently back and forth. You can also use a commercial cleaner especially designed for LCD screens.

Cab Structure, Doors and Hoods

Lubricate the lower hood pivot (only if lube fittings are present.)

Cooling System Maintenance

The cooling system in your vehicle was factory filled with extended life coolant that meets or exceeds all ASTM D6210 and Caterpillar EC-1 requirements. PACCAR recommends only using a 50/50 mixture of distilled water and ELC when cooling system service is required. A 50/50 mixture of ELC and distilled water will provide freeze protection down to -34°F (-36.7°C), which is adequate for most locations in North America. For extremely cold operating conditions, a 60/40 mixture (coolant/water ratio) can be used to provide freeze protection down to -62°F (-52.2°C).

Unless otherwise optioned, factory fill coolant is an ethylene glycol, nitrated organic acid technology (NOAT) extended

life coolant (ELC) formulation at a 50:50 coolant-to-distilled water mixture. The factory fill exceeds ASTM D6210 and Caterpillar EC-1 requirements. Maintaining coolant chemistry and freeze protection is critical to engine and cooling system component health and longevity.



WARNING

Coolant is toxic. DO NOT get the fluid in eyes. If contact occurs, flood eyes with large amounts of water for 15 minutes. Avoid prolonged or repeated contact with skin. In case of contact, immediately wash skin with soap and water. DO NOT take internally. If swallowed, seek immediate medical attention. DO NOT induce vomiting. Failure to comply may result in death, personal injury, equipment or property damage.



CAUTION

The engine cooling system has very specific maintenance and inspection requirements. Failure to follow requirements can damage the engine. Engine

damage can include but is not limited to freezing, boiling, corrosion, pitted cylinder liners. This information is found in the engine manufacturers owner's manual. It is the owner's responsibility to follow all requirements listed in the engine manufacturers owner's manual.



NOTE

Coolant is harmful to the environment. Unused coolant must be stored as a toxic hazardous material in leakproof containers. Used coolant must be processed as industrial chemical waste. Please follow HAZMAT guidelines with both used and unused coolants.



CAUTION

Use of non-genuine PACCAR coolant filters may cause severe engine damage.

Concentration

Check the level of freeze/boil over protection, which is determined by the glycol concentration. Use a glycol refractometer to determine glycol level. Add coolant to obtain the coolant/water ratio required to provide the protection you need. A 50/50 mix of coolant and water is adequate for most applications. For extremely cold operating conditions, the ratio can be adjusted to a higher concentration of coolant.



NOTE

Maximum recommended ELC concentration is 60% ELC and 40% water by volume (a 60/40 coolant mixture). The minimum recommended concentration is 40%.

Glycol Concentration Level

Level	Desired Coolant / Water Ratio	Freeze Point °F (°C)
Recommended Levels	40%	-12 (-24)
	45%	-23 (-31)
	50%	-34 (-37)
	55%	-50 (-46)
	60%	-62 (-52)

Condition

Perform a visual inspection of the coolant. It should have no cloudiness or floating debris. Determine the chemical inhibitor concentration level by using an extended life coolant specific test kit or test strips. Inhibitor concentration level determines corrosion protection. If you are concerned about possible coolant quality, contamination, or mechanical problems, submit a coolant sample for analysis. Improper maintenance may cause coolant

degradation and could result in damage to the cooling system and engine components. Consult your dealer or the coolant manufacturer's representative for recommended extended life coolant test kits, test strips, and laboratory sample procedures.

Coolant Extender

Add extended life coolant extender, if necessary, according to the corrosion inhibitor concentration required. DO NOT add coolant extender to nitrite-free coolant.

Checking Coolant Level

Check the coolant level daily. See [Coolant Level](#) on page 227.



CAUTION

When adding coolant, avoid mixing different brands and formulations. If the coolant is mixed with more than 25% of a different formulation (for example, mixing OAT and NOAT coolants), engine corrosion damage could occur. If mixing exceeds 25% of total system volume, it is recommended to flush

and refill the system completely with one type of coolant.

Coolant Filter

Your engine is equipped with a coolant filter designed to capture and remove harmful deposits from the cooling system to help prolong system life. It is a "blank filter" and does not contain chemicals or time-release additives. Replace it only with a blank filter at the interval specified in the Preventative Maintenance Schedule. NEVER use filters that contain supplemental coolant additives (SCAs) in an ELC-filled system.



CAUTION

Use of non-genuine PACCAR coolant filters may cause severe engine damage.

Cooling System Sealing Additives and Soluble Oils

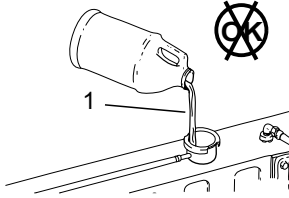

1. Do not use soluble oils or sealing additives.

CAUTION

The use of sealing additives or soluble oils in the cooling system can cause damage to the engine. These additives can plug various areas of the radiator, EGR system and oil cooler. The plugging of the cooling system can hamper heat transfer, causing internal engine damage. **DO NOT** use sealing additives or soluble oils in the cooling system. The use of sealing additives can:

- Build up in coolant low-flow areas
- Plug the radiator and oil cooler

- Damage the water pump seal
- Damage heat transfer surfaces
- Damage seals and hoses
- Corrode brass and copper

Failure to comply may result in equipment or property damage.

Coolant Level

Replacement or top up coolant should have the same antifreeze concentration and corrosion inhibitor content as the original coolant in the cooling system. If operating in sub-freezing conditions, a 60/40 mix of antifreeze and distilled water may be substituted.

Always dilute antifreeze to the correct concentration based on freeze protection before adding it to the cooling system. Adding or using 100% antifreeze in a cooling system may result in cooling system plugging and overheating problems.

This procedure should be followed as part of daily and refueling maintenance checks. Perform the following steps to check the coolant level:

1. Check that vehicle is on a level surface.

2. Ensure engine has not been run for several hours.

CAUTION

Due to thermal expansion the coolant level **CANNOT** be checked if the coolant is above ambient temperature or the engine has not completely cooled. The coolant level indicated on a warmed system will be inaccurate and can lead to low coolant conditions during cold-starts.

3. Check coolant level. It should be visible through the clear plastic surge tank.
4. Add coolant as necessary until proper level is reached; see special fill instruction if filling from empty.

NOTE

The pressure cap (on the rear-top of the surge tank) should **NEVER** be removed. The fill cap (on the ergonomic fill neck, not on the surge tank) is the correct fill point.

Inspect Coolant Level

Inspect the vehicle's coolant surge tank for proper coolant level. Add coolant if the level in the tank is below the line marked **MIN**.

The minimum fluid level is determined by the line on the surge tank indicated by the letters "MIN." This indicator is located below the fill cap. The cooling system will need to be filled if the level is not above the "MIN" line, regardless of engine temperature.

Radiator Mounted Coolant Surge Tank

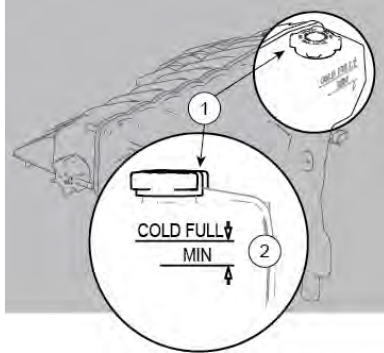

1. Fill location
2. Fill line

How to Add Coolant to the Cooling System

Add coolant through the surge tank fill cap. Do not remove the pressure cap to fill the cooling system.

WARNING

DO NOT remove the radiator fill cap while the engine is hot. Scalding steam and fluid under pressure may escape. You could be badly burned. Failure to comply may result in death or personal injury.

NOTE

If frequent topping off is necessary and there are no visible signs of coolant leaks when the engine is cold, check for leaks with the engine operating at normal temperature.

NOTE

Do NOT use the pressure cap to fill the surge tank with coolant.

NOTE

Do not overfill a cooling system. Excess coolant may result in overflow, loss of antifreeze, and reduced corrosion protection.

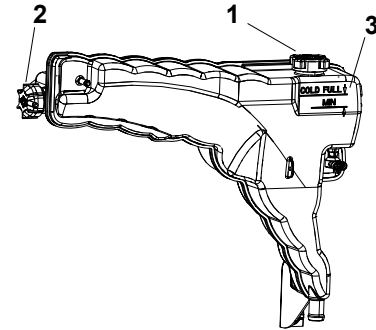

1. Fill cap (service point)
2. Pressure cap (never to be removed)

3. Fill line

1. If your cooling system is built with an air bleed valve in the upper engine coolant pipe, open it before filling the surge tank.
2. Close any open coolant drain valves in the lower engine coolant pipe.
3. Remove the surge tank fill cap (1). DO NOT remove the surge tank pressure cap.
4. Fill the system with premixed coolant through the surge tank fill cap. Pour coolant at a steady flow rate until the surge tank is full (to the "MIN" line). It may be necessary to pause for 1 minute and then re-fill if the fluid level dropped.
5. Close the air bleed valve that was opened in Step 1.
6. Start the engine and idle at low rpm.
7. During low rpm idle, air will purge from the cooling system via the surge tank's coolant fill cap. This will lower the coolant level in the surge tank. Continue to fill the

- surge tank until the coolant level remains approximately 1/2 in. above the "MIN" line. This may take up to 2 minutes, depending on the outside temperature.
8. Operate the engine throttle until the operating temperature stabilizes (when the thermostat opens).
 9. Fill the surge tank as necessary to raise the coolant level to 1/2 in. above the "MIN" level.
 10. Operate the engine at high idle for another 10 minutes and then fill the surge tank again to 1/2 in. above the "MIN" level.
 11. Replace the surge tank fill cap.

Check the coolant level after each trip. Add coolant as necessary. You may find your coolant level is not up to the correct level soon after you have filled the radiator. This may be because all the trapped air in the system has not yet been purged. It takes a little time for all of the air to leave the system after you fill your radiator. Use a solution of half ethylene glycol antifreeze and half water for best heater performance. Do not use more than 60 percent concentration of antifreeze, as a shortened heater life will result.

After servicing the cooling system, monitor the cooling system for several days. Trapped air inside the engine needs time to escape and will lower the coolant level in the surge tank when it does. As part of each pre-trip inspection, look for signs of coolant leaking in the areas that were serviced.



NOTE

If the coolant frequently needs top-ping-up or there are any signs of coolant leakage, consult a PACCAR Service dealer.

Extended Life Coolant

Perform these maintenance procedures according to the Preventative Maintenance Schedule.

- Conduct coolant maintenance checks including freeze point, pH, nitrite and carboxylate tests at least twice annually to maintain engine protection.

Nitrited Extended Life Coolant

For nitrited formulations (NOAT), a heavy-duty extended life coolant that meets

ASTM D6210 and Caterpillar EC-1 specifications must be used. Unless otherwise optioned, factory fill coolant is an ethylene glycol, nitrated organic acid technology (NOAT) extended life coolant (ELC) formulation at a 50:50 coolant-to-distilled water mixture. The factory fill exceeds ASTM D6210 and Caterpillar EC-1 requirements. Maintaining coolant chemistry and freeze protection is critical to engine and cooling system component health and longevity. The change interval for extended-life coolant containing nitrite and molybdate is 750,000 miles (1,200,000 km) or 12,000 hours of on-road use (8 years or 15,000 hours of off-highway use) on initial fill with no extender added. The change interval is 1,000,000 miles (1,600,000 km)/20,000 hours/8 years with an extender addition at 500,000 miles (800,000 km)/10,000 hours/4 years.

Nitrite-Free Extended Life Coolant

Nitrite-free organic acid technology coolant (OAT) may be used if it meets DAF 74002. The change interval for nitrite free coolant is 600,000 miles (1,000,000 km) or 6 years, with no extender needed. DO NOT add coolant extender to nitrite-free coolant. Follow the coolant supplier's drain/flush/fill/

diluting percentages when servicing a vehicle filled with nitrite-free coolant.

Additional Recommendations:

- Antifreeze is essential for freeze, overheat, and corrosion protection. The use of supplemental coolant additives (SCAs) is not recommended for extended-life coolants.

Recommended Extended Life Coolant Suppliers

Authorized PACCAR Engine dealer



Safety Restraint System - Inspection



WARNING

Failure to properly inspect and maintain restraint systems can lead to injury or loss of life. Without periodic inspection and maintenance to detect unsafe conditions, seat restraint com-

ponents can wear out or not protect you in an accident.



WARNING

It is important to remember that any time a vehicle is involved in an accident, the entire seat belt system must be replaced. Unexposed damage caused by the stress of an accident could prevent the system from functioning properly the next time it is needed. Failure to comply may result in death or personal injury.

Seat Belt Inspection Points

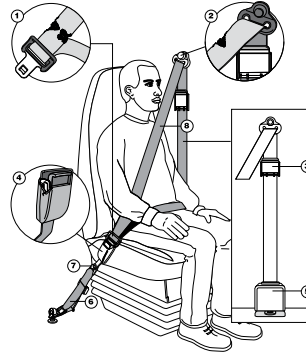

1. Web cut or frayed or extremely worn at latch area
2. Web cut or frayed at D-loop web guide
3. Comfort Clip cracked or damaged
4. Buckle casting broken
5. Retractor Web Storage for damage (located behind trim panel)
6. Tethers for web wear and proper tightness of mounting hardware

7. Mounting hardware for corrosion, proper tightness of bolts and nuts
8. Web for deterioration, due to exposure to the sun

Factors contributing to reduced seat belt life:

- Heavy trucks typically accumulate twice as many miles as the average passenger car in a given time period.
- Seat and cab movement in trucks causes almost constant movement of the belt due to ride characteristics and seat design. The constant movement of the belt inside the restraint hardware and the potential for the belt to come in contact with the cab and other vehicle parts, contributes to the wear of the entire system.
- Environmental conditions, such as dirt and ultraviolet rays from the sun, will reduce the life of the seat belt system.

Due to these factors, the three-point safety belt system installed in your vehicle requires thorough inspection every 20,000 miles (32,000 km). If the vehicle is exposed to severe environmental or working conditions, more frequent inspections may

be necessary. Any seat belt system that shows cuts, fraying, extreme or unusual wear, significant discoloration due to UV (ultraviolet) exposure, abrasion to the seat belt webbing, or damage to the buckle, latch plate, retractor hardware, or any other obvious problem should be replaced immediately, regardless of mileage.

Inspection Guidelines

Follow these guidelines when inspecting for cuts, fraying, extreme or unusual wear of the webbing, and damage to the buckle, retractor, hardware, or other factors. Damage to these areas indicates that belt system replacement is necessary.

 WARNING
<p>Replace the entire belt system (retractor and buckle side) if replacement of any one part is necessary. Unexposed damage to one or more components could prevent the system from functioning properly the next time it is needed. Failure to comply may result in death or personal injury.</p>

1. Check the web wear in the system. The webbing must be closely

examined to determine if it is coming into contact with any sharp or rough surfaces on the seat or other parts of the cab interior. These areas are typical places where the web will experience cutting or abrasion. Cuts, fraying, or excessive wear would indicate the need for replacement of the seat belt system.

2. The pillar web guide (D-loop) is the area where almost constant movement of the seat belt webbing occurs because of relative movement between the seat and cab.
3. Check the Komfort Latch for cracks or possible damage and check for proper operation.
4. Check buckle and latch for proper operation and to determine if latch plate is worn, deformed, or damaged.
5. Inspect the retractor web storage device, which is mounted on the floor of the vehicle, for damage. The retractor is the heart of the occupant restraint system and can often be damaged if abused, even unintentionally. Check operation to ensure that it is not locked up and

that it spools out and retracts webbing properly.

6. If tethers are used, be sure they are properly attached to the seat and, if adjustable, that they are adjusted in accordance with installation instructions. Tethers must also be inspected for web wear and proper tightness of mounting hardware.
7. Mounting hardware should be evaluated for corrosion, and for tightness of bolts and nuts.
8. Check web in areas exposed to ultraviolet rays from the sun. If the color of the web in these areas is gray to light brown, the physical strength of the web may have deteriorated due to exposure to the sun's ultraviolet rays. Replace the system.

Once the need for replacement of the seat belt has been determined, be certain it is only replaced with an authorized PACCAR Parts replacement seat belt. If the inspection indicates that any part of the seat belt system requires replacement, the entire system must be replaced. An installation guide is attached to every replacement belt. Utilize the proper guide for your type of seat, and follow the

instructions very closely. It is vitally important that all components be reinstalled in the same position as the original components that were removed and that the fasteners be torqued to specification. This will maintain the design integrity of the mounting points for the seat belt assembly. Contact your dealer if you have any questions concerning seat belt replacement.

Windshield Wiper/Washer

The windshield wiper system is designed to be maintenance-free. Check wiper blades annually, every 60,000 miles (96,000 km), or when they begin to show signs of wear.

	CAUTION
DO NOT use antifreeze or engine coolant in the windshield washer reservoir, damage to seals and other components will result.	

Washer Reservoir

Daily: Check reservoir water level, located in the engine compartment. If necessary, refill to the proper level.

How to Refill the Washer Fluid Reservoir

1. Park the vehicle and apply the parking brakes
2. Open the hood and secure it in the open position
3. Locate the washer fluid reservoir and open the filler cap. It will be located in one of two places:
 1. Passenger side (RH) in front of the steer tire - 2.4 Gallons (9 Liters) capacity
 2. Drivers side (LH) on top of the radiator - 2.0 Gallons (7.6 Liters) capacity
4. Fill the reservoir with windshield washer fluid and replace the cap
5. Close and secure the hood

Electrical System

	WARNING
Battery posts, terminals and related accessories contain lead and lead compounds, chemicals known to the State of California to cause cancer and reproductive harm. Wash hands after handling.	

	WARNING
Before attempting any work on the batteries or electrical system, remove all jewelry. If metal jewelry or other metal comes in contact with electrical circuits, a short circuit may occur causing you to be injured, as well as electrical system failure and damage.	



CAUTION

DO NOT modify or improperly repair the vehicles electrical system or power distribution box. All electrical repairs should be performed by an authorized dealer. Improper repair or modifications will void your warranty and/or cause serious damage to your vehicle.



CAUTION

Wait at least 10 minutes after the key switch is turned OFF before disconnecting battery power. The system uses battery power to circulate DEF and prevent overheating of the DEF system. Failure to comply may result in property damage.

5

Engine Aftertreatment System Power Requirements

The engine aftertreatment system uses battery power for up to 10 minutes after the ignition is turned off. After the ignition turns off, the engine aftertreatment system circulates DEF to help cool down the fluid and prevent overheating. For situations where the battery will be disconnected (i.e. for service or maintenance of the vehicle), please wait 10 minutes before disconnecting battery power.

Low Voltage Disconnect (LVD) (option)

The Low Voltage Disconnect (LVD) may increase battery life and avoid depleting the battery below the minimum charge needed to start the engine by shutting off non-vital battery loads.

When battery voltage drops below the LVD setting, LVD starts a two-minute countdown. If battery voltage remains below the LVD setting and the engine is not started, when the countdown ends, all non-vital battery loads (hotel loads) will be shut off. The LVD setting is adjusted in the Settings sub-menu of the Digital Display.

When battery voltage drops below the LVD setting

1. An amber LVD Popup notification occurs, accompanied by an audible warning. This starts the two-minute countdown.
2. Thirty seconds before the countdown ends, the Battery Voltage indicator is replaced by the amber (or red) LVD telltale²³. The LVD popup notification will turn red and will be accompanied by a continuous audible warning.



3. When the two-minute countdown has ended, the LVD "Hotel Loads Disconnected" Popup appears, and LVD shuts off all loads connected through the LVD system.

The LVD condition will not clear until battery voltage increases above the LVD setting or the engine is started.

²³ On the 15 inch display, LVD telltale color depends on the severity of battery depletion.

Electrical loads shut off by LVD

- Cab dome lamps
- Cab accessories
- Spare LVD wiring for customer added accessories



WARNING

DO NOT use the Spare Battery A and B circuits or other circuits that are controlled by the LVD to power electronic engine controls, ABS circuits, or safety/work related lighting. Before adding any device to the vehicle's electrical system, consult your nearest authorized dealer or read the contents of TMC RP136. Failure to do so may cause equipment damage or lead to personal injury.



NOTE

The determination of what circuits/loads that were connected to the LVD was based upon the recommendation from Technology and Maintenance Council (TMC) of the American Truck-

ing Association. To review the recommended practice, see TMC RP-136.



NOTE

All LVD circuits are color-coded blue on the central electrical panel cover label.

Vehicle Light Bulb specifications

Bulb Location	Type of Bulb	Notes
Low beam halogen	H11-LL (SAE), H7 (ECE)	(Long life version not required)
Low beam HID	D1-S	
High beam halogen	HB3A – LL	(Long life version not required)
Daytime running lamp/ position lamp/ turn signal/	4157K (SAE), 3157K (ECE)	N/A

Bulb Location	Type of Bulb	Notes
halogen side marker lamp		

Aiming Headlights

The headlights were properly aimed at the factory to meet safety specifications. If the headlights need to be adjusted, please have an authorized dealership aim the headlights.

How to Change the Headlight

This procedure applies to headlight pods that are mounted to the side of the hood.



WARNING

Optional HID headlights have high voltage circuits and should only be serviced by a trained technician. Attempting to service the HID ballast without proper training may result in severe electrical shock which could lead to death or personal injury.

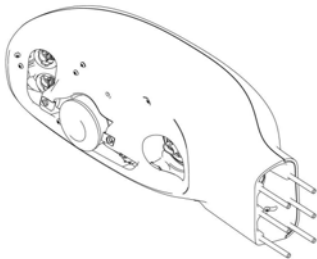

5

1. Remove the back cover plate from the back side of the headlight pod using a standard Phillips head screw driver.
2. Turn the bulb lock ring counterclockwise and remove the bulb.

Do not allow the glass of the new headlamp bulb to come into contact with anything. The glass could become contaminated and cause bulb failure.

3. Reassemble in reverse order.

Fuses, Circuit Breakers and Relays

Fuses, circuit breakers, and relays are located in the Power Distribution Box to the left of the steering column behind the clutch pedal. Additional fuses are located

in the engine compartment (drivers side bulkhead) and also in the sleeper (left side of vehicle) under bunk storage compartment.

Altering the Electrical System

Refer to a wiring diagram for your chassis before adding electrical options to ensure proper electrical system performance.



WARNING

DO NOT replace a fuse with a fuse of a higher rating. Doing so may damage the electrical system and cause a fire. Failure to comply may result in property damage, personal injury, or death.



WARNING

Never install a circuit breaker/polyswitch in a location indicated for "fuse only." Using a polyswitch (circuit breaker) in a fuse-only circuit may cause the circuit to overheat when a short exists, which could lead to equipment damage and/or personal injury.



NOTE

Polyswitches/circuit breakers are allowed in certain locations as indicated by the label on the fuse box. In these applications, a fuse may be used instead of a circuit breaker.



CAUTION

Follow all manufacturers' circuit protection recommendations for the components and wires being added. Failure to comply may result in equipment damage.



NOTE

If you are unfamiliar with proper electrical repair practices and procedures, see your authorized dealer for assistance.

Vehicle CAN Bus

Your vehicle is equipped with a CAN bus electrical system. Because of how the

electrical system is designed it is important that any accessories added after the vehicle is built are installed only on the K-CAN or the S-CAN. These dedicated CANs are provided on the driver's side of the cab, near to the interior fuse panel. Access to the K-CAN and S-CANs is provided by two RP1226 connectors. DO NOT tap into, connect to, tamper with, or splice into any CAN network other than the K-CAN or the S-CAN. Connecting to a unapproved CAN network may trigger CAN fault codes.



CAUTION

Connecting to an unapproved CAN network may trigger CAN fault codes. The manufacturer will not warrant failures or damage caused to CAN network components when the failure or damage is a result of improper connections to the CAN network.



CAUTION

The use of scotch locks, scraped off insulation, and electrical tape are not approved CAN connection techniques.

These are the source of numerous CAN faults.

Scotch locks

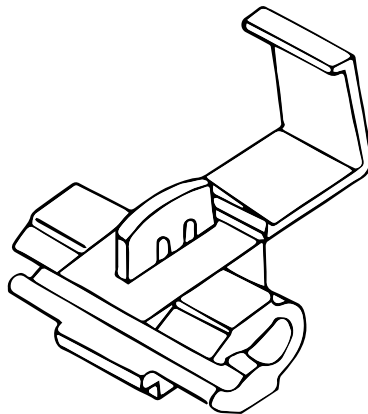

Batteries

Regular attention to the charging system will help prolong the service life of the batteries.



WARNING

Batteries contain acid that can burn and gases that can explode. Ignoring safety procedures may result in death, personal injury, equipment or property damage.



WARNING

Never remove or tamper with battery caps. Ignoring this could allow battery acid to contact eyes, skin, fabrics, or painted surfaces. Failure to comply may result in property damage, personal injury, or death.



CAUTION

DO NOT store other items in the battery box. Failure to comply could result in damage to the truck and/or batteries.



CAUTION

Properly secure battery tie downs and battery box cover when reinstalling batteries after service. DO NOT over tighten. Over tightening can crack the battery case which can lead to equipment damage.



CAUTION

The Diesel Exhaust Fluid (DEF) system recirculates fluid to the doser to prevent damage from heat after key off. If your vehicle is equipped with battery disconnect switches do NOT disconnect battery power within TEN minutes of switching the ignition key off. Failure to comply may result in vehicle or property damage.

Here are some common causes of battery failure:

Overcharge: this condition results from improper voltage regulator adjustment. It results in overheating of the battery, warped plates, and evaporation of electrolyte.

Undercharge: the voltage regulator is malfunctioning, the drive belt is slipping, or your vehicle has undergone long periods of idling or short distance driving. These conditions result in battery plates becoming covered with a hard coating.

Vibration: loose battery hold-downs may cause battery plate failure.

Short Circuits: these discharge the battery by draining electricity.

Dirty or Loose Connections: improper connections may stop the flow of electrical power to and from the battery.

Battery Charging



WARNING

Batteries can injure you severely. They contain acid, produce poisonous and explosive gases, and supply levels of electric current high enough to cause burns. A spark or flame near a battery on charge may cause it to explode with great force. Never remove or tamper with the battery caps. Failure to comply may result in property damage, personal injury, or death.

Except for using small trickle charges to maintain battery condition, you should

have your vehicle's batteries charged by a qualified service facility. To help reduce the risk of personal injuries, follow these guidelines carefully when recharging a battery:

- Before attempting any service in the electrical installation, disconnect the battery negative cable.
- Allow no sparks or open flame anywhere near the charging area.
- Charge a battery only in a well-ventilated area, such as outdoors or in a fully open garage which contains no pilot lights or other flames. Gases generated during the charging process must be allowed to escape.
- Always make sure the battery charger is OFF before connecting or disconnecting the cable clamps.
- To avoid short circuits, damage to the vehicle, or personal injury, never place metal tools or jumper cables on the battery or nearby. Metal that accidentally comes in contact with the positive battery terminal or any other metal on the vehicle (that is in contact with the

positive terminal), could cause a short circuit or an explosion.

Charging Reminders

- Use protective eyewear
- Keep all batteries away from children
- Never reverse battery poles
- Never attempt to place the vehicle in motion, or run the engine with batteries disconnected
- Keep the battery clean and dry
- Look for any signs of damage
- Battery terminals should not be coated with improper grease. Use a commercially available, noncorrosive, non-conductive terminal coating, or petroleum jelly.
- Never use a fast charger as a booster to start the engine. This can seriously damage sensitive electronic components such as relays, radio, etc., as well as the battery charger. Fast charging a battery is dangerous and should only be attempted by a competent mechanic with the proper equipment.

Under Cab Battery Access

The battery compartment is located on the left side of the vehicle, under the cab access steps.

1. Remove the six bolts that are located in the two cab access step plate.
2. Remove battery cover for access.

In Cab Battery Access

Your vehicle may be equipped with Absorbed Glass Mat (AGM) batteries located in the cab under the passenger's seat. The glass mat in AGM batteries are designed to absorb the battery acid inside the battery that can leak or spill out in conventional batteries. This design feature allows batteries to be positioned in any orientation without risk of leaking.

To access the batteries:

1. Enter the cab.
2. Remove six fasteners securing the passenger side seat base to the battery box assembly.
3. Remove the seat and seat base as one unit to gain access to the batteries.
4. Installation is the reverse of removal.

Cranking Battery Specification

Category	Specification
Group	31
Stud Type	Threaded
Cold Crank Amps	650
Voltage	12 V
Reserve Capacity	160 minutes
General	Maintenance free

Removing Batteries

After accessing the batteries, follow these steps to remove them from the vehicle.

CAUTION

Wait at least 10 minutes after the key switch is turned OFF before disconnecting battery power. The system uses battery power to circulate DEF and prevent overheating of the DEF system. Failure to comply may result in property damage.

1. Be sure all switches on the vehicle are turned OFF
2. Wait 10 minutes after turning ignition off before disconnecting the batteries
3. Disconnect negative (-) ground cable first
4. Disconnect positive (+) cable
5. Unscrew the holding plate bolts with an open end wrench

 NOTE

Always dispose of automotive batteries in a safe and responsible manner. Contact your authorized dealer for disposal standards. Call your local authorized recycling center for information on recycling automotive batteries.

Follow the procedures below to reinstall batteries on the vehicle and replace parts removed for access.

Installing Batteries

Follow the procedure below to reinstall main batteries on the vehicle:

 NOTE

Always dispose of automotive batteries in a safe and responsible manner. Contact your authorized dealer for disposal standards. Call your local authorized recycling center for information on recycling automotive batteries.

 NOTE

Make sure to reconnect the ground (negative) cable last.

 WARNING

Battery replacement may alter or disturb battery cable routing. Check to insure battery cables are free from any point of chaffing. Failure to comply may result in death, personal injury, equipment or property damage.

1. Place batteries in vehicle and tighten bolt of holding plate
2. Reconnect positive cable

3. Reconnect ground (negative) ground cable

Replace Battery Box Cover

 WARNING

Always reinstall steps before entering the cab or accessing the deck plate. Without steps you could slip and fall. Failure to comply may result in personal injury or death.

 WARNING

Fairings not installed properly could come loose and cause other motorists to have an injury accident. It is important that fairings be installed properly. Failure to comply may result in death, personal injury, equipment or property damage.

1. Replace battery cover.
2. Install two bolts in step strut. Torque to 24-32 lb-ft (33-43 N·m).
3. Install fairing and install four bolts. Torque to 6-7 lb-ft (8-9 N·m).

4. Install steps by installing two bolts in each step. Torque to 24-32 lb-ft (33-43 N·m).

Slow Battery Charging

 WARNING
<p>Charger cables must be connected positive to positive (+ to +) and negative to negative (- to -). If connected improperly, batteries could explode. Failure to comply may result in property damage, personal injury, or death.</p>

 WARNING
<p>Always make sure the battery charger is OFF before connecting or disconnecting the cable clamps. To reduce the danger of explosions and resulting death or personal injury, do not connect or disconnect charger cables while the charger is operating.</p>

 NOTE
<p>Some vehicles may have an ultra capacitor mounted in the battery box. These devices have a similar shape to a battery but have two positive posts and one negative posts. Do not attach battery chargers to these devices to recharge the vehicles batteries. Connect directly to the conventional two post charging batteries to charge them.</p>

 NOTE
<p>Follow the instructions that come with your battery charger.</p>

1. Access the battery terminals, the batteries do not have to be removed from the vehicle.
2. Make sure the battery charger is turned off.
3. Disconnect the battery cables.
4. Connect charger cables.
5. Start charging the battery at a rate not over 6 amperes. Normally, a battery should be charged at no

more than 10 percent of its rated capacity.

6. After charging, turn OFF charger and disconnect charger cables.

Alternator

Take the following precautions to avoid burning out alternator diodes:

- DO NOT start the engine with alternator disconnected (connections removed) from the circuit.
- Before welding, disconnect all electronic connections to the vehicle batteries.
- Remove battery power cable and insulate it from the vehicle.
- DO NOT run the engine with the batteries disconnected.
- DO NOT disconnect the battery cables or alternator connection cables with the engine running
- Never turn the ignition switch from the ON position to the START position with the engine running.
- When charging the battery (installed in the vehicle) disconnect the battery cables.

- DO NOT reverse the cables of the alternator, starter motor, or battery.
- DO NOT polarize the alternator. The alternator should not be polarized like a generator. To ensure correct polarity, use a test lamp or a voltmeter.

Remote Keyless Entry

The system will lock or unlock cab doors with the key fob. The system will alert you with parking lights when the selected doors are locked or unlocked. There are two key fobs provided with the system which provide secure rolling code technology that prevents someone from recording the entry signal.

If you have issues with a key fob, replace the battery and reprogram the key fob. In some situations, the key fob may need to be replaced and in others, a fuse may have failed that could render both key fobs inoperative. Contact your dealer for help if a key fob does not work and it is not because of a bad battery.

The key fob uses one CR2032, 3V battery. Batteries should last approximately three years, depending on use. Consistently reduced range is an indicator that the battery needs replacement. Batteries are

available at most discount, hardware, and drug stores. The battery can be accessed by removing the cover of the key fob. After a new battery is installed, the key fob may need to be reprogrammed to pair with the vehicle.

Quantity	Type
1	CR2032

How to replace key fob battery

If the key fob will not unlock the doors, replace the battery.

1. Remove the cover of the key fob.
2. Replace the battery and dispose of the old battery.
3. Check to see if the key fob is still paired to the vehicle. If not, reprogram the key fob.

Programming Key Fobs

The key fob may need to be paired with the truck when the battery is replaced or when the key fob has not been used for an extended period of time.

1. Turn the ignition switch to the ON position.
2. Open the driver and passenger doors.
3. Press and hold the passenger door's unlock button for 5 seconds, then release the button.
4. Within 3 seconds press and hold the passenger door's lock button for 5 seconds, then release the button. At this time you should hear the vehicle cycle the locking system by unlocking, then relocking the doors. (This indicates that the door module has entered "learning mode.")
5. Within the next 10 seconds, press and hold the key fob's lock button for 5 seconds, (you should hear the vehicle lock the doors) then press and release the unlock button.
6. Once programming is complete (or the 10 seconds from Step 5 has passed), the vehicle will cycle the locking system twice (unlock, lock, unlock, lock). This process should be repeated for each fob to be paired with the module. A maximum of five key fobs may be paired to a single module.

Engine Maintenance

These topics relate to the operator maintenance tasks for the engine. Information provided here is in addition to information contained in the Engine Operator Manual supplied with the vehicle.



WARNING

Exhaust fumes from the engine contain carbon monoxide, a colorless and odorless gas. DO NOT breathe the engine exhaust gas. A poorly maintained, damaged, or corroded exhaust system can allow carbon monoxide to enter the cab. Entry of carbon monoxide into the cab is also possible from other vehicles nearby. Failure to properly maintain your vehicle could cause carbon monoxide to enter the cab, resulting in personal injury or death.



WARNING

NEVER start or let the engine run in an enclosed, unventilated area. Exhaust fumes from the engine contain

carbon monoxide, a colorless and odorless gas. Carbon monoxide can be fatal if inhaled. Failure to comply may result in property damage, personal injury, or death.



WARNING

Never idle your vehicle for prolonged periods of time if you sense that exhaust fumes are entering the cab. Investigate the cause of the fumes and correct it as soon as possible. If the vehicle must be driven under these conditions, drive only with the windows open. Failure to repair the source of the exhaust fumes may result in death, personal injury, equipment or property damage.



NOTE

Keep the engine exhaust system and the vehicle's cab ventilation system properly maintained. It is recommended that the vehicle's exhaust system and cab be inspected (1) By a competent technician every 15,000 miles

(24,140 km); (2) Whenever a change is noticed in the sound of the exhaust system; or (3) Whenever the exhaust system, underbody, or cab is damaged.

Check Engine Oil Level



WARNING

Hot engine oil can be dangerous. You could be burned. Let the engine oil cool down before changing it. Failure to comply may result in death, personal injury, equipment or property damage.



NOTE

It takes approximately 15 minutes for all the oil to run into the sump when the engine is warm. If the level is checked immediately after switching off the engine, the dipstick will show a low oil level.

1. Make sure that the vehicle frame rail is standing on a flat and level surface.
2. Make sure that the vehicle is horizontal, both lengthwise and crosswise. Check this carefully on a vehicle with air suspension. Note that the engine may be inclined up to 4 degrees, depending on the vehicle model and wheelbase.
3. Twist the dipstick handle to unlock it, then pull the dipstick out of the holder.

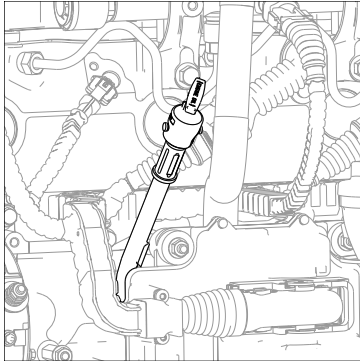

4. Wipe the dipstick clean with a lint-free cloth.

5. Place the dipstick back into the holder.
6. Pull the dipstick out again and check the oil level. The oil level should always be between the two marks on the dipstick.

Engine Oil Dip Stick Markings

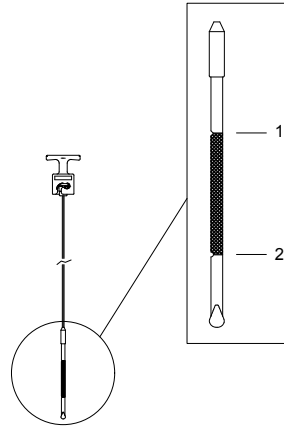

1. High oil level (1)
2. Low oil level (2)
7. Reinstall the dipstick and twist to lock it in place.

Topping Up the Engine Oil

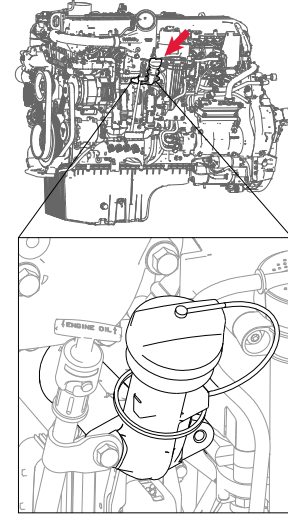

1. Top up with oil, if necessary, via the filler opening. Use the correct grade in the correct quantity. For oil replacement, please see engine Operator's Manual included with this chassis.
2. After topping up, wait 1 minute and check the oil level again.

3. Reinstall the oil fill cap and twist to lock it in place.

Install Engine Belt

You can extend the reliability and service life of your vehicle's drive belts with proper attention to installation and maintenance. Neglect could cause belt failure. The result could be the loss of the electrical or air system as well as possible engine damage from overheating.



NOTE

See the engine manufacturer's operator's manual for further information on replacing engine drive belts.

The images below may not appear like the configuration of the vehicle. The procedure is still the same. Follow this procedure to install an accessory drive belt:

1. Route the new belt around the pulleys, and then rotate the automatic tensioner so that the idler pulley swings toward the belt routing. The following figure shows an example of the rotation direction to release the tensioner.

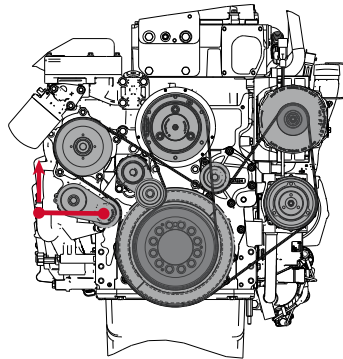
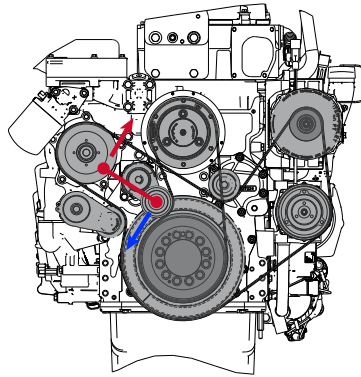

2. Slip the belt around the idler pulley attached to the automatic tensioner.
3. Release the automatic tensioner.
4. Check the belt alignment on each pulley. The belt must fall between the flanges of each pulley.

Engine Fan



WARNING

DO NOT work on or near the fan with the engine running. Anyone near the engine fan when it turns on could be injured. If it is set at MANUAL, the fan will turn on any time the ignition key switch is turned to the ON position. In AUTO, it could engage suddenly without warning. Before turning on the ignition or switching from AUTO to MANUAL, be sure no workers are near the fan. Failure to comply may result in death or personal injury.

Follow these guidelines to check your engine fan:

- With the engine shut off, check the fan hub bearings for looseness, loss of lubricant, and any abnormal

conditions (e.g. fan belt misaligned or excessive wear/damage, etc.).

- With the engine idling and the hood open, stand at the front of the vehicle. Listen for any noises coming from the fan hub. Bearings that have lost lubricant and are dry will typically emit a squeal or a growl when the engine is at operating temperature and the fan clutch is engaged. If noise is detected, have the fan bearings inspected by an authorized dealership.

Engine Fan Blade

Verify that there is enough fan blade clearance with the fan shroud. The recommended distance around the fan shroud is 1 in. (25 mm) from front edge of any fan blade-to-radiator side member. Minimum clearance is 3/4 in. (19 mm).

- Rear edge of any blade must be no closer than 3/8 in. (9 mm) to the nearest engine component. If this cannot be obtained, the fan spacer or fan is incorrectly placed.
- The leading edge of any fan blade must be 1 in. (25 mm) from the inside edge of the shroud.

Air Intake System

Engine heat, vibration, and age combine to loosen air intake connections and cause cracks in the tubing and elbows. Leaks in the intake system allow abrasive dust to enter the engine and quickly cause expensive damage. During your daily walk-around inspection, carefully check all tubing, elbows, clamps, supports, and fasteners for condition and tightness. Check the charge-air-cooler for air leaks annually. The air leaks can be caused by cracked tubes or header. For service see your authorized dealer.



CAUTION

DO NOT use air intake pipes and connections as a step or to pull yourself up. This could loosen the connections and open the system to unfiltered air which could damage the engine.

Turbocharger



WARNING

DO NOT operate engine with turbocharger intake piping disconnected. A suction is created when the engine is running. This suction could draw your hand or anything else near it into the impeller fan. You could be injured. Always keep the intake piping connected when you will be running the engine.

When servicing the air intake and exhaust systems on a turbocharged engine, check the items listed below:

Lubricating System

Check the oil lines, housing, and connections. Look for leaks, damage, or deterioration. Leaks could mean you have damaged oil lines or oil seals.

Manifold

With the engine operating, check for leaking manifold or flange gaskets.

High Frequency Vibration

Vibration may indicate turbo rotor imbalance. Have your dealer investigate

this immediately. If you detect any deficiencies, take the vehicle to an authorized dealer for servicing. Delay could lead to severe and expensive damage to your vehicle.

Air Cleaners



WARNING

DO NOT use air filter housings as grab handles. These components may break if you are using them to support your weight. Failure to comply may result in personal injury or damage to vehicle components.



CAUTION

Failure to replace air filter at proper intervals may result in passage of dirt/debris into the engine or the “dusting” of an engine resulting in significant equipment damage.

Service the air cleaner filter elements as specified in the [Component Specific Intervals](#) on page 178. This vehicle is equipped with an air inlet restriction

indicator. Service the filter elements when the air inlet restriction indicator locks in the extreme Up position. Paper elements require care and proper handling because they are critical to engine service life. If your vehicle has an external air cleaner and cab-mounted mirrors, the mirror must be pivoted to provide access for servicing the filter element.

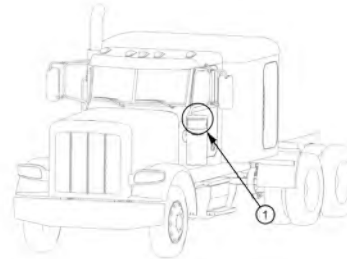

Replacing the Engine Air Intake Filter

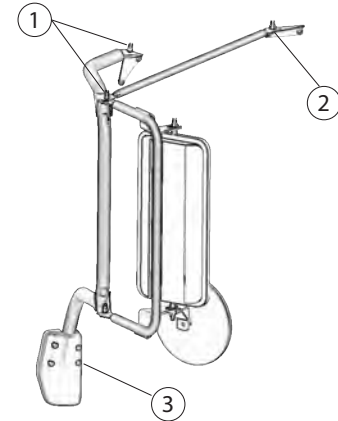

1. Steps 1 and 6
 2. Steps 2, 5, and 6
 3. Steps 3 - 7
1. Loosen (do not remove) upper 5/16 in. mounting hardware.
 2. Remove acorn nut and flat washer, then pivot upper stabilizer rod away from cab.

- Loosen the two rearmost M6 hex socket head screws on the lower clamp.



NOTE

The two forward screws secure the cover to the base. The two rearmost screws provide the clamping force on the main support tube.

- Rotate the main support tube rearward to provide clearance to remove and replace the air cleaner filter element.



CAUTION

To prevent possible engine damage, torque the four hex nuts attaching the air cleaner cover assembly to the body assembly to 8 lb-ft (10 N·m) after installing the new air cleaner filter element.

- After installation of the new filter element, rotate the main support tube forward and reinstall the upper stabilizer rod to its mounting bracket.

- In any sequence, tighten the upper fasteners to a torque of 13 - 17 lb-ft (17 - 23 N·m).
- Tighten the two rearmost screws in the lower clamp to a torque of 4 - 4.5 lb-ft (5 - 6 N·m).

Exhaust System

The exhaust system is part of the noise and emission control system. Periodically check the exhaust system for wear, exhaust leaks, and loose or missing parts. For details on how to maintain the emissions components in the exhaust system, see "Noise and Emission Control" in your vehicle operator's manual. Please refer to the engine operator's manual for more details on how to maintain the emissions components in the exhaust system.

Engine Mounting



CAUTION

DO NOT re-torque or reuse existing flange head bolts. These bolts are factory set to the specified torque. If bolts

are loose or damaged, they must be replaced with the new bolts. Failure to comply may result in property damage.

Periodic Inspection: Inspect engine mounts every 60,000 miles (96,000 km). Check for the following:

- Inspect both mount and leg fasteners. Check for loose or broken bolts. Replace as necessary.
- Check mount and leg for fractures, breaks or deformation. Replace as necessary.
- Check for complete insertion of motor mount. Replace as necessary.
- New leg to mount flange head bolts should be torqued to 210-230 lb-ft (284-311 N·m).

Fuel System

Location of Fuel Shut-off Valves

Fuel shut-off valves for the fuel crossover line are on the bottom of the secondary fuel tank, at the crossover line connection. They are optional on the primary fuel tank.

Specification

Use only diesel fuel as recommended by engine manufacturers.

 **WARNING**

Diesel fuel in the presence of an ignition source could cause an explosion. A mixture of gasoline or alcohol with diesel fuel increases this risk of explosion. DO NOT remove a fuel tank cap near an open flame. Use only the fuel and/or additives recommended for your engine. Failure to comply may result in death, personal injury, equipment or property damage.

 **CAUTION**

If anyone ever pours gasoline into your fuel tank, drain the entire system. Otherwise, the pump and engine will be damaged. DO NOT try to dilute the gasoline by adding diesel fuel (see Warning above).

Fuel Filters

See Engine Manufacturer's Operator Manual provided with this chassis.

Draining the Primary Fuel Filter

The following tools are suggested for this procedure:

- Container (1 liter capacity) (optional)
- 3/8" diameter rubber hose (optional)

Perform with engine OFF. Cover any electrical equipment and wiring that might get soaked with fuel – diesel fuel may permanently damage electrical insulation. If draining to replace filter, drain into container with a minimum 1 liter (1 qt) capacity, and use hose to route fluid.

1. Open the hood (see [How to open the hood](#) on page 17), and locate the primary fuel filter.
2. Open drain valve (by hand only) until draining occurs. If draining to replace the filter, before opening valve, push one end of hose onto drain valve and route other end to the container.
3. Drain fluid from filter assembly:

- If draining water from fuel, drain filter bowl of water until clear fuel is visible, then close drain valve, or
- If replacing filter, drain until flow stops, then close valve.

 **CAUTION**

Do not overtighten the valve. Over tightening can damage the threads.

If a hose was used to drain fluid, remove hose.

If entire filter assembly was drained, proceed to Replacing the Primary Fuel Filter.

Replacing the Primary Fuel Filter

The following tools are suggested for this procedure:

- Bowl wrench RK61680
- 1" wrench
- New PACCAR primary fuel filter element designed for this application
- 2 new O-rings

Start procedure with engine off. Cover any electrical equipment and wiring that might get soaked with fuel; diesel fuel may permanently damage electrical insulation. To expel air from density-type strainer elements, soak them in clean fuel before installing them. Lubricate new O-rings with clean fuel to ensure a positive seal.

1. Disconnect clip-type electrical connections from bowl bottom:
 - a. Disconnect water in fuel (WIF) sensor from wire bundle.
 - b. Disconnect electrical heater sensor from wire bundle.
2. Using bowl wrench, loosen filter bowl and lower at least 2 inches. Take care not to damage bowl sensors on surrounding components.
3. Slowly remove bowl and filter from upper filter assembly.
4. Remove the filter element and both upper and lower O-rings.
5. Install new filter element:
 - a. Install new upper and lower O-rings.
 - b. Install new fuel filter element.
6. Reconnect clip-type electrical connections to bowl bottom:
 - a. Reconnect water in fuel (WIF) sensor to wire bundle.
 - b. Reconnect electrical heater sensor to wire bundle.
7. If your vehicle has a fuel blending valve, turn valve to "Prime."
8. Allow the electric priming pump to prime assembly.
9. Start the vehicle.
10. If your vehicle has a fuel blending valve, turn valve to "Run."

Observe fuel filter assembly for leaks. Dispose of old filter element and O-rings properly.

Fuel Tank

Check the strap tightness: tighten to proper torque value as required; aluminum tank - 30 lb-ft (41 N·m) cylindrical steel tank - 8 lb-ft (11 N·m.)

Frame



WARNING

DO NOT cut, splice or weld frame rails or drill through the top or bottom flang-

es of the rails. These operations could affect frame rail strength leading to a failure resulting in an accident. Rail failures resulting from such modifications are not warrantable. Failure to comply may result in property damage, personal injury, or death.



WARNING

Frame welding is NOT recommended. The high heat of welding nullifies the special heat treatment of the rails, greatly reducing the tensile strength of the frame rail. If a frame member becomes cracked from overloading, fatigue, surface damage, or a collision, the only permanent repair is to replace the damaged frame member with a new part.

Emergency Welding

In an emergency, a temporary repair may be performed. Observe the following precautions to protect electronic systems during welding operations. Emergency welding procedures are further explained in the maintenance manuals. Please refer to

the ordering information on the back cover to obtain a maintenance manual. In the event of emergency welding of a frame rail and when welding any other part of your truck or any component attached to your truck, observe the following precautions before welding:

- Disconnect all electronic devices. It is not possible to list all of the electronics that could be affected, but a few examples include the following: alternator, engine Electronic Control Unit (ECU), transmission ECU, ABS ECU, navigation devices, diagnostic devices, and monitoring devices.
- Disconnect battery cables and insulate them from the vehicle.
- Do not use the ECU or engine ground stud for the ground of the welding probe.
- Ensure that the ground connection for the welder is as close to the weld point as possible. This ensures maximum weld current and minimum risk to damage of electrical components on the vehicle.

Painting

Do not electrostatically paint your truck or any component on your truck without first removing all of the electronic components from the truck. It is not possible to list all of the electronics that could be affected, but a few examples include the alternator, engine Electronic Control Unit (ECU), transmission ECU, ABS ECU, navigation devices, diagnostic devices, and monitoring devices.

Fifth Wheel Monthly Maintenance

- Refer to specific manufacturer's literature for any special instructions
- Steam clean the fifth wheel
- Check lock guard operation using a commercial lock tester
- Clean and oil all moving parts
- Lubricate the lock mechanism with a lithium-base grease
- All grease fittings (especially those which grease the top surface of the fifth wheel)

Fifth Wheel Bi-Annual Maintenance

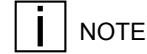

Whenever possible, torque all frame fasteners on the nut end, not the bolt head.

- Refer to specific manufacturer's literature for any special instructions.
- Remove fifth wheel from vehicle. Refer to the Shop Manual, "Fifth Wheel Removal."
- Steam clean the fifth wheel and mounting brackets.
- Check all moving parts for excessive wear or damage. Replace all worn or broken parts.
- Complete two-month service procedure.
- Install fifth wheel. Refer to the Shop Manual, "Fifth Wheel Installation."

Tighten all frame fasteners with a torque wrench. See [Frame Fastener Torque Requirements](#) on page 279.

Sliding Fifth Wheels

Lubricate bearing surface of support bracket through the grease fittings on the side of the fifth wheel plate. Use a water resistant lithium-base grease.



NOTE

The plate must be lifted up slightly to relieve the weight of the bracket while applying grease.

Front Axle and Suspension

Axle Lubrication

Refer to the axle manufacturer's operator's manual for lubrication specifications and service intervals.

Kingpin Lubrication

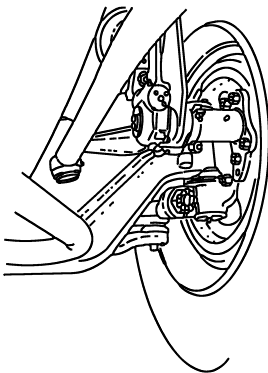

Lubricate with approved lubricant. Lubricate knuckle thrust bearings, knuckle pins, and tie rod ends. Lack of lubrication causes premature wear and hard steering. Lubrication schedule may be shortened if necessary.

Suspension Lubrication

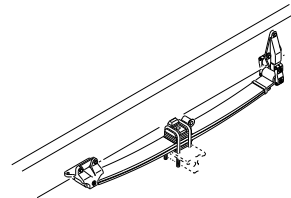

Each standard spring anchor pin has a grease fitting. Pressure lubricate spring pins as specified. At regular intervals, the spring leaves may be lubricated with a rust-inhibiting oil applied with a spray gun or brush. Depending on your suspension, lubricate all spring pins until grease flows out of both ends of the bushing. Look for signs of rust or water in the flushed grease. If a pin will not accept grease, it should be removed, cleaned, and inspected.



CAUTION

DO NOT spray the suspension with chemical products or mineral oil; it can cause damage to the bushings.

Inspection

For all vehicles, mandatory maintenance procedures include retightening all U-bolts and inspecting the suspension for loose, damaged, or abnormally worn fasteners. Visually inspect the shock absorbers, the rubber bushings, the leaf springs, and that the suspension is aligned and functioning properly. Mono leaf spring suspensions should also have their rear shackle brackets checked for proper alignment. Even with proper maintenance, however, the service life of leaf springs are affected by many factors: fatigue, vehicle gross weight, type of load, road conditions, and vehicle speed. Check for cracks, wear marks, splits, or other defects on the surface of the spring. Defective parts must be replaced. Because repaired springs cannot be fully restored to their original service life, replace the complete assembly if cracks or other defects are detected.

Wheel Alignment

For driving safety and comfort, and to prolong the life of your vehicle, it is important to have wheels correctly aligned. Check tire wear frequently. Uneven tire wear is a sign that the wheels may be misaligned. If you see uneven wear, take

your vehicle to an authorized dealer familiar with aligning wheels on your vehicle.

Suspension U-Bolts

It is important that U-bolts remain tight. Severe use of your vehicle will cause them to loosen faster, and all vehicles need to have their U-bolts checked and tightened regularly. Be sure someone with the proper training and the right tools checks and tightens the U-bolts on your vehicle. New springs can settle in after service, relieving the tension on the U-bolts. Loose U-bolts can cause leaf spring breakage, axle misalignment, hard steering, and abnormal tire wear. All vehicles should have suspension U-bolts tightened after the first 500 miles (800 km) of operation. Re-torque the front spring pinch bolts and shackle pinch bolts.

vehicle control and an accident. Loose U-bolts can also cause uneven tire wear and poor alignment. Failure to comply may result in death, personal injury, equipment or property damage.

U-bolts are difficult to tighten unless you have the right equipment. If you cannot tighten them correctly yourself, be sure to have them checked and tightened regularly by an authorized mechanic. Tighten U-bolt nuts to the specified torque value with the vehicle loaded to its normal gross weight. See [Suspension U-Bolts, Grade 8](#) on page 280 specifications for torque values applying to U-bolts and nuts.



WARNING

DO NOT operate the vehicle if the suspension U-bolts are not properly tightened. Loose U-bolts will cause the axle to not be properly secured to the suspension, which could cause loss of



WARNING

DO NOT replace U-bolts and nuts with common U-bolts or standard nuts. These parts are critical to vehicle safety. If the wrong U-bolts or nuts are used, the axle could loosen or separate from the vehicle and cause a serious accident. Use only U-bolts and nuts of SAE Grade 8 specification or better. Failure to comply may result in death, personal injury, equipment or property damage.

5

PACCAR 20k Front Axle Lubrication

Proper lubrication practices are important in maximizing the service life of the steer axle assembly.

Kingpins, Thrust Bearings, and Tie Rod Ends

On-Highway Applications - Standard

- Pressure lubricate every 6 months or 25,000 miles (40,000 km).
- A more frequent lubrication cycle is required for axles used in on/off-highway, refuse, or other severe service applications. Use heavy-duty, multipurpose lithium base (#2 grade) grease.



NOTE

DO NOT mix with sodium-based grease.

PACCAR 20k Front Axle Lube Points

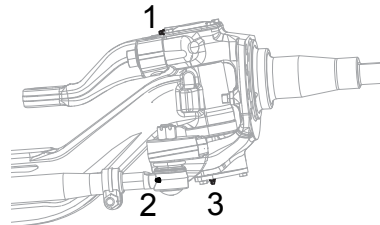

1. Upper kingpin bearing
2. Tie rod end
3. Lower kingpin bearing



NOTE

If it is difficult to grease either the upper or lower bearing, try greasing the bearings with the vehicle jacked up and supported on axle stands to improve grease flow and flush contamination.

Oil Bath

Lubricate wheel end assembly with a drive axle lubricant that meets MIL-L-2105D specifications. Either SAE 80W-90 mineral based or 75W-90 synthetic gear oil is acceptable. Check the lubricant level at each greasing interval. Maintain the lubrication fluid level at centerline of axle or fill line on hub cap. Always check fluid level on flat ground.



CAUTION

Never mix oil bath and grease-packed wheel ends. Mixing oil and grease will reduce the effectiveness of both lubricants and may cause damage to the wheel ends.

Heater and Air Conditioner Maintenance

The combination heater-air conditioner provides comfort for those in the cab through accurate control of the cab environment in all weather conditions. Regular attention to the items below will help you keep the heater-air conditioner unit running well. Keep the vehicle's ventilation system, engine exhaust system, and cab joints properly maintained. It is recommended that the vehicle's exhaust system and cab be serviced by a competent technician as follows:

- Inspected every 15,000 miles
- Whenever a change is noticed in the sound of the exhaust system

- Whenever the exhaust system, vehicle underbody, or cab is damaged

To allow for proper operation of the vehicle ventilation system, proceed as follows:

- Keep the inlet grille at the base of the windshield clear of snow, ice, leaves, and other obstructions at all times.
- Keep the exhaust pipe area clear to help reduce the buildup of exhaust gas under the vehicle.
- Check the drain tube of the fresh air inlet for trapped water before assuming that there is a leak in the heating system.

Special Precautions



WARNING

Excessive heat may cause the pressurized components of the air conditioning system to explode. Never weld, solder, steam clean, or use a blow torch near any part of the air conditioning system. Failure to comply may result in death, personal injury, equipment or property damage.



WARNING

Air conditioning refrigerant can be hazardous to your health. DO NOT expose yourself to leaking refrigerant for prolonged periods near excessive heat, open flames, or without proper ventilation. Failure to do so may result in death or personal injury.

If a refrigerant leak develops in the presence of excessive heat or an open flame, hazardous gases may be generated. If you become aware of a refrigerant leak on your vehicle have your system serviced immediately and observe the following precautions: Stay away from the hot engine until the exhaust manifold has cooled. Do not permit any open flame in the area. Even a match or a cigarette lighter may generate a hazardous quantity of poisonous gas. Do not smoke in the area. Inhaling gaseous refrigerant through a cigarette may cause violent illness.

Heater



CAUTION

During extreme cold weather, DO NOT blow hot defroster air onto cold windshields. This could crack the glass. Turn the Air Flow Control Dial to Defrost and adjust the fan speed accordingly while the engine warms. If the engine is already warm, move the Temperature Control Dial to "cool," then gradually increase the temperature when you see that the windshield is starting to warm up. Failure to comply may result in equipment damage.

- Check all heater controls for full-range operation.
- Check hoses, connections, and heater core for condition and leaks.

Air Conditioner



WARNING

The air conditioning system is under pressure. If not handled properly during servicing, it could explode. Any servicing that requires depressurizing

and recharging the air conditioning system must be conducted by a qualified technician with the right facilities to do the job. Failure to comply may result in death, personal injury, equipment or property damage.



WARNING

Wear eye protection any time you blow compressed air. Small particles blown by compressed air could injure your eyes.

- Listen to the compressor and drive clutch for noise and vibration. If you find problems, have the system checked thoroughly. A malfunctioning clutch usually indicates trouble elsewhere in the system.
- Check the evaporator core, filter, and condenser core for debris restricting air flow. Clean if necessary. Small particles may be removed with compressed air blown through the core in the opposite direction of normal air flow.

- Check the engine belt for condition and proper tension.
- Check all hoses for kinks, deterioration, chafing, and leaks. Adjust kinked or chafing hoses to eliminate restrictions and prevent further wear.
- Check all components and connections for refrigerant leaks. If you discover a leak, do not try to tighten a connection. Tightening a connection may cause a leak to worsen. Have a qualified technician correct the problem.



NOTE

A leaking evaporator or condenser core cannot be repaired; it must be replaced.

Have the air conditioning system fully serviced annually by your authorized dealer. Qualified service technicians will have to evacuate and recharge the system.

How to Replace Air Conditioner Filter

Noise and Emission Control

There are specific components on the vehicle that are designed to meet certain Environmental Protection Agency (EPA) emissions and noise regulations. To maintain conformance with the regulations, these components need to be functional and properly maintained.

Noise Emission Warranty

Peterbilt warrants to the first person who purchases this vehicle for purposes other than resale and to each subsequent purchaser that this vehicle as manufactured by Peterbilt, was designed, built, and equipped to conform at the time it left Peterbilt's control with all applicable U.S. EPA Noise Control Regulations. This warranty covers this vehicle as designed, built, and equipped by Peterbilt, and is not limited to any particular part, component, or system of the vehicle manufactured by Peterbilt. Defects in design, assembly, or in any part, component, or system of the vehicle as manufactured by Peterbilt, which, at the time it left Peterbilt's control, caused noise

emissions to exceed Federal standards, are covered by this warranty for the life of the vehicle.

Tampering with Noise Control System

Federal law prohibits the following acts or the causing thereof:

1. The removal or rendering inoperative by any person other than for purposes of maintenance, repair, or replacement, of any device or element of design incorporated into any new vehicle for the purpose of noise control prior to its sale or delivery to the ultimate purchaser or while it is in use, or
2. The use of the vehicle after such device or element of design has been removed or rendered inoperative by any person. Among those acts presumed to constitute tampering are the acts listed below:

Air Intake System	Removing or rendering inoperative the air filter housing/silencers or intake piping
Engine Cooling System	Removing or rendering the fan clutch inoperative Removing the fan shroud

Engine Removing or rendering engine speed governor inoperative so as to allow engine speed to exceed manufacturer's specifications
Modifying ECU parameters

Exhaust System Removing or rendering inoperative exhaust system components

Fuel System Removing or rendering engine speed governor inoperative, allowing engine speed to exceed manufacturer's specifications
Removing of air signal attenuator on engines equipped with this device
Removing of diesel exhaust fluid tank and system

Inner Fender Shields and Cab Skirts Removing shield or skirts
Cutting away parts of shields, skirts or damaged or loose portions of shields or skirts

Noise Insulating Blankets Removing noise insulators from engine block or from around the oil pan
Cutting holes in, or cutting away part of noise insulators
Removing hood-mounted noise insulation

Inspecting Noise and Emission Components

If, during periodic inspection and maintenance of other systems and components, it is found that parts of the noise control system require attention, we recommend that those parts be inspected at more frequent intervals to assure adequate maintenance and performance. The following instructions are based on inspection of the noise control system at regular intervals as indicated in the [Noise Control System - Maintenance Log](#) on page 283.

Air Intake System

- Do all checks and maintenance procedures listed in this manual under engine air intake system and air filter housing.
- Check the induction tubing, elbow connections, clamps, brackets, and fasteners for deterioration, cracks, and security.
- If you find an air leak anywhere between the air filter housing and the engine, repair that leak immediately.

CAUTION

Air leaks cause excessive noise and may result in serious damage to the engine. If you do not repair them the engine damage will not be covered by your warranty. Repair all air leaks as soon as you find them.

Engine Mounted Noise Insulators

- Check condition. Is the insulator secure? How you do this will depend on the method of attaching the noise insulators on the engine and around the oil pan (bolts, snap fasteners, or straps). Tighten loose fasteners and repair or replace any worn or damaged fasteners.
- Check insulators around fasteners and stress points, especially where they may be affected by engine vibration. Repair any cracked or damaged mounting points. Use suitable reinforcing plates to ensure that the insulators will remain in position.

Exhaust System

- Check for exhaust leaks, which would indicate a leaking manifold

gasket; replace gasket if necessary.

- Check cap screws for tightness, including those at the flanges. Refer to the engine manufacturer's service manual for proper tightening sequence and torque values.

Joints and Clamps

- Check for leaks, and tighten as necessary. Check for deterioration or dents in pipes and clamps which could allow exhaust to escape.
- Replace any serviceable joints, flexible pipes and gaskets at the service intervals.

Selective Catalysts Reduction (SCR)

- Check SCR canister filter, clamps and mounting brackets. Tighten if necessary. Inspect SCR canister for signs of rust or corrosion.

Exhaust Piping

- Check exhaust piping for rust, corrosion, or damage. Replace deteriorated piping before holes appear. If piping is perforated at any point, temporary patching or lagging is acceptable until you can have permanent repairs made. On turbocharged engines, check joints

at flanges and mounting brackets for tightness.

Diesel Particulate Filter (DPF)

- Check DPF, clamps, and mounting brackets. Tighten if necessary. Inspect DPF for signs of rust or corrosion.
- Check internal baffling. You can do this by listening for rattling sounds while tapping on the (DPF with a rubber mallet or revving the engine up and down through its normal operating range.

DEF Tank (See Aftertreatment System manual)

Exhaust Tail Pipe

Engine Fan and Shroud

Hood Insulation Blanket

Inner Fenders Shields and Cab Skirts

Diesel Exhaust Fluid (DEF) Tank Straps

During normal operation of the truck, the DEF tank straps may relax. Inspect the spring on top of the strap. If more than 1/2" (12.7mm) of the spring is exposed, the bolt will need to be re-torqued between 70 – 80 in-lbs. (7.9 – 9 Nm). This distance (1) is

measured from the washer at the end of the spring to the edge of the tube at the top of the straps.

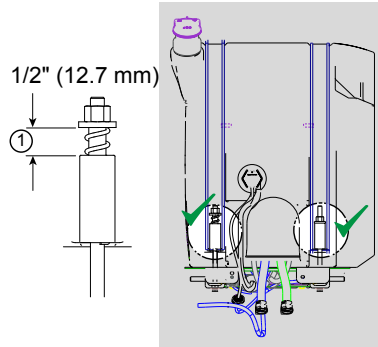

See Engine Operator's Manual for DEF filter maintenance interval.

Rear Axle and Suspension

Your vehicle's suspension, by design, requires a minimal amount of maintenance. However, suspensions in over-the-road operations require periodic inspection to ensure trouble-free performance.



WARNING

DO NOT work on the vehicle without the parking brake set and wheels blocked securely. If the vehicle is not secured to prevent uncontrolled vehicle movement, it could roll and may result in death, personal injury, equipment or property damage.



WARNING

DO NOT operate the vehicle if the suspension U-bolts are not properly tightened. Loose U-bolts will cause the axle to not be properly secured to the suspension, which could cause loss of vehicle control and an accident. Loose U-bolts can also cause uneven tire wear and poor alignment. Failure to comply may result in death, personal injury, equipment or property damage.



WARNING

Failure to maintain the specified torque values or to replace worn parts can cause component system failure, possibly resulting in an accident. Improperly tightened (loose) suspension U-bolts can lead to unsafe vehicle conditions, including: hard steering, axle misalignment, spring breakage or abnormal tire wear. Failure to comply may result in death, personal injury, equipment or property damage.



CAUTION

DO NOT spray the suspension with chemical products or mineral oil; it can cause damage to the bushings.



NOTE

Failure to follow these recommendations could void warranty.

Visual Inspection

For all vehicles, mandatory maintenance procedures include retightening of U-bolts and complete inspection. Even with proper maintenance, however, many factors affect the service life of springs and suspension components: fatigue, vehicle gross weight, type of load, road conditions, and vehicle speed. All vehicles need to have their U-bolts checked and tightened regularly, but severe use of your vehicle can cause them to loosen faster. It is important that U-bolts remain tight. Be sure someone with proper training and the right tools checks and tightens the U-bolts on your vehicle. After the first 500 miles (800 km) of operation, periodically inspect the suspension as noted below:

- Visually check for loose or missing fasteners, cracks in hanger, or axle connection brackets
- Check that springs are centered in hangers and in good condition
- Check for cracks, wear marks, splits, or other defects on the surface of the spring
- Replace defective parts. Because repaired springs cannot be fully restored to their original service life, replace the complete assembly

if cracks or other defects are detected

- After replacement of any part or discovery of loose components, check the torque of all fasteners
- New springs settle-in after the vehicle's initial service, causing the U-bolts to become loose

Rear Suspension Fasteners

To maintain the performance of the air suspension, check fastener torque values after the first 2,000 miles (3,200 km) of service and every 60,000 miles (96,000 km) thereafter. Torque recommendations apply to fasteners supplied and installed by vehicle manufacture. The values listed at the back of this chapter (See [Suspension U-Bolts, Grade 8](#) on page 280 and [Frame Fastener Torque Requirements](#) on page 279), are for cadmium plated or phosphate and oil fasteners only.

Rear Suspension U-Bolts

U-bolts are difficult to tighten unless you have the right equipment. If you cannot tighten them correctly yourself, be sure to have them checked and tightened regularly by an authorized mechanic.



NOTE

To ensure an accurate torque reading, use properly maintained and calibrated torque wrenches. Clean the nut and bolt. No dirt, grit, or rust should be present.



WARNING

DO NOT operate the vehicle if the suspension U-bolts are not properly tightened. Loose U-bolts will cause the axle to not be properly secured to the suspension, which could cause loss of vehicle control and an accident. Loose U-bolts can also cause uneven tire wear and poor alignment. Failure to comply may result in death, personal injury, equipment or property damage.



NOTE

Whenever possible, torque all frame fasteners on the nut end, not the bolt head.

Load the vehicle to its normal gross weight before tightening U-bolts. Loading the vehicle ensures proper adjustment of the U-bolt and spring assembly.



WARNING

DO NOT replace U-bolts and nuts with common U-bolts or standard nuts. These parts are critical to vehicle safety. If the wrong U-bolts or nuts are used, the axle could loosen or separate from the vehicle and cause a serious accident. Use only U-bolts and nuts of SAE Grade 8 specification or better. Failure to comply may result in death, personal injury, equipment or property damage.

Rear Axle Lubrication

See the axle manufacturer's operator's manual for lubrication specifications and service intervals. Check oil level with the vehicle parked on level ground and the fluid warm. The level should be even with the bottom of the filler hole.

Rear Axle Alignment

Continual road shock and load stresses may force the rear axles out of alignment. If you detect rapid tire wear on the rear axles, you may have misaligned axles. If you suspect rapid tire wear, have your rear axle alignment checked and adjusted by an authorized dealer.

Suspension alignment should be checked when any one of the following conditions exist:

- Total vehicle alignment required after a body has been installed on truck chassis.
- Discovery of loose suspension fasteners (Loose, defined as any torque below the recommended torque value)
- Discovery of elongated holes in a suspension component
- Bushing replacement
- Excessive or abnormal tire wear
- Immediately after post body installation (See First Day in the Maintenance Chapter)

Drive Axle - Dana

Drain the lubricant while warm. Flush each unit with clean flushing oil. Change the lubricant.

Eaton/Dana Axle Lubrication

- The original mineral-based lubricant must be drained within 3,000-5,000 miles (4,800-8,000 km) on all Eaton axles. This initial change is very important because it

flushes out break-in contaminants that might otherwise cause premature wear.

- No initial drain is required on Eaton axles that are factory filled with an Eaton-approved synthetic lubricant.
- Mineral-based lubes must be drained within the first 5,000 miles (8,000 km) if converting to an Eaton-approved synthetic lube.

- Change the lubricant within the first 5,000 miles (8,000 km) of operation after a carrier head replacement, regardless of the lubricant type.
- Refer to the *Eaton Field Maintenance Manual* for a particular axle for lubricant specifications.
- See your dealer for Eaton-approved lubricant brands.
- Refer to the chart below for lubricant change interval.

Type of Lubricant	On-Highway Mi. (km)	Maximum Change Interval	On/Off Highway Severe Service Mi. (km)	Maximum Change Interval
Mineral-Based	120,000 (192,000)	Yearly	60,000 (96,000)	Yearly
Eaton-Approved Synthetic	240,000 (384,000)	2 Years	120,000 (192,000)	Yearly
Eaton-Approved Synthetic in axle with extended drain interval option	350,000 (560,000)			

Drive Axle - Meritor

Drain and replace the lubricant.

Meritor Axle Lubrication

	NOTE
<p>Axles utilized in 100% off-highway use are not eligible for Meritor's Advanced Lube Rear Drive Axle program.</p>	

Under Meritor's Advanced Lube Rear Drive Axle program, the axles listed below are exempt from an initial lubricant change:

Available Advanced Lube Axles

RS-19-145	RS-26-180	RT-40-145P	RT-46-160
RS-21-145	RS-30-180	SQ-100A	RT-46-160P
RS-23-160	RT-34-145	SQ-100AP	RT-52-160
RS-23-161	RT-34-145P	RT-44-145	RT-52-160P
RS-17-145	RS-23-180	RT-40-145	RT-44-145P

Meritor rear axles that do not appear on the list above will continue to require an initial drain at 3,000-5,000 miles (4,800-8,000 km).

- Refer to the *Meritor Field Maintenance Manual* for a particular axle for lubricant specifications.
- See your dealer for Meritor-approved lubricant brands.
- Refer to the following chart for lubricant change intervals:

Application	Type Of Lubricant	Mileage Interval
On Highway	Synthetic	240,000 mi. (384,000 km)
	Synthetic with Pump and Filter	500,000 mi. (800,000 km)
	Mineral Base	120,000 mi. (192,000 km)
City Delivery	Synthetic	120,000 mi. (192,000 km)
	Synthetic with Pump and Filter	240,000 mi. (384,000 km)
	Mineral Base	120,000 mi. (192,000 km)
Off Highway	Synthetic	120,000 mi. (192,000 km)
	Synthetic with Pump and Filter	120,000 mi. (192,000 km)
	Mineral Base	120,000 mi. (192,000 km)

- Change the lubricant filter every 120,000 miles (192,000 km). Top off the lubricant level with a similar lubricant

Drive Axle - SISU Breather and Brakes

1. Check the breather for proper operation.
2. Overhaul the brakes: degrease all moving parts, check the bushings and seals for wear.

Drive Axle (SISU) Inspection

1. Check the wheel bearing hubs and adjust if necessary.
2. Visually inspect for damage or leaks.

Drive Axle (SISU) Oil Servicing

Change the oil in the differential carrier and the hubs, and clean the magnetic oil drain plugs.

Drive Axle - SISU Lube Filter

Clean the suction filter for the optional pressure lubrication system.

Steering System

 **WARNING**

DO NOT operate the vehicle if the steering system is not working properly. You could lose control of your vehicle if the steering system is not in good working condition, which could result in a serious accident. For driving safety, visually check the steering gear and components. Frequent checks are important for driving safety, especially after traveling over rough roads. Failure to comply may result in personal injury, property damage, or death.

 **WARNING**

If this chassis is equipped with an electronic stability system (ESC) and any part of the steering system (e.g., linkage, steering driveline, column, front end alignment, etc) is repaired, removed, or disassembled in any way, or if the steering angle sensor is replaced, the steering angle sensor must

be recalibrated. Any repairs or adjustments to any part of the steering system must be performed by an authorized dealer. Failure to comply may result in personal injury, property damage, or death.

Hydraulic fluid (under low pressure) provides the power to operate the steering gear. It also serves to lubricate moving parts and remove heat. A loss of steering efficiency will occur if too much heat builds up in the system.

If the steering feels unbalanced from side-to-side while turning, check for the following possible causes:

- Unequal tire pressures
- Vehicle overloaded or unevenly distributed load
- Wheels out of alignment
- Wheel bearings improperly adjusted

If you cannot correct the problem, check with an authorized dealer.

Your vehicle is equipped with integral power steering. The system includes an engine-driven fluid pump, a fluid reservoir, the steering gear, and connecting hoses. Because of the hydraulic power assist, little effort is required to turn the steering wheel.

When no input is applied through the steering wheel, the steering gear will return to the neutral position. If, for any reason, the power assist system goes out, steering the vehicle is still possible but it will require much greater effort.

Visually check the following parts:

- Crosstube: Is it straight?
- Drag link tube clamp: Check for looseness or interference
- Ball joints and steering U-joints: Check for looseness
- Steering wheel for excessive free-play. Check the simplest probable causes first: (A) unequal tire pressures; (B) loose cap nuts; (C) bent crosstube; or (D) lack of lubrication

If these checks do not reveal the problem, or if you correct them and still have a steering problem, take your vehicle to an authorized dealer for evaluation.

Check Power Steering Fluid Level



CAUTION

When adding fluid, be sure to use fluid of the same type. While many fluids have the same description and intended purpose, they should not be mixed due to incompatible additives. Mixing incompatible fluids may lead to equipment damage.



NOTE

Before removing reservoir cap, wipe the outside of the cap so that no dirt or debris falls into the reservoir.

Check the fluid level. Use the following procedure:

1. Park the vehicle on level ground and turn the engine off.
2. Open the hood.
3. Check the fluid level on the reservoir.

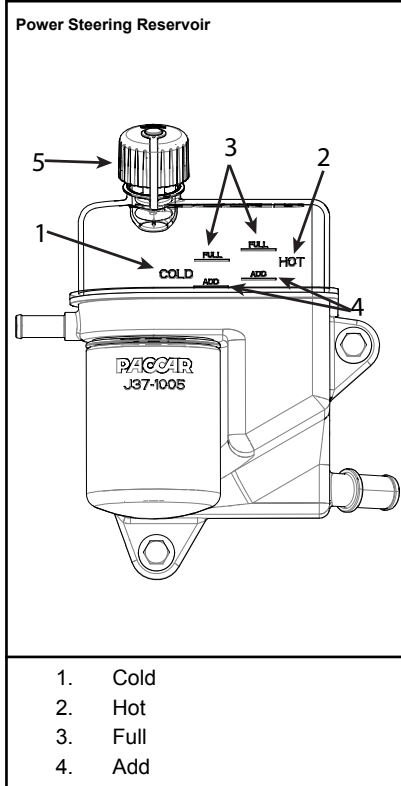

5. Fill cap

- If you check the fluid with the engine and steering system COLD, the fluid level should be above the Add indicator level and should generally not exceed the middle point between the Add and Full level indicators.
 - If you check the fluid with the engine and steering system WARM, the fluid should NOT exceed the Full level indicator and should generally not drop below the middle point between the HOT Full and Add level indicators.
4. To add fluid, open the fill cap to the power steering reservoir and then add fluid until the fluid level is in the middle of the appropriate Minimum and Maximum level indicators.
 5. Reinstall the reservoir fill cap and close the hood.

Steering Shaft Bolt Torque Specifications

The steering (intermediate shaft) U-joint pinch bolt should be tightened on the first day or two of operation, then checked weekly (see Weekly Checks). The following are common torque specifications for most steering shafts.

Steering U-joint Pinch Bolt

Fastener Size	Torque Spec. lb-ft (N•m)
7/16 -in.	37-43 (50-58)

Pitman Arm Clamp Bolt

Fastener Size	Torque Spec. lb-ft (N•m)
3/4 -in.	300-320 (406-433)

 **WARNING**

If this chassis is equipped with an Electronic Stability Control (ESC) and is modified (e.g. adding or removing an axle, converting from a truck to a tractor, converting from a tractor to a truck, changing the body, lengthening of the wheelbase and/or frame, relocating frame components, or modifying pneumatic or electrical ABS/ESC harnesses) the ESC must be evaluated by a qualified technician. If you have any questions, contact your authorized dealer. Failure to comply may result in property damage, personal injury, or death.

 **WARNING**

Improper lubrication of U-joints can cause them to fail prematurely. The driveshaft could separate from the vehicle and result in an accident. Make sure lubricant is purged at all four ends of each U-joint and loosen caps if necessary. Also, regularly inspect U-joints for excessive wear or movement, and repair or replace as necessary. Failure to comply may result in death, personal injury, equipment or property damage.

Driveline

See the driveshaft manufacturer's operator's manual for lubrication specifications and service intervals.

Tires

Your tires are a very important part of your vehicle's whole braking system. How fast you can stop depends mostly on how much friction you get between the road and your tires. In addition, keeping your tires in good condition is essential to the safe, efficient operation of your vehicle. Regular, frequent inspection and the right care will give you the assurance of safe and reliable tire

operation. Here are some tips on maintaining your tires.

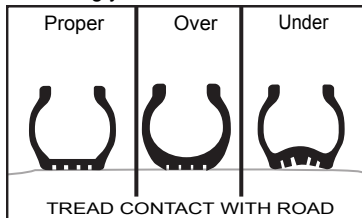

WARNING

DO NOT repair damaged tires unless you are fully qualified and equipped to do so. Wheel and tire assemblies cannot be worked on without proper tools and equipment, such as: safety cages or restraining devices. Have all tire repairs performed by an expert. Stand away from the tire assembly while the expert is working. Failure to do this may result in death or injury.

Checking Inflation Pressure

Low pressure is a tire's worst enemy. Underinflation allows tires to flex improperly, causing high temperatures to build up. Heat causes early tire damage

such as flex break, radial cracks, and ply separation. Low pressure may affect control of your vehicle, especially at the front wheels. Most tire wear problems are caused by underinflation as the result of slow leaks, so check tire pressure regularly. Lower tire pressure does not provide better traction on ice or snow. Give your tires a visual test every day, and check inflation with a gauge every week:

- When checking tire pressure, inspect each tire for damage to sidewalls, cuts, cracks, uneven wear, rocks between duals, etc. If a tire appears underinflated, check for damage to the wheel assembly. Don't forget to check between dual wheels. If you find wheel damage, have an expert tire service repair it.
- Maximum tire pressure will be indicated on the sidewall of a tire.
- Check pressure only when the tires are cool. Warm or hot tires cause pressure buildup and will give you an inaccurate reading. So never deflate a warm tire to the specified pressure.



WARNING

DO NOT operate a vehicle with under-inflated tires. The extra heat caused by underinflation can cause sudden tire failure such as a tire fire or blow out, which can cause an accident resulting in death or personal injury. Low pressure may affect control at the front wheels, which could result in an accident involving death or personal injury. Keep your tires inflated to the manufacturer's recommended air pressure.



WARNING

DO NOT attempt to raise the vehicle to remove or install a damaged tire and wheel assembly if you are not fully qualified and not equipped with the proper tools and equipment. DO NOT attempt to reinflate a tire that has been run flat. Obtain expert help. A person can be seriously injured or killed if using the wrong service methods. Truck tires and wheels should be serviced only by trained personnel using proper equipment. Follow OSHA regulations per section 1910.177.



NOTE

Follow all warnings and cautions contained within the tire and wheel manufacturers literature.

Overloaded Tires

Overloading your truck is as damaging to your tires as underinflation. The following chart shows how neglect or deliberate abuse can affect the life of your tires.

Effects of Load and Pressure on Tire Life

Vehicle Load	Tire Pressure	Expected Total Tire Mileage
Normal	Normal	Normal
20% Over	20% Low	70%
40% Over	30% Low	50%
60% Over	35% Low	40%
80% Over	45% Low	30%
100% Over	55% Low	25%

Overinflated Tires

Overinflating the tires reduces the tread contact area with the road surface, concentrating all of the vehicle weight on the center of the tread. This causes premature wear of the tire.



WARNING

Overinflated tires can cause accidents. They wear more quickly than properly inflated tires and are more subject to punctures, cracks, and other damage. They could fail and cause you to lose control of your vehicle resulting in an accident causing death or personal injury. Be sure all tires are inflated correctly according to the manufacturer's recommendations.

Matching Tires

Be sure to buy matched tires for your vehicle, especially on the rear axles. Mismatched tires can cause stress between axles and cause the temperature of your axle lubricant to get too hot. Matched tires will help your driveline last longer and will give you better tire mileage.



WARNING

DO NOT mismatch tires, it can be dangerous. Never mix tires of different design such as steel belted radials and bias ply tires, etc. Mixing tire types and sizes will adversely affect the road holding ability of both types of tires and can lead to loss of vehicle control and causing death or personal injury.



WARNING

DO NOT install regrooved or reinforcement repaired tires on steering axles. They could fail unexpectedly and cause you to lose control of your vehicle resulting in an accident causing death or personal injury.

Replacing Tires

Front: Replace front tires when less than 4/32 -in. of tread remains. Check at three places equally spaced around the tire.
 Drive Axles or Trailers: Replace tires on drive axles or trailers when less than 2/32 -in. of tread depth remains in any major

groove. Check at three places equally spaced around the tire.



WARNING

DO NOT replace original equipment tires with load ratings less than the original tires. Doing so could lead to unintentional overloading of the tire, which could cause a failure resulting in loss of vehicle control and an accident. Failure to comply may result in death, personal injury, equipment or property damage.



NOTE

To prolong your tires' life and make them safer, have their radial and lateral run-out checked at your dealer. And of course you should have your tires balanced anytime you change a tire.

Tire Chains

If you need tire chains, install them on both sides of each driving axle.



NOTE

To prolong your tires' life and make them safer, have their radial and lateral run-out checked at your dealer. And of course you should have your tires balanced anytime you change a tire.

Speed Restricted Tires



WARNING

This vehicle is equipped with speed restricted tires. Check each tire's sidewall and/or tire manufacturer's data book for maximum rated speed. The vehicle should not be operated at speeds in excess of the maximum rated speed. Failure to comply with these speed restrictions could cause sudden tire failure, which can result in property damage or personal injury.

Greenhouse Gas Certified Tires

	<p>NOTE</p>
<p>The tires installed on this vehicle at the factory as original equipment are certified for Greenhouse Gas and Fuel Efficiency regulations. Replacement tires must be of and equal or larger loaded drive tire size and equal or lower rolling resistance level (TRRL or Crr). Consult with your tire supplier(s) for appropriate replacement tires.</p>	

In order to limit the rolling resistance of the tires and optimize fuel economy, the maintenance procedures specified by the tire manufacturer must be followed. Please see Vehicle Emissions Limited Express Warranty for warranty on greenhouse gas certified tires.

Wheels

After the vehicle travels about 50 to 100 miles (80 to 160 km), wheel mountings seat in and will lose some initial torque. Check hub/wheel mountings after this initial period and retighten. Threads should

be clean and dry. Do not lubricate wheel nuts or studs.

	<p>WARNING</p>
<p>Never use oil or grease on studs or nuts; improper torque readings will result, which could cause improper wheel clamping and could lead to a wheel failure resulting in an accident. Failure to comply may result in death, personal injury, equipment or property damage.</p>	

Wheel Replacement with Disc Brake Option

	<p>WARNING</p>
<p>Use only the wheel brand, size and part number originally installed. Use of a different wheel brand or size could cause valve stem to interfere with a brake component which could lead to loss of vehicle control. Failure to comply may result in death, personal injury, equipment or property damage.</p>	

Vehicles equipped with front disc brakes are fitted with wheels designed specifically

for disc brake applications. If it ever becomes necessary to replace an original equipment wheel, the replacement wheel must be the same brand and size as the take-off wheel. On vehicles equipped with 22.5 in. disc wheels, installing the wrong replacement wheel could result in the wheel valve stem making contact with the disc brake assembly. When installing any replacement wheel, always inspect the tires/wheels to ensure there is adequate clearance between other vehicle components. With the hood open, check for clearance between the wheel and disc brake assembly. Use a hydraulic jack to raise the front of the vehicle off the ground to allow the wheel to spin freely. While rotating the wheel, check to ensure there is adequate clearance between the wheel and disc brake assembly.



WARNING

Improperly mounting and demounting tire and rim assemblies is dangerous. Failure to observe proper precautions could cause the tire rim assembly to burst explosively, causing death or personal injury. See the wheel manufacturer's literature for the proper way to mount and demount your tires and rims. Follow their precautions exactly.



WARNING

Always ensure the hood hold open latch is engaged to keep the hood fully open any time anyone gets under the hood for any reason. Failure to do so may cause the hood to close uncontrollably which may result in death or personal injury.



WARNING

Always support the vehicle with appropriate safety stands if it is necessary to work underneath the vehicle. A jack is

not adequate for this purpose. Failure to comply may result in death, personal injury, equipment or property damage.

Disc Wheels



WARNING

Use the correct components and tools when working on wheels. Grooves in the wheel disc or other damage to the disc can weaken the wheel and cause it to eventually come off. This could cause you to lose control of your vehicle, and may result in an accident. Failure to comply may result in property damage, personal injury, or death.

The end of the wheel wrench must be smooth. Burrs on the end of the wrench can tear grooves in the disc. These grooves may lead to cracks in the disc, and can cause it to fail.

Wheel Bearings

Service the bearings, seals and oil. This interval may be different depending on the results of the regular inspection. 350,000 mi (560,000 km). For safe, reliable

operation and adequate service life, your wheel bearings must be adjusted properly at the recommended intervals. Contact your authorized dealer to make sure the wheel bearings are properly adjusted.

Transmission Maintenance

See the transmission manufacturer's operator's manual for lubrication specifications and service intervals.



CAUTION

When adding oil, types and brands of oil should not be intermixed because of possible incompatibility, which could decrease the effectiveness of the lubrication or cause component failure.

Fuller Transmission Lubrication

Fuller transmissions are designed so that the internal parts operate in a bath of oil circulated by the motion of gears and shafts. Grey iron parts have built-in channels where needed to help lubricate bearings and shafts. All parts will be amply

lubricated if these procedures are closely followed:

1. Maintain oil level; check it regularly.
2. Change oil regularly.
3. Use the correct grade and type of oil.
4. Buy oil from a reputable dealer.

Lubrication Change and Inspection Off-Highway Use

Refer to the Eaton Fuller transmission manual for servicing information.

Highway Use

- Refer to the Eaton Fuller transmission manual for servicing information.
- Refer to the oil change vs. temperature chart that follows for special oil change information. The "intermittent peak temperature" is the maximum temperature observed for a short time in a fully loaded vehicle performing normally.

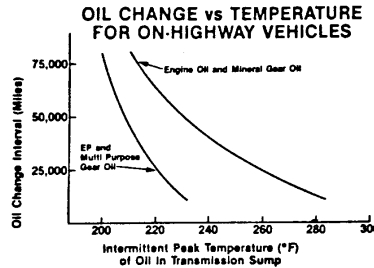

CAUTION

Exceeding the recommended oil change intervals may be harmful to the life of the transmission and the transmission oil cooler.

Mechanical Clutch

The clutch in this vehicle is actuated via a combination of mechanical linkages from the cab to the transmission.

Free Pedal Travel

Free pedal travel is the distance the clutch pedal moves by applying only slight

pressure. During free pedal the release yoke in the transmission moves until its bearing pads contact the release bearing. This movement of the release yoke is called free travel. Thus, free pedal and free travel are directly related to each other. As the clutch pedal is depressed further, with harder pressure, the release yoke moves the release bearing away from the engine. This causes the clutch plate to release from the driven disks in the clutch. This is called release travel. And finally, as the pedal is pushed to the last 1/2 to 1 inch of travel, the release bearing contacts and engages the clutch brake. This is called clutch brake squeeze. When the clutch wears, the release bearing gradually moves toward the engine, decreasing free pedal and free travel. When all free pedal and free travel are gone, the clutch requires adjustment. The clutch is adjusted by turning an adjustment ring that is built into the clutch. When the ring is turned, the release bearing moves back toward the transmission, restoring free pedal and clutch free travel. Under normal clutch wear this is the only adjustment needed. Do not attempt to change any other component.

Clutch Linkage

Have your authorized dealer service the clutch according to the clutch manufacturer's service guidelines. This vehicle is equipped with a rod and lever mechanical clutch linkage. Lubricate each pivot point on the clutch linkage. Replace with the recommended fluid Component Lubrication Index. [Lubrication Specification Chart](#) on page 276

Clutch Adjustment

Clutch pedal free travel is usually 1 3/4 in. to 2 in. (34 to 51 mm). This should be your

guide for determining whether your truck needs clutch adjustment. Some vehicles have automatic clutch adjustment. If yours doesn't have this feature, adjustment will have to be done by a trained certified mechanic. Have the adjustment done before clutch pedal free travel is reduced to the minimum allowable 1/2 in. (13 mm). Under normal wear conditions, the clutch will require periodic adjustment. See the clutch manufacturer's Service Manual for the proper adjustment procedures.

Specification Reference Charts

Pipe and Hose Clamp Torque Values

Torque specifications for engine parts.

Application	Type of Clamp	lb-in.	N•m
Radiator and Heat Exchanger Hoses	Constant Torque CT-L	90-110	10.2-12.5
Heater Hoses	Constant Tension	not required	not required
Air Intake Pipes	Hi Torque HTM-L	100-125	11.3-14.2
Plastic Air Intake Pipes	Constant Torque CT-L	88	10.0
Charge Air Intake Hoses	Flex Seal	70-100	7.9-11.3
	B9296	50-60	6-7

Application	Type of Clamp	lb-in.	N•m
Fuel, Oil and Water Heat Exchangers (for hoses less than 9/16 in. diameter).	Miniature 3600L	10-15	1.1-1.7

Wheel Cap Nut Torque Specifications

At the first scheduled lube interval, have all wheel cap nuts torqued to their specified

value. After that, check wheel cap nuts at least once a week. Contact an authorized dealer for information on the proper installation procedure for the wheels on your truck.

This is a job you may not be able to do yourself. You need the right torquing equipment to do it.

Wheel and Nut Configuration	Stud Size	Torque for Two Piece Flanged Cap Nuts	
		lb-ft	N•m
Hub-Piloted Disc-Type Wheel w/Two Piece Flanged Cap Nuts: Steel or Aluminum Wheel PHP-10; Budd Uni-Mount-10; WDH-8	M22-1.5	450-500	610-680
Stud Backnuts (when used)	3/4-16	175-200	240-270
	1-14	175-300	240-410
Cast Spoke Wheel Assembly Rim Clamp Nut Torque	1/2 in. Dia.	80-90	110-120
	5/8 in. Dia.	160-185	220-250
	3/4 in. Dia.	225-245	305-335

Lubrication Specification Chart

*Consult manufacturer or lubricant supplier for special details.

	<p>NOTE</p>
<p>The responsibility for meeting these specifications, the quality of the product, and its performance in service rests with the lubricant supplier.</p>	

Lubricant Symbol Key

5

Type	Application
ATF	MD3 or MERCON®-approved automatic transmission fluid
BB	High temperature ball bearing grease. Chevron SRI Mobile Grease HP, Texaco Multifax 2
CB	Engine oil for mild to moderate requirements
CC/CD	Engine oil for severe requirements (MIL-L-2104B /MIL-L-45199B) w/ 1.85 % max. sulfated ash
CD	Engine oil meeting API “Five engine test sequence”
CD50	SAE 50W synthetic transmission fluid
CE	Engine oil meeting severe duty service requirements for direct-injection turbocharged
CK-4/ CJ-4	Engine oil for PACCAR MX and Cummins EGR engines
CL	Multipurpose chassis grease

Type	Application
EP	Extreme Pressure Lubricant (Lithium 12-hydroxystearate base NLGI 2)
GL	Straight mineral gear lubricant
HD	Hypoid Gear Oil, A.P.I. - GL-5, SAE 75W-90FE synthetic gear lubricant
HT	High Temperature grease (Timken Spec. 0-616)
MP	Multipurpose gear lubricant (MIL-L-2105B)
DOT3	Brake Fluid

Component Lubrication Index

Application	Type
Steering Column	CL
Alternator Bearing	BB (1)
Fan Hub	BB (1)
Power Steering Reservoir	ATF
Steering Drag Link	CL
Steering Knuckles	CL
Spring Pins	CL

Application	Type
Clutch Release Bearings	BB
Brake Shoe Anchor Pins	HT
Brake Cam Bearings	HT
Slack Adjusters	CL
Starter Bearings	CC
Turbocharger Aneroid	CC
Water Pump	BB (1)
Suspension Fittings (other than threaded pins and bushings)	EP
Steering Axle: Grease Fittings on Steering Arm; Tie Rod Ends; Drag Link; King Pins	EP
Steering Shaft Grease Fittings	EP
Brake Treadle Hinge and Roller	Engine oil
Lock Cylinders	Lock lubricant
Door Hinges	Do not lubricate
Door Latches and Striker Plates	Polyethylene grease stick
Door Weatherstrip	Silicone lubricant

Application	Type
Hub-piloted Aluminum Wheels	Coat the wheel pilot or hub pads with Freylube #3 lubricant (light colored) or Chevron Zinc lube. Do not get lubricant on the face of the wheel or the hub.
Manual Transmission Hydraulic Clutch	DOT3 (Brake Fluid)
(1) Consult manufacturer or lubricant supplier for special details.	

Frame Fastener Torque Requirements

CAUTION

Incorrectly tightening the fasteners may result in failure of the fastener or incorrect clamp loads. Fastener failure may lead to frame failure. Failure to comply may result in equipment or property damage.

- Use a torque wrench for final tightening of these fasteners. Due to the coating on the threads of these bolts, be aware that if an impact gun is used to tighten the fasteners, they may over-torque and break.

- When torquing, the nut must rotate slightly before achieving the torque value. If the nut does not rotate, the fastener is over-torqued and should be replaced.
- To achieve correct clamp loads, the frame fasteners must be torqued with the nut. The intended clamp load may not be achieved if the nut is held and torque is applied to the bolt.

Where Nylon lock-nuts are indicated in the following tables,

- Use only ESNA Style Lock Nut, with nylon insert.
- Lubricate nylon insert nut lightly with SAE 20W or 30W oil.
- Tighten all frame fasteners with a torque wrench.



NOTE

The following values are applicable to fasteners on the FRAME and DO NOT APPLY to u-bolts for the suspension.

Fastener Size (-in.)	Tightening Specification lb-ft (N•m)
5/16	16-22 (22-30)
3/8	30-40 (41-54)
7/16	55-65 (75-88)
1/2	80-90 (109-122)
9/16	115-140 (156-190)
5/8	165-195 (224-265)

Fastener Size (-in.)	Tightening Specification lb-ft (N•m)
3/4	290-340 (394-462)
7/8	380-460 (517-626)
1	700-830 (952-1,129)
1-1/8	990-1,170 (1,346-1,591)
1-1/4	1,380-1,630 (1,877-2,217)

Metric Fastener Size (with NYLON insert nuts)	Tightening Specification lb-ft (N•m)
M5	6-9 (8-12)
M6	7-11 (9-15)
M8	17-23 (23-31)

Where fasteners with all-metal lock-nuts are indicated in the following table

- Do not lubricate these fasteners.

- Bolts and washers can be reused, but nuts can only be reused once. If in doubt, install new nuts.
- If a bolt must be replaced, then nuts and bolts must be replaced in pairs.
- Fasteners must be torqued from the nut to achieve correct clamp load.

Metric Fastener Size (with all METAL Lock-nuts)	Tightening Specification lb-ft (N•m)
M10	29-41 (39.4-55.6)
M12	51-69 (69.1-93.5)
M16	125-165 (169.5-223.7)
M20	230-300 (311.8-406.8)

Suspension U-Bolts, Grade 8

Tighten all U-bolts with a torque wrench. Torque requirements in the table below

apply to PACCAR proprietary suspensions using Protec Torque/TEXO coated U-bolts, only. For all other suspensions, follow the manufacturer's recommended torque values. PACCAR proprietary suspension u-bolts must be tightened in a specific sequence. Take your vehicle to an authorized dealer to tighten the U-bolts on your vehicle.

Torque for Grade 8 U-Bolts

Peterbilt Front Suspension U-bolts		
U-Bolt Size Diameter (-in.)	Torque (lb-ft)	Torque (N•m)
3/4	260-290	353-393
7/8	370-415	502-563
For all non-PACCAR suspension systems, see the manufacturer's operator's manual for torque specifications.		

Peterbilt Rear Suspension U-bolts		
Rear Suspension Type	U-Bolt Diameter	Torque lb-ft (N•m) ²⁴
Low Air Leaf (U-bolt, spring)	M22 x 1.5	375–475 (508–644)
Flex Air	M22 x 1.5	325–375 (440–508)
Tandem Low Air Leaf	M22 x 1.5	375–475 (508–644)
Air Leaf (U-bolt, spring)	1.0 -in. NF	450–550 (610–746)
Air-Trac	1.0 -in. NF	450–550 (610–746)
13.5K Taper Leaf (Axle U-bolt)	¾ -in. 16 UNF	275–320 (373–434)

Peterbilt Rear Suspension U-bolts		
Rear Suspension Type	U-Bolt Diameter	Torque lb-ft (N•m)
18K Taper Leaf (Axle U-bolt)	¾ -in. 16 UNF	275–320 (373–434)
18K Air Leaf (Axle U-bolt)	¾ -in. 16 UNF	275–320 (373–434)
For all non-PACCAR suspension systems, see the manufacturer's operator's manual for torque specifications.		

	NOTE
The values shown here are for suspension U-bolts and should not be applied to bolts and fasteners for the frame.	

Low Air Leaf Torque Values

Low Air Leaf Torque values apply to both single and tandem axles.

Fastener	Fastener Name	Torque lb•ft (N•m)
M20 x 2.5	Bar pin bolts	325–425 (441–576)
M22 x 1.5	U-bolt, spring ²⁵	Refer to section on Suspension U-Bolts, Grade 8.
0.5 UNC	Air bag stud nut	40–50 (54–68)
M16	Tracking rod bolts	155–195 (210–264)

²⁴

Torques listed are for primed (or non-oiled) U-bolts.

²⁵ Contact your dealer for torque tightening procedure.

Flex Air Fastener Torque Values

Fastener	Fastener Name	Torque lb-ft (N•m)
M16	Drive bracket - frame bolts	155–195 (210–264)
	Drive bracket - link spring bolt	
	Drive bracket - radius rod bolt	
	Drive beam - shock bolt (lower)	
	Shock bracket -	

Fastener	Fastener Name	Torque lb-ft (N•m)
	shock bolt (upper)	
	Tracking rod bolts (all)	
M10	Air spring support beam bolts	36–51 (49–69)
0.88 - 14 UNF	Drive beam - link spring bolt	380–460 (515–624)
0.88 - 14 UNF	Radius rod bracket bolt	380–460 (515–624)
M22 x 1.5	U-bolt ²⁶	Refer to section on Suspension U-Bolts, Grade 8.

Fastener	Fastener Name	Torque lb-ft (N•m)
0.5 UNC	Air bag stud nut	40–50 (54–68)

Air Leaf Fastener Torque Values

Fastener	Fastener Name	Torque lb-ft (N•m)
1 NF x 8.5"	Spring eye bolt	225–550 (305–746)
0.75 NC x 2.25"	Alignment cap screw	208–296 (282–401)
0.75 NF	Spring eye U-bolt (rolled threads)	50–100 (68–136)

²⁶ Contact your dealer for torque tightening procedure.

Fastener	Fastener Name	Torque lb-ft (N•m)
0.75 NC x 5.0"	Spring eye clamp bolt	165–210 (68–136)
0.75 NF	Spring center bolt	165–210 (224–285) ²⁷
1 NF	U-bolt, spring ²⁸	Refer to section on Suspension U-Bolts, Grade 8.
0.5 UNC	Air bag stud nut	40–50 (54–68)
M16	Tracking rod bolts	155–195 (210–264)

Air-Trac Fastener Torque Values

Fastener	Fastener Name	lb•ft (N•m)
M16	Tracking rod bolts	155–195 (210–264)
0.75 NF	Spring center bolt	165–210 (224–285) ²⁹
M16 0.75 NF	Radius rod bolts (forward)	155–195 (210–264)
	Radius rod bolts (at axle)	250–350 (339–475)
M16	Frame bracket bushing bolts	50–65 (68–88)

Fastener	Fastener Name	lb•ft (N•m)
1.0 NF	U-bolt ³⁰	Refer to section on Suspension U-Bolts, Grade 8.
0.5 UNC	Air bag stud nut	40–50 (54–68)
M16	Tracking rod bolts	155–195 (210–264)

Noise Control System - Maintenance Log

To ensure your vehicle's noise control requirements are maintained, record maintenance checks. Use the following log sheet and retain copies of documents

²⁷ Torque requirement applies at subassembly of air spring support and leaf spring only.

²⁸ PACCAR proprietary suspension U-bolts must be tightened in a specific sequence. Take your vehicle to an authorized dealer to tighten the U-bolts on your vehicle.

²⁹ Torque requirement applies at subassembly of airspring support and leaf spring only.

³⁰ See owners manual for torque tightening sequence.

regarding maintenance services performed and parts replaced on the vehicle.

Component	Recommended Interval (Miles)	Date & R.O. No.	Repair Facility & Location	Work Performed	Date & R.O. No.	Repair Facility & Location	Work Performed
Exhaust System Routing Integrity	25,000						
Shutters Shrouds	25,000						
Hood Insulation Blanket	10,000						
Engine Mounted Hose Insulators Fasteners	10,000						
Inner Fender Shields	50,000						
Cab Skirts Fasteners	50,000						
Air Intake System Integrity Element	5,000						
Clutch-type Fan Drive	10,000						

Chapter 6 | INFORMATION

Consumer Information.....	287
Vehicle Identification Labels.....	287
Clean Idle.....	290
Greenhouse Gas Certified Configuration.....	291
Vehicle Emissions Limited Express Warranty.....	294

Consumer Information

How to Order Replacement Parts

Replacement parts may be obtained from an authorized dealership. When you order, it is **IMPORTANT** that you have the following information ready:

- Your name and address
- Serial number of the truck
- The name of the part you need
- The name and number of the component for which the part is required
- The quantity of parts you need
- How you want your order shipped

National Highway Traffic and Safety Administration (NHTSA)

If you believe that your vehicle has a defect, which could cause a crash or could cause death or personal injury, you should immediately inform the National Highway Traffic Safety Administration (NHTSA) in addition to notifying the vehicle manufacturer. If NHTSA receives similar complaints, it may open an investigation, and if it finds that a safety defect exists in a group of vehicles, it may order a recall and

remedy campaign. However, NHTSA cannot get involved in individual problems between you, your dealer, and vehicle manufacturer. Contacting NHTSA is possible through telephone, written mail and email. NHTSA also has a website where you can input your comments directly to them on the web. Please use any of the four ways to contact NHTSA:

Toll Free 1-888-327-4236 (800-424-9153
TTY) 8:00 a.m. to 10:00 p.m. EST
Monday-Friday

Office of Defects Investigations/CRD
NV5-216 1200 New Jersey Ave. SE
Washington, D.C. 20590

www.safercar.gov

email: nhtsa.webmaster@dot.gov

Transport Canada

Canadian customers who wish to report a safety-related defect to Transport Canada, Defect Investigations and Recalls, may telephone the toll free hotline 1-800-333-0510, or contact Transport Canada by mail at:

Transport Canada, ASFAD Place de Ville
Tower C 330 Sparks St. Ottawa, ON K1A
0N5

For additional road safety information,
please visit the Road Safety website at:
<http://www.tc.gc.ca>

Vehicle Identification Labels

Each vehicle completed by Peterbilt Motors Company uses a vehicle identification number (VIN) that contains the model year designation of your vehicle. The practice is in compliance with 49 CFR 565, Code of Federal Regulations.

The full, 17-digit VIN is located on the Weight Rating Data Label. The label is located on the driver's side door edge or on the driver's side door frame.

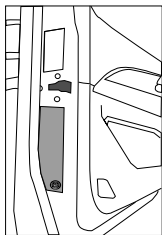
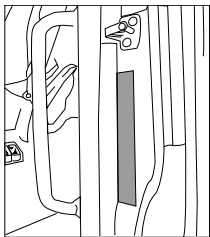

- Back of cab, left-hand rear panel, lower edge
- Tire, Rim, and Weight Rating Data label (truck)
- Components and Weights label
- Noise Emission label
- Paint Identification label

Certification Labels

Your vehicle information and specifications are documented on labels. As noted below, each label contains specific information pertaining to vehicle capacities and specifications that you should be aware of.

Components and Chassis Weight Label

The Components and Chassis Weight Label is located on either the driver's side door edge or on the driver's side door frame. It includes chassis number, chassis weight and gross weight, plus model information for the vehicle, engine, transmission, and axles.

Tire, Rim and Weight Rating Data Label

The Tire, Rim, and Weight Rating Data Label is located on the driver's side door

edge or on the driver's side door frame. It contains the following information:

- GVWR - Gross Vehicle Weight Rating
- GAWR FRONT, INTERMEDIATE and REAR - Gross Axle Weight Ratings for Front, Intermediate and Rear Axle
- TIRE/RIM SIZES AND INFLATION PRESSURES - Tire/Rim Sizes and Cold Pressure Minimums
- VIN including CHASSIS NUMBER.

The components of your vehicle are designed to provide satisfactory service, if the vehicle is not loaded in excess of either the gross vehicle weight rating (GVWR), or the maximum front and rear gross axle weight ratings (GAWRs).



WARNING

DO NOT exceed the specified load rating. Overloading can result in loss of vehicle control, either by causing component failures or by affecting vehicle handling. Exceeding load ratings can also shorten the service life of the vehicle. Failure to comply may result in death or personal injury.

Chassis Number

The Chassis Number refers to the last six characters of the VIN. This number will allow your dealer to identify your vehicle. You will be asked for this number when you bring it in for service. Chassis Number Locations

- Right frame rail, top flange, about 3 ft. from the front end

 NOTE
<p>GVW is the TOTAL SCALE WEIGHT the vehicle is designed to carry. This includes the weight of the empty vehicle, loading platform, occupants, fuel, and any load.</p>

Noise Emission Label

The Noise Emission Label is located in the driver's side door frame. It contains information regarding U.S. noise emission regulations, chassis number, and date of manufacture.

Paint Identification Label

The Paint Identification Label contains the paint colors used by the factory to paint your vehicle. It lists frame, wheels, cab interior and exterior colors. This label is located inside the glove box.

Federal Safety Standard Certification Label

The NHTSA regulations require a label certifying compliance with Federal Safety Standards, for United States and U.S. Territories, be affixed to each motor vehicle and prescribe where such label may be located. This certification label, which

indicates the date of manufacture and other pertinent information, is located on the driver's side door edge or on the driver's side door frame.

Component Identification

Each of the major components on your vehicle has an identification label or tag. For easy reference, record component numbers such as, model, serial, and assembly number.

Engine	For further information, please refer to the Engine Operation and Maintenance Manual.
Transmission	For both manual and automatic transmissions, the identification number is stamped on a tag affixed to the right rear side of the transmission case.
Clutch	Enclosed in clutch housing. Location depends on manufacturer.
Steer Axle	The front axle serial number is stamped on a plate located on the center of the axle beam.
Axle Specification Number	Usually stamped on the right rear side of the axle housing. This number identifies the complete axle.
Axle Housing Number	Usually located on the left forward side of the housing arm. This tag identifies the axle housing.

Axle Differential Carrier Identification	Usually located on the top side of the differential carrier. The following information is either stamped, or marked with a metal tag: Model No., Production Assembly No., Serial No., Gear Ratio, and Part Number.
--	--

Clean Idle

To comply with CARB emissions requirements, your vehicle will either have the Certified Clean Idle label or an Engine Shutdown System (ESS). Some vehicles, however, are exempt from these requirements because of their configurations (for example: fire truck service).

Your vehicle may have either of these labels affixed to the vehicle to identify that its engine meets the strict low exhaust emission regulations instituted by the state of California (and other states that have chosen to adopt CARB emissions requirements). Trucks with this type of engine will not require an Engine Shutdown System and will be allowed to idle continuously. It is important that you do not remove or deface this label. Do not block it from view. Please contact your authorized dealership if you need to replace this label. The dealership will be

able to help you to determine whether or not your vehicle's engine may be a candidate for a Certified Clean Idle label if it did not already have the label. If you have a PACCAR PX-7 or PX-9 engine, your label will look like the image below.



If you have a Cummins engine, your label will look like the image below.



Engine Shutdown System

If the vehicle's engine does not meet the low exhaust emission standard it will have an Engine Shutdown System (ESS) to meet limited idle regulations implemented by CARB and some additional states. These regulations require that the engine have an automatic system to restrict the idle time on certain vehicles. An Engine Shutdown System will shut down the engine after 5 minutes if the vehicle idles with the park brake set and the transmission in 'neutral' or 'park'. The ESS will also allow the vehicle 15 minutes of idle time if the driver does not set the park brake and shifts the transmission to 'neutral' or 'park'. The ESS, however, will not shut down the engine if the engine is operating in Power Take Off (PTO) mode, if the engine coolant is below 60 degrees Fahrenheit, or if the engine is performing a parked regeneration. The check engine light will alert you when the ESS shutdown timer reaches the last 30 seconds before the engine shuts down. The last 30 seconds prior to engine shutdown is the

only time the driver may reset the idle time by pressing on the accelerator. More detailed information may be available in the Engine Operator's Manual provided with your vehicle.

ject to fines and penalties. Please contact the vehicle manufacturer for further information about this vehicle's certified configuration.

regulatory subcategory

Greenhouse Gas Certified Configuration

This vehicle includes Greenhouse Gas (GHG) regulated parameters and technologies. A Vehicle Emission Control Information label is located on the driver's door with codes that partially identify the vehicle's GHG certified configuration. In addition to the Vehicle Emission Control Information label, other technologies that reduce GHG emissions and regulated parameters included in the vehicle's GHG certified configuration are described in this section.

	NOTE
Modifying a vehicle's certified configuration without good engineering judgment or PACCAR's approval may be a violation of the Clean Air Act and sub-	

Vehicle Emission Control Information Label Descriptions

Label Identifiers	Label Identifier Descriptions
Family Name	Describes the vehicle's certified manufacturer, regulatory category, and regulatory subcategory
Emission Controls	Describes regulated emission control devices installed on the vehicle
Compliance Statement	Describes the vehicle's compliance standards
Regulatory Subcategory	Describes the vehicle's certified

Emission Controls	Emission Control Descriptions
ARF	Aerodynamic roof fairing
ARFR	Adjustable height aerodynamic roof fairing
ATS	Aerodynamic side skirt and/or fuel tank fairing
AFF	Aerodynamic front fairing
AREF	Aerodynamic rear fairing
TGR	Gap reducing fairing
LRRA	Low rolling resistance tires (all)

LRRD	Low rolling resistance tires (drive)
LRRS	Low rolling resistance tires (steer)
VSL	Vehicle speed limiter
VSLS	Soft-top vehicle speed limiter
VSLE	Expiring vehicle speed limiter
VSLD	Vehicle speed limiter with both soft-top and expiration
IRT	Engine shutoff system
IRT5	Engine shutoff after 5 minutes or less of idling
IRTE	Expiring engine shutoff
ADVH	Vehicle includes advanced hybrid

	technology components
ADVO	Vehicle includes other advanced-technology components
INV	Vehicle includes innovative (off-cycle) technology
ATI	Automatic tire inflation system
TPMS	Tire pressure monitoring system

GHG Regulated Technology Not On the Emission Control Information Label

Technology	Compliance Requirements
Wheel-Related Weight Reduction	Wheel-related weight reduction benefits may be included in this vehicles certified

	configuration. Changing aluminum wheels to a steel wheels may be a violation of the Clean Air Act and subject to fines and penalties.
Nonwheel-Related Weight Reduction	Nonwheel-related weight reduction benefits may be included in this vehicles certified configuration. Changing aluminum material to steel material may be a violation of the Clean Air Act and subject to fines and penalties.

Idle Reduction This vehicle may be equipped with factory installed automatic engine shutdown (AES), neutral idle, start-stop systems, intelligent controls (Predictive Cruise Control and Neutral Coast), or extended idle reduction systems (Engine Idle Shutdown Timer, Engine Auto Start, Kenworth Idle Management System <<<KW book only>>>, SmartAir <<<PB book only>>>, Fuel-Fire Sleeper Heater System). Disabling or modifying any idle reduction system may be a violation of the Clean Air Act and

subject to fines and penalties.

GHG Regulated Powertrain Parameters Not On the Emission Control Information Label

Powertrain Components	Regulated Parameters
Engine	Engine idle speed, torque, horsepower, and governed RPM
Transmission	Lock up gear, number of gears, and torque converter
Axle	Configuration and drive axle ratio

GHG Regulated Aerodynamic Performance

The vehicle needs to stay in as-built aerodynamic performance unless good engineering judgment shows that the

modification will improve safety or will not increase greenhouse gases.

GHG Regulated Air Conditioning Leakage Standards

Loss of refrigerant from the air conditioning systems may not exceed a total leakage rate of 11.0 grams per year or a percent leakage rate of 1.50 percent per year, whichever is greater. This vehicle was built to meet this air conditioning leakage standards. Any modification of the air conditioning system must comply with leakage rates defined in SAE J2727.

i	NOTE
<p>Modifying a vehicle's certified configuration without good engineering judgment or PACCAR's approval may be a violation of the Clean Air Act and subject to fines and penalties. Please contact the vehicle manufacturer for further information about this vehicle's certified configuration.</p>	

Vehicle Emissions Limited Express Warranty

Original Equipment Tires

PACCAR Inc. warrants the tires installed as original equipment on this vehicle only against defects in materials and workmanship which cause the vehicle to fail to comply with applicable U.S. and Canadian greenhouse gas emission limits ("Warrantable Emissions Failures"). This vehicle emissions limited express warranty relating to original equipment tires is valid for two (2) years or 24,000 miles (38,000 km), whichever occurs first. YOUR SOLE AND EXCLUSIVE REMEDY AGAINST PACCAR Inc. IS LIMITED TO THE REPAIR OR REPLACEMENT OF ORIGINAL EQUIPMENT TIRES, SUBJECT TO PACCAR'S TIME AND MILEAGE LIMITATIONS LISTED ABOVE. This Vehicle Emissions Limited Express Warranty relating to original equipment tires begins on the date of delivery of the vehicle to the first purchaser or lessee and accrued time and mileage is calculated when the vehicle is brought in for correction of the Warrantable Emissions Failures relating to the original equipment

tires. PACCAR MAKES NO OTHER VEHICLE EMISSIONS WARRANTIES RELATING TO THE ORIGINAL EQUIPMENT TIRES, EXPRESS OR IMPLIED. WHERE PERMITTED BY LAW, PACCAR EXPRESSLY DISCLAIMS ANY WARRANTY OF MERCHANTABILITY OR FITNESS FOR A PARTICULAR PURPOSE RELATING TO VEHICLE EMISSIONS. PACCAR AND THE SELLING DEALER SHALL NOT BE LIABLE FOR INCIDENTAL OR CONSEQUENTIAL DAMAGES INCLUDING, BUT NOT LIMITED TO: LOSS OF INCOME OR LOST PROFITS; VEHICLE DOWNTIME; COMMUNICATION EXPENSES; LODGING AND/OR MEAL EXPENSES; FINES; APPLICABLE TAXES OR BUSINESS COSTS OR LOSSES; ATTORNEY'S FEES; AND ANY LIABILITY YOU MAY HAVE IN RESPECT TO ANY OTHER PERSON OR ENTITY RELATING TO WARRANTABLE EMISSIONS FAILURES. This Vehicle Emissions Limited Express Warranty relating to original equipment tires is limited to emissions compliance only. The tires are separately warranted by their manufacturer for defects in materials and workmanship other than those which cause non-compliance with

U.S. and Canadian GHG regulations, subject to limitations and conditions contained within the tire manufacturer's warranty agreement. You are responsible for the safe operation and maintenance of the vehicle and its tires. PACCAR does not warrant wear and tear of the tires.

Greenhouse Gas (GHG) Components Other Than Tires

This GHG vehicle Warranty applies to the vehicle (hereafter, vehicle) certified with the US Environmental Protection Agency.

Your Warranty Rights and Obligations

This vehicle is warranted for components that directly impact the manufacturers GHG certification with the US Environmental Protection Agency. PACCAR must warrant these components for the periods of time listed below provided there has been no abuse, neglect or improper maintenance of the vehicle. If a GHG-related part on your vehicle is found to have a defect in material or assembly, the part will be repaired or replaced by PACCAR.

Manufacturer's Warranty Coverage

This warranty coverage is provided for five years or 100,000 miles (160,000 km), whichever occurs first, from the date of delivery of the vehicle to the first purchaser or first lessee. Where a Warrantable Condition exists, PACCAR will diagnose and repair the vehicle, parts and labor included, at no cost to the first purchaser or first lessee and each subsequent purchaser or lessee. This warranty does not override any extended warranty purchased to cover specific vehicle components.

Owner's Warranty Responsibilities

The vehicle owner is responsible for performing required maintenance that is listed in your engine and vehicle Operator's Manuals. The owner is responsible for presenting the vehicle to a service location as soon as a problem exists. Any warranty repairs should be completed in a reasonable amount of time. Retain all receipts covering maintenance on this equipment. PACCAR cannot deny warranty solely for the lack of receipts or for the failure to ensure the performance of all scheduled maintenance. PACCAR may deny warranty coverage if a vehicle

component has failed due to abuse, neglect, improper maintenance, unapproved modifications (both physical components and computer programming) or using non-Original Equipment replacement parts. If there are any questions regarding these warranty rights and responsibilities, please contact the vehicle OEM manufacturer at the customer center telephone number provided with the vehicle operating instructions. Prior to the expiration of the applicable warranty, Owner must give notice of any warranted failure to an authorized PACCAR dealer and deliver the vehicle to such facility for repair. Owner is responsible for incidental costs such as: communication expenses, meals, lodging incurred by Owner or employees of Owner as a result of a Warrantable Condition. Owner is responsible for downtime expenses, cargo damage, fines, all applicable taxes, all business costs, and other losses resulting from a Warrantable Condition. Owner is responsible for maintaining all emissions related engine and vehicle computer program settings in accordance with manufacturer specifications. This responsibility includes GHG specific settings that may not be altered before the GHG-related expiration mileage has been

reached for each system. Owner is responsible for maintaining all physical parts related to GHG-regulations in the as-built configuration and in proper working order for the full regulatory useful life of 435,000 miles (700,000 km) or 10 years for Class 8 vehicles, 185,000 miles (300,000 km) or 10 years for Class 5-7.

Replacement Parts

PACCAR recommends that any service parts used for maintenance, repair or replacement of GHG components be new or genuine approved rebuilt parts and assemblies. The use of non-genuine engine or vehicle replacement parts that are not equivalent to the PACCAR engine or OEM vehicle manufacturer's original part specification as built from the factory may impair the engine and vehicle emissions control system from working or functioning effectively, and may jeopardize your GHG warranty coverage. In addition, genuine vehicle or engine parts must be replaced with the same material and function as the part assembled on the vehicle from the factory. The owner may elect to have maintenance, replacement or repair of the emission control parts performed by a facility other than an authorized PACCAR dealer and may elect

to use parts other than new or genuine approved rebuilt parts and assemblies for such maintenance, replacement or repair; however, the cost of such service or parts and subsequent failures resulting from such service or parts may not be fully warranted if the manufacturer determines that the replacement part is not of similar material and function as the OEM part assembled to the vehicle at the factory.

PACCAR Responsibilities

The warranty coverage begins when the vehicle is delivered to the first purchaser or first lessee. Repairs and service performed by any authorized PACCAR dealer using new or genuine approved rebuilt parts and assemblies will utilize replacement parts that are selected and installed to support the GHG compliance certification. PACCAR will repair parts found by PACCAR to be defective without charge for parts or labor (including diagnosis which results in determination that there has been a failure of a warranted part).

Warranty Limitations

Sole and exclusive remedy against PACCAR and the Selling Dealer arising from the purchase and use of this vehicle is limited to the repair or replacement of

"warrantable failures", for replacement parts that are similar in material and function to OEM specifications and subject to PACCAR's time, mileage, and hour limitations of the greenhouse gas warranty. The maximum time, mileage and hour limitations of the warranty begin with the Date of Delivery to the first purchaser or first lessee. The accrued time, mileage, or hours is calculated when the vehicle is brought in for correction of warrantable failures. PACCAR is not responsible for failures or damage resulting from what PACCAR determines to be abuse, neglect or uncontrollable acts of nature, including, but not limited to: damage due to accident; operation without adequate coolants or lubricants; overfueling; overspeeding; lack of maintenance of cooling, lubricating or intake systems; improper storage, starting, warm-up, run-in or shutdown practices; unauthorized modifications to the vehicle and its components. PACCAR is also not responsible for failures caused by incorrect oil, fuel or diesel exhaust fluid or by water, dirt or other contaminants in the fuel, oil or diesel exhaust fluid. Failure of replacement parts used in repairs due to the above non-warrantable conditions is not warrantable. This warranty is void if the vehicle is altered with parts that do not meet the

material and functional specifications as manufactured from the factory. Any alterations to vehicle or engine computer settings will void GHG warranty and potentially cause the vehicle to become non-compliant with EPA Clean Air Act GHG regulations. Any alterations to GHG specific settings prior to the GHG related expiration mileage for each system will void GHG warranty and potentially cause the vehicle to become non-compliant with EPA Clean Air Act GHG regulations. This warranty is void if certain GHG components are not properly maintained and thus cannot perform to their designed capability. PACCAR is not responsible for failures resulting from improper repair or the use of parts which are not genuine approved parts. PACCAR is not responsible for the material and labor costs of emission control parts and assemblies replaced during Scheduled Maintenance of the engine as specified in PACCAR Operator's Manuals. THIS WARRANTY, TOGETHER WITH THE EXPRESS COMMERCIAL WARRANTIES ARE THE SOLE WARRANTIES MADE BY PACCAR IN REGARD TO THIS VEHICLE. THIS LIMITED GHG WARRANTY IS THE SOLE WARRANTY MADE BY PACCAR AND THE SELLING DEALER. EXCEPT FOR

THE ABOVE LIMITED WARRANTY, PACCAR AND THE SELLING DEALER MAKE NO OTHER WARRANTIES, EXPRESS OR IMPLIED. PACCAR AND THE SELLING DEALER EXPRESSLY DISCLAIM ANY WARRANTY OF MERCHANTABILITY OR WARRANTY OF FITNESS FOR A PARTICULAR PURPOSE. PACCAR AND THE SELLING DEALER SHALL NOT BE LIABLE FOR INCIDENTAL OR CONSEQUENTIAL DAMAGES INCLUDING, BUT NOT LIMITED TO: LOSS OF INCOME OR LOST PROFITS; ENGINE OR VEHICLE DOWNTIME; THIRD PARTY DAMAGE, INCLUDING DAMAGE OR LOSS TO OTHER ENGINES, VEHICLES OR PROPERTY, ATTACHMENTS, TRAILERS AND CARGO; LOSS OR DAMAGE TO PERSONAL CONTENTS; COMMUNICATION EXPENSES; LODGING AND/OR MEAL EXPENSES; FINES; APPLICABLE TAXES OR BUSINESS COSTS OR LOSSES; ATTORNEYS' FEES; AND ANY LIABILITY YOU MAY HAVE IN RESPECT TO ANY OTHER PERSON OR ENTITY.

Index

A

Active Cruise Control Set Following Distance [127](#)
Active Warnings [56, 73](#)
adaptive cruise control [121](#)
Adaptive Cruise Control [126](#)
Adaptive Cruise Control Notification, *See* ADAS Notification
ADAS Notification [60](#)
Adding Coolant [228](#)
Additives to Cooling System [224](#)
Adjust Side Mirrors [97](#)
Advanced ABS with Stability Control [139](#)
Aiming Headlamps [235](#)
Air Cleaners [247](#)
Air Conditioner [104](#)
Air Conditioner Control Panel [105](#)
Air Conditioner Sleeper [109](#)
Air Disc Brakes [218](#)
Air Dryer Maintenance [212](#)
Air Filter [247](#)
Air Gauges and Air Leaks [214](#)
Air Intake System [246](#)
Air Leaf Fastener Torque ValueRear Suspension Fasteners [282](#)
Air Ride Height Data [152](#)
Air Tanks [214](#)
Air-Controlled Sliding Fifth Wheel [157](#)
Air-Operated Kingpin Release, *See* How to Release the Kingpin from the Cab
Air-Trac Fastener Torque ValueRear Suspension Fasteners [283](#)
Alarm ClockSet alarm [110](#)
Alarm ClockSet time [110](#)
Altering the Electrical System [236](#)
Alternator [241](#)
Anti-Theft [68, 117](#)
Antilock Brake System [77](#)
Applies To [6](#)

At first 15,000 mi / 24,000 km or at first PM [173](#)
Auto Slack Adjuster [218](#)
Automatic Slack Adjuster Stroke Specification [219](#)
Automatic time [64](#)
Automatic Traction Control [140](#)
Axle Temperature Gauge [84](#)
Axle, Traction Control [76, 77, 137](#)
See also ATC
AxleAuxiliary [148](#)
AxleDiff Lock [146](#)
AxleDifferential Lock [146](#)
AxleDual Range [146](#)
AxlePusher Tag [148](#)
AxleTwo Speed [146](#)

B

Back Button [55](#)
Basic View [61](#)
Batteries [237](#)
Battery Voltage [58](#)
Battery, Jump Start [38](#)
Belt
 Komfort Latch [23](#)
 Lap/Shoulder [22](#)
 Safety [19](#)
 Tether [22](#)
Bendix® AD-HF Series Air Dryer [213](#)
Brake System [217](#)
Brake, Park Brake [78](#)
Brake, ParkingManual release [41](#)
Brakes, Antilock Brake System [77](#)
Brakes, Low Air [78](#)
Brakes, Trailer Antilock Brake System [78](#)

Bulb Check [71](#)

C

Cab

How to Lock and Unlock the Doors [14](#)

Cab Access [13](#)

Cab Accessories [110](#)

Cab Maintenance [219](#)

Cab Structure, Doors and Hoods [224](#)

CAN bus [236](#)

Care of Display Screens on the Dashboard [224](#)

Check Engine Oil Level [243](#)

Cleaning LCD Display Screens [224](#)

Climbing onto the Deck Plate [15](#)

Clock [58, 64](#)

Close the Hood [18](#)

Clutch [273](#)

Clutch Linkage [273](#)

Clutch Pedal [273](#)

Coolant fill [228](#)

Coolant level [228](#)

Coolant Level [227](#)

Cooling system maintenance [224](#)

Cooling System Overheating [34](#)

Cranking Battery Specification [239](#)

cruise control [121](#)

Cruise Control [124](#)

Cruise ControlCancel [125](#)

Cruise ControlChange Set Speed [125](#)

Cruise ControlResume Set Speed [125](#)

Cruise ControlSet Speed [124](#)

Cruise ControlStandard [123](#)

D

Daily Checks [28](#)

Dash Switch Tailer Hand Brake [137](#)

Dashboard Display Screen [224](#)

Dedicated Telltales [72](#)

Deep Snow and Mud Switch [141](#)

Diesel Exhaust Fluid (DEF) [62](#)

Diesel Exhaust Fluid tank maintenance [259](#)

Diesel Particulate Filter (DPF) Warning Light [79](#)

Diesel Particulate Filter Status [57](#)

Differential, Inter-Axle Lock [79](#)

Digital Display [68](#)

Digital Gauges [62](#)

Display [68](#)

Display Launch [55](#)

DNR [57](#)

Door Mounted Mirror Controls [97](#)

DPA, See Driver Performance Assistant

DPF Status [57](#)

DR, See Driver Rewards

Draining the Primary Fuel Filter [249](#)

Drive Axle - Dana [262](#)

Drive Axle - Meritor [262](#)

Drive Axle SISU [264](#)

Drive Axle Temperature Gauge [84](#)

Drum Brake Inspection [219](#)

Dual Air System Function Test [212](#)

Dual Range (Two-Speed) Rear Axle [146](#)

Dump Truck, Body Up [79](#)

Dump Truck, Gate [79](#)

Dynamic Telltale [73](#)

E

Eaton/Dana Axle Lubrication [262](#)

Effectiveness and Limitations [142](#)

Electric Steer Assist [128](#)

Electrical System [233](#)

ELST [103](#)

Emissions [154](#)

Emissions Engine Derate [81](#)

Emissions, High Exhaust System Temperature [79](#)

Emissions, Malfunction Indicator Lamp [80](#)

Index

Engine Aftertreatment System [154](#)
Engine Brake [99](#)
Engine Brake Column Mounted Transmission Control [121](#)
Engine Brake indicator [121](#)
Engine Brake PACCAR Transmission [121](#)
Engine Cooling Recommendations and Specifications [224](#)
Engine Fan [245](#)
Engine Hours [58](#)
Engine is overheating [34](#)
Engine Maintenance [243](#)
Engine Mounting [248](#)
Engine Wait-To-Start Lamp [81](#)
Engine Warm Up [118](#)
Engine, Check Engine [80](#)
Engine, Engine Block Heater [80](#)
Engine, Low Coolant Level [80](#)
Engine, Overspeed Air Shutdown [80](#)
Engine, Retarder (Brake) [80](#)
Engine, Stop Engine [81](#)
Enhanced View [61](#)
Every 120,000 mi / 192,000 km / Annually [200](#)
Every 15,000 mi / 24,000 km / Monthly [180](#)
Every 240,000 mi / 384,000 km [205](#)
Every 25,000 mi / 40,000 km / 6 Months [186](#)
Every 30,000 mi / 48,000 km [187](#)
Every 300,000 mi / 480,000 km / 6,750 Hours / 3 Years [206](#)
Every 500,000 mi / 800,000 km / 5 years [207](#)
Every 60,000 mi / 96,000 km / 6 Months [190](#)
Every 750,000 mi / 1,200,000 km / 24,000 Hours / 8 years [207](#)
Exhaust [154](#)
Exhaust System [248](#)
Extended Life Coolant [229](#)
Exterior Lamp Self Test Switch [103](#)
Exterior Lamps Self Test [103](#)
Exterior Lights Self Test [103](#)

F

Fast Idle Control [82](#)
Favorites View [63](#)

Fifth Wheel [154](#), [156](#)
Fifth Wheel Bi-Annual Maintenance [251](#)
Fifth Wheel Locked Indicator/Fifth Wheel [82](#)
Fifth Wheel Monthly Maintenance [251](#)
Fifth Wheel Slide, See How to Slide the Fifth Wheel
Fifth Wheel Slide Switch [91](#)
Fifth Wheel Slide Unlocked [81](#)
Fifth Wheel Unlocked Indicator/Fifth Wheel [82](#)
Final Chassis Bill of Material [13](#)
Final Stopping Procedures [163](#)
Flashing Headlamps, Aftertreatment Warning [154](#)
Flex Air Fastener Torque Value/Rear Suspension Fasteners [282](#)
Frame [250](#)
Frame Fastener Torque Requirements [279](#)
Free Travel [273](#)
Front axle and Suspension [252](#)
Front Suspension U-Bolts, Grade 8 [280](#)
Fuel Level [62](#)
Fuel System [248](#)
Fuel Tank [250](#)
Fuller Transmission Lubrication [272](#)
Fuse box label [236](#)
FuseInspect and replace [36](#)
FuseLocation [37](#)
Fuses, Circuit Breakers and Relays [236](#)

G

General Safety Instructions [8](#)
Greenhouse Gas Certified Configuration [291](#)
Greenhouse Gas Certified Tires [271](#)

H

Hand Brake Trailer [137](#)
Headlight [93](#)
Heater and Air Conditioner Maintenance [255](#)
High Beam [100](#)
High Beam Flash [100](#)

Horn honking, Aftertreatment Warning [154](#)
How to Add Coolant to the Cooling System [228](#)
How to Adjust Mirrors [97](#)
How to Change the Headlight Bulb [235](#)
How to Check the Compressed Air System for Leaks [215](#)
How to inspect brake pads on disc brakes [218](#)
How to Manually Control the Air Conditioner for the Cab [107](#)
How to open the hood [17](#)
How to Prepare the Axles for Towing [44](#)
How to Recover a Vehicle Towing [40](#)
How to Replace Air Conditioner Filter [256](#)
How to Use the ELST Switch [103](#)
How to Wash the Exterior of the Vehicle [222](#)

I

Ice [48](#)
Illustrations [8](#)
In Cab Battery Access [239](#)
Inspect Disc Brake Caliper for Running Clearance [218](#)
Inspecting Noise and Emission Components [258](#)
Install Engine Belt [245](#)
Installing Batteries [240](#)
Instrument Cluster [52](#)

J

Jump Starting [38](#)

K

Key Fob [242](#)
Keyless Entry [242](#)

L

Lamp Self Test [103](#)
Lamp Test [103](#)
Lamps, Headlamps Flashing, Aftertreatment Warning [154](#)
Lane Departure [127](#)
Lane Departure Mute [92](#)
Lane Departure Warning [128](#)
Lane Departure Warning (LDW) [82](#)

Language

English [64](#)
French [64](#)
Spanish [64](#)

LDWS [127](#)
Light Self Test [103](#)
Lights [93](#)
Lights Marker Clearance [101](#)
Lights, High Beam [82](#)
Locking the Fifth Wheel, See How to Lock the Kingpin
Low Air Alarm [33](#)
Low Air Leaf Fastener Torque Value Rear Suspension Fasteners [281](#)
Low Oil Pressure Lamp [34](#)
Lubricants [208](#)
Lubrication Specification Chart [276](#)
LVD, See Low Voltage Disconnect

M

Maintenance Manuals [12](#)
Maintenance Schedule [171](#)
Manifold Pressure Gauge [83](#)
Manual Kingpin Release Fifth Wheel Operation [156](#)
Manually lock a differential [45](#)
Menu [64](#)
Meritor Axle Lubrication [263](#)
Metric Units [64](#)
minimized view 2 [59](#)
Mirror Controls [97](#)
Mirror switch [97](#)

Mud [48](#)

N

New Vehicle Maintenance Schedule [169](#)
New Vehicle Maintenance Schedule: First 2,000 mi / 3,218 km [170](#)
New Vehicle Maintenance Schedule: First 50-100 mi / 80-160 km [169](#)
New Vehicle Maintenance Schedule: First 500 mi / 800 km [170](#)
New Vehicle Maintenance Schedule: First Day [169](#)
New Vehicle Maintenance Schedule: First 3,000-5,000 mi / 4800-8000 km [170](#)
Noise and Emission Control [257](#)
Noise Control System - Maintenance Log [283](#)
Notifications [64](#)

O

Odometer [58](#)
Off-Road ABS Function Switch (Optional) [141](#)
Oil Level [209](#)
Outside Air Temperature [56](#)
Overflow tank [228](#)

P

PACCAR 20k Front Axle Lubrication [254](#)
PACCAR Shifter [99](#)
PCC [129](#)
Pipe and Hose Clamp Torque Values [274](#)
power distribution box [236](#)
Power Steering Fluid [266](#)
Power Take Off [122](#)
Pre-Trip Inspection [25](#)
Predictive Cruise Control [129](#)
Predictive Cruise Control Behavior [129](#)
Predictive Cruise Control Controls [130](#)
Predictive Cruise Control Interrupt [130](#)
Predictive Cruise Control Set Undershoot [130](#)
Predictive Cruise Control Software Information [130](#)

Predictive Cruise Control Troubleshooting [130](#)
Predictive Cruise Overshoot [64](#)
Prepare the Axles for Towing [44](#)
Program Key Fobs [242](#)
PTO [122](#)
PTO indicator [121](#)

R

Rear Axle Alignment [261](#)
Rear Axle and Suspension [259](#)
Rear Axle Lubrication [261](#)
Rear Suspension U-Bolts, Grade 8 [280](#)
Recovery Hitch [43](#)
Recovery hitch capacities [46](#)
Recovery hitch How to use tow pin [44](#)
Recovery hitch Best practices [47](#)
Recovery hitch Prepare axles [44](#)
Refrigerator [83](#)
Release Kingpin Fifth Wheel Operation [156](#)
Releasing the Kingpin, See How to Release the Kingpin from the Cab
Remote Keyless Entry [242](#)
Removing Batteries [239](#)
Repairs [12](#)
Replace Battery Box Cover [240](#)
Replacing the Engine Air Intake Filter [247](#)
Replacing the Primary Fuel Filter [249](#)
Returning to Service after Recovering [47](#)
Roadside Assistance [33](#)
Roll Stability [139](#)
Roll Stability Example [139](#)

S

Safety [7](#)
Safety Alerts [7](#)
Safety Restraint System - Inspection [230](#)
Sand [48](#)
Scroll Wheel [54](#)

Seat

- Komfort Latch [23](#)
- Lap/Shoulder Belt [22](#)
- Safety Restraint Belts [19](#)
- Tether Belts [22](#)
- Seat Belt Fasten [83](#)
- Seat with Air Suspension [19](#)
- Set Shut Down Timer [131](#)
- Settings [64](#)
- Shortcuts [68](#)
- Shut Down Timer [65](#)
- Sleeper Bunks [161](#)
- Sleeper Bunks and Restraints [24](#)
- Sliding Fifth Wheels [252](#)
- Sliding the Fifth Wheel, *See* How to Slide the Fifth Wheel
- Slow Battery Charging [241](#)
- Snow [48](#)
- Specific Cruise Indicator [78](#)
- Speedometer [59](#)
- Stability Control [76, 77](#)
- Standard Units [64](#)
- Steering Shaft Bolt Torque Specifications [267](#)
- Steering System [265](#)
- Steering Wheel Controls [102](#)
- Steering Wheel Pod Use [54](#)
- Stop Engine Light [34](#)
- Stopping Procedures [163](#)
- Sub-trip Odometer [57](#)
- Suppressing Popups [73](#)
- Surge tank [228](#)
- Suspension U-Bolts [280](#)
- Systems Check [30](#)

T

- Tachometer [59, 161](#)
- Testing Exterior Lamps [103](#)
- Tilt Telescope [99](#)
- Time [64](#)
- Tips for Efficient Cooling [107](#)

- Tire Inflation [83, 267](#)
- Tire Pressure Monitoring System [30](#)
- Tires [267](#)
- Topping Up the Engine Oil [244](#)
- Tow Pin [43](#)
- Towing Doubles Or Triples May Reduce The Effectiveness Of Stability Systems [143](#)
- Towing the Vehicle [48](#)
- TPMS [30](#)
- Traction Control [94](#)
- Trailer Hand Brake [90, 137](#)
- Trailer Hand Brake Dash Switch [137](#)
- Transmission Gear Display [58](#)
- Transmission, Auxiliary [83](#)
- Transmission, Check [83](#)
- Transmission Maintenance [272](#)
- Trip Odometer [57](#)
- Trip Summary [64](#)
- Truck Information [69](#)
- Turbocharger [246](#)
- Turn Signal [99](#)
- Turn Signal, Left [83](#)
- Turn Signal, Right [83](#)

U

- Under Cab Battery Access [239](#)
- Unlock Fifth Wheel, *See* How to Release the Kingpin from the Cab
- Unlocking the Fifth Wheel/Fifth Wheel Operation [156](#)
- Using the Telematic System [113](#)

V

- Variable Road Speed Limiter [125](#)
- Variable Speed Limiter/How to Set the Variable Speed Limiter [126](#)
- Vehicle Emissions Limited Express Warranty [294](#)
- Vehicle ID Labels [287](#)
- Vehicle is stuck [48](#)
- Vehicle Light Bulb specifications [235](#)
- Vehicle Loading [26](#)

Index

View Indicator [57](#)

Visual inspection while approaching the vehicle [27](#)

W

Warm Up, Engine [118](#)

Warning Icons [73](#)

Weekly Checks [29](#)

What is an Air Compressor [216](#)

What is Engine Aftertreatment [132](#)

What is the Air System [210](#)

What to do before starting the vehicle [25](#)

Wheel Cap Nut Torque Specifications [275](#)

Wheels [271](#)

Windsheid Wiper Interlock [65](#)

Windshield Washer [101](#)

Windshield Wiper [101](#)

Windshield Wiper/Washer [233](#)

Y

Yaw Control [140](#)

Yaw Control Example [140](#)

Yaw Stability [139](#)

PETERBILT MOTORS COMPANY

A PACCAR Company

P.O. Box 90208

Denton, Texas 76202

Do not remove the manual from vehicle.

Before operating vehicle study the manual carefully.

Read and understand all warnings, cautions and notes.

Need help? Give us a call 24 hours a day

1.800.4.PETERBILT



SCAN THIS QR CODE
TO ACCESS ONLINE
DRIVER RESOURCES.
peterbilt.com/driver-resources



Y53-6076-1D1

Printed in the U.S.A. 09/20